

# SELENE

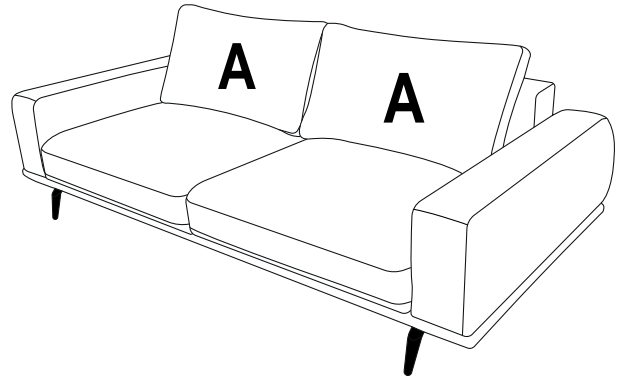

I

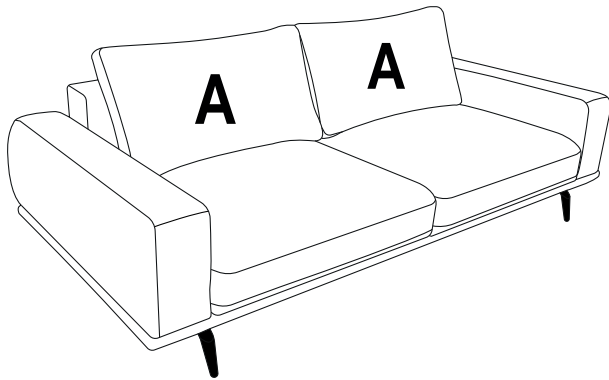
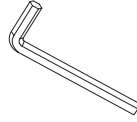
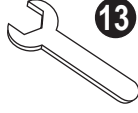
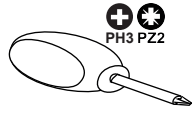
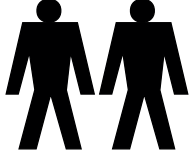
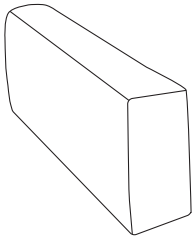

II

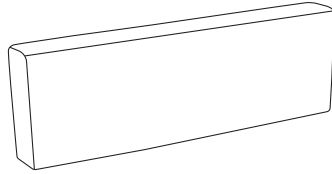

III

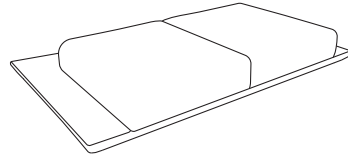

IV

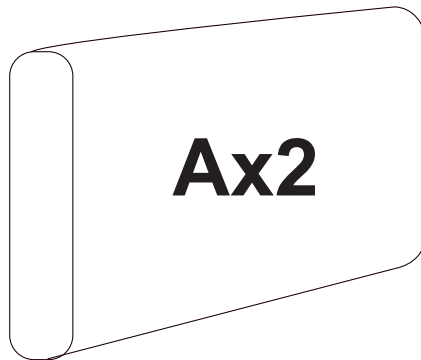
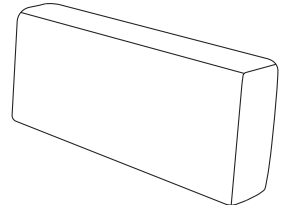

**Bx4**

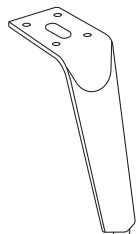

**H=150 mm**

**Cx16**

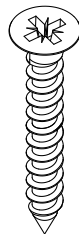

**5x40**



**PZ2**

**Dx4**

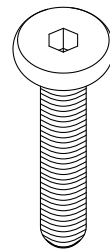

**8x25**

1

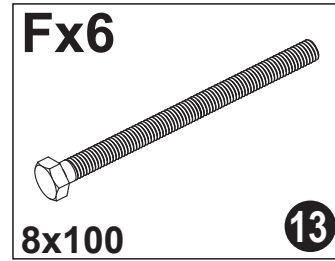
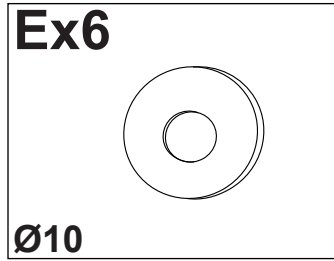
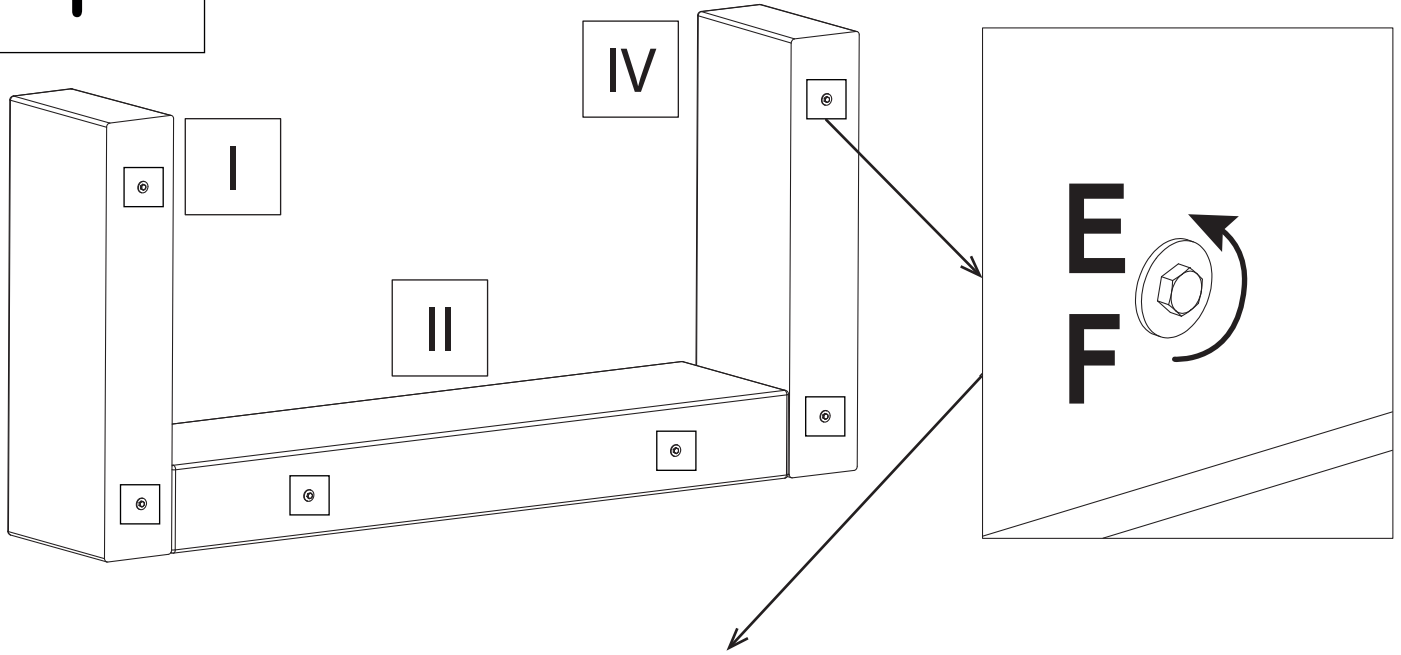

2

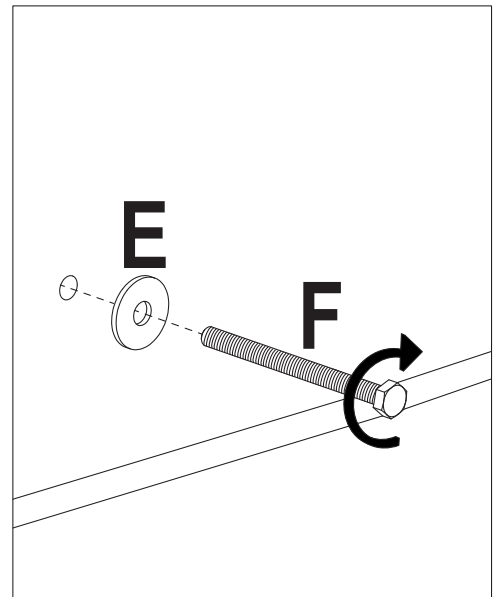
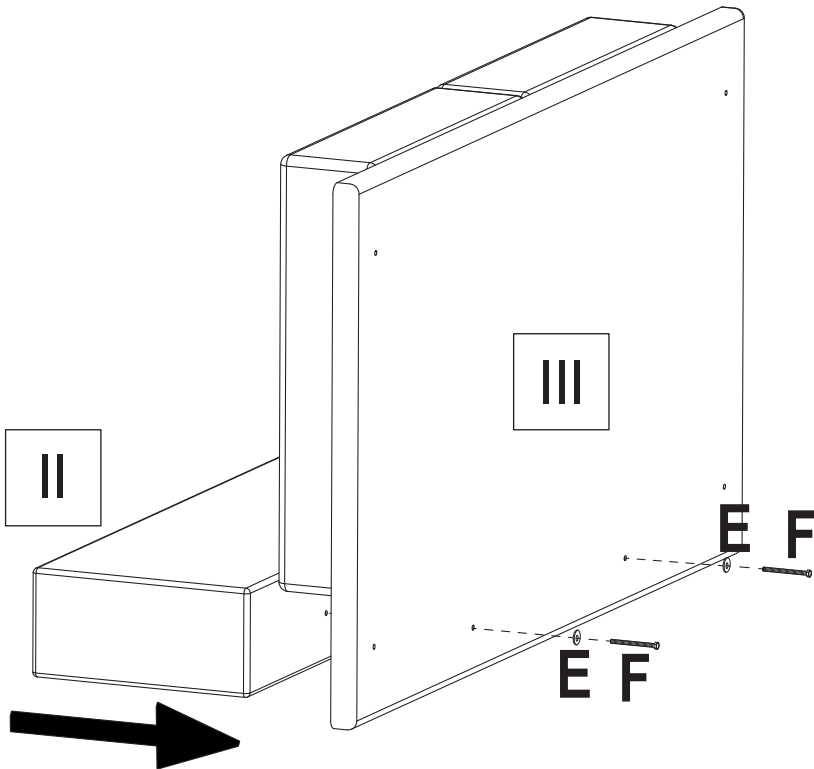
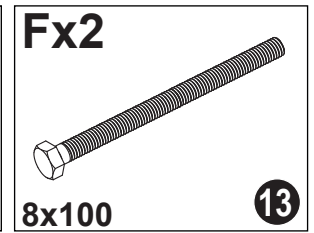
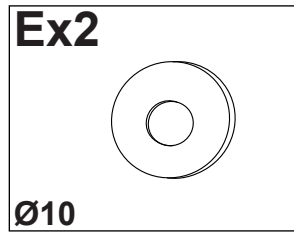

3

Ex4

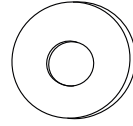

Ø10

Fx4

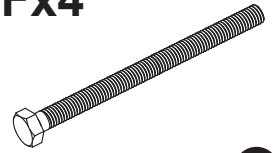

8x100

13

IV

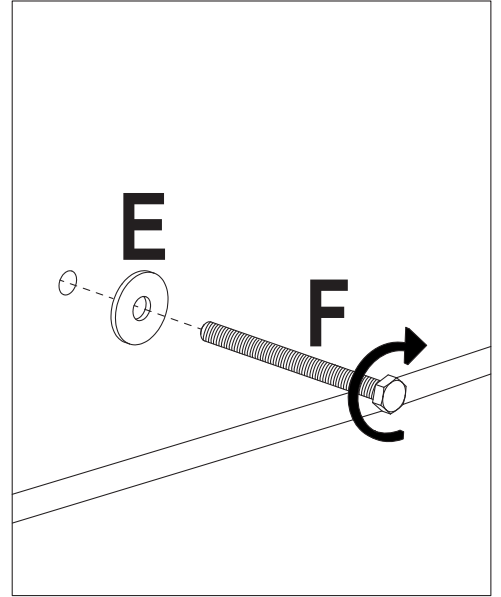
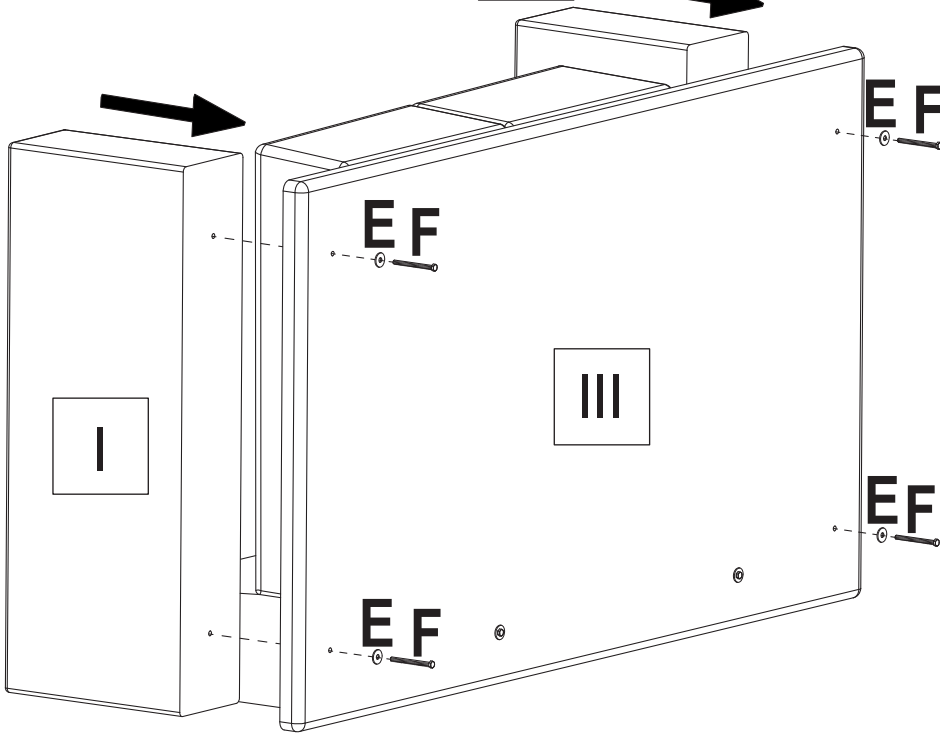

4

Bx4



H=150 mm

Cx16



5x40



Dx4

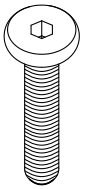

8x25

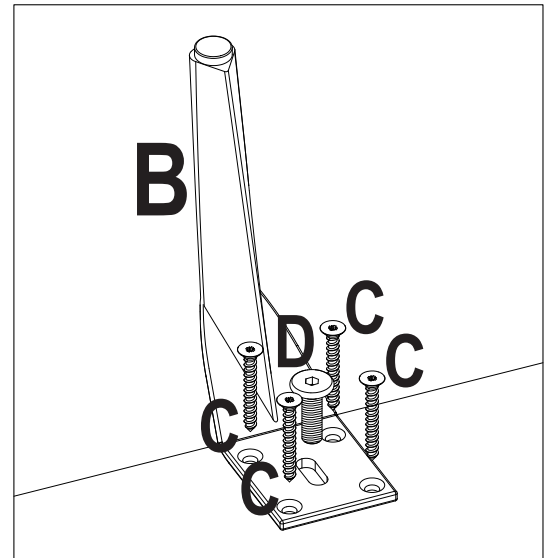
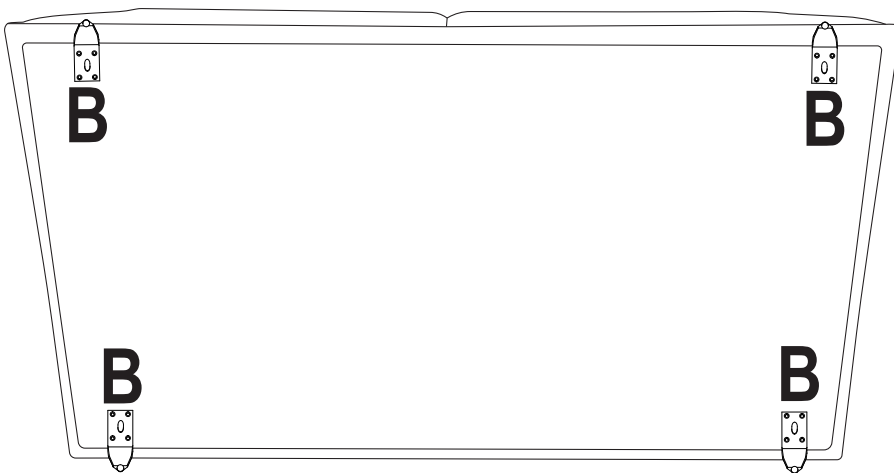

5

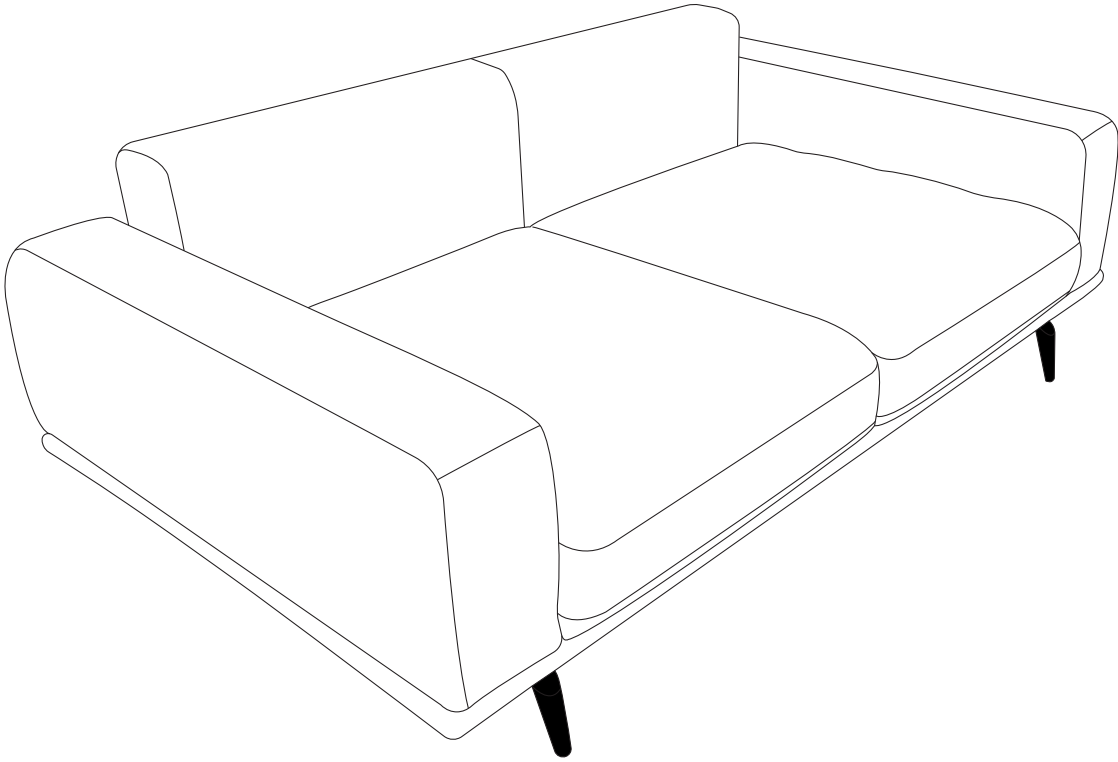

6

