

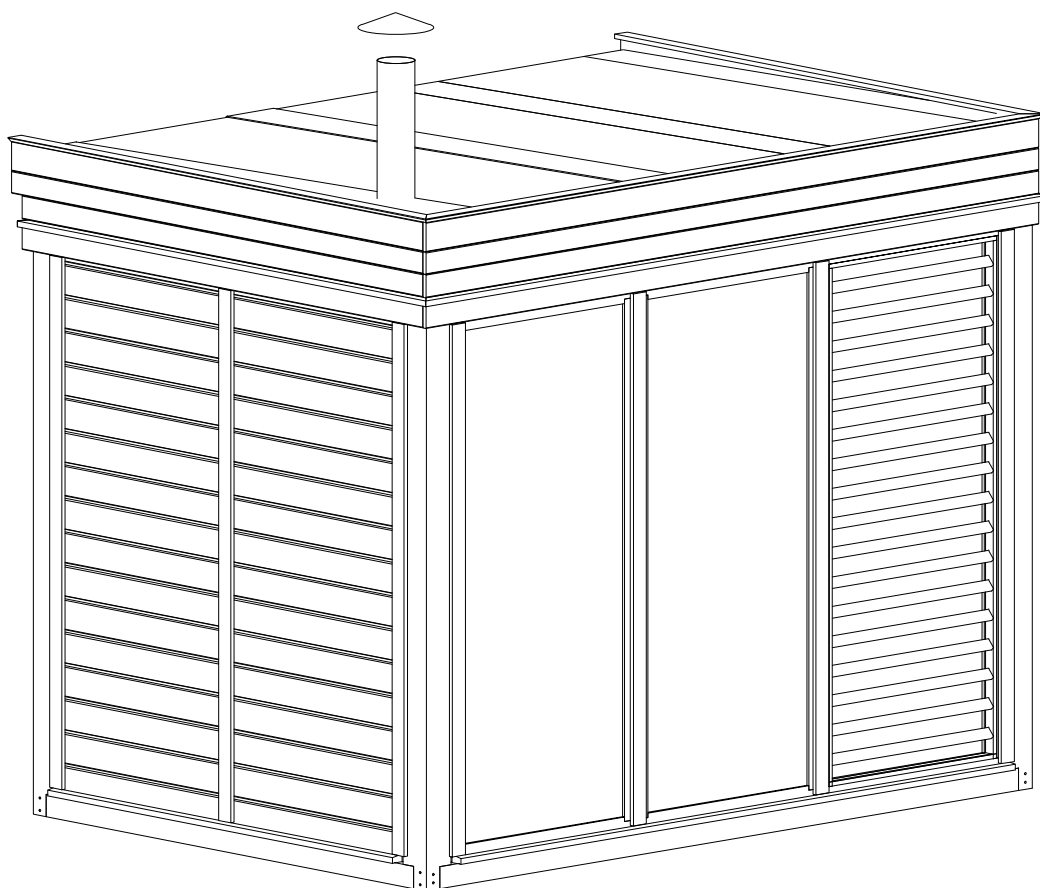











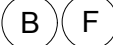







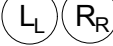



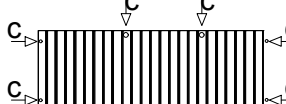
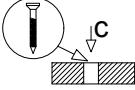

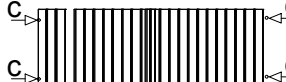

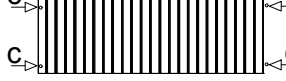
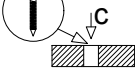







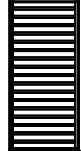

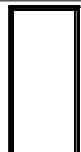

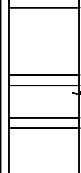

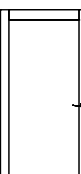









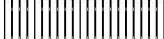







Sauna Cube 3 x 2 with changing room



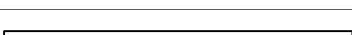









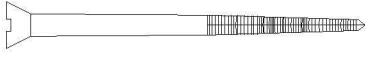
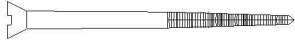
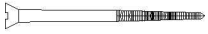







1. Sauna Cube 3 x 2 with changing room

No.	Detail	Pcs	
			2
			2
			4
			2
			2
			1
			1
			1
			2
			5
			1
			2
			1
			1







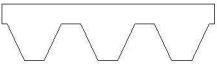
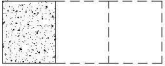

2. Sauna Cube 3 x 2 with changing room

No.	Detail		Pcs	
a		□	20	
b		□	5	
F		┌	8	F1,F2,F3,F4, F5,F6,F7,F8
B		┌	6	B1,B2,B3,B4,B5,B6
L		┌	8	L1,L2,L3,L4, L5,L6,L7,L8
R		┌	8	R1,R2,R3,R4, R5,R6,R7,R8
SB ₁			1	
SB			1	
1		-	4	
2		-	8	
3		-	4	
5		-	6	
6		┌	17	
7		□	20	inside and outside
7.1		□	2	
7.2			2	
7.3			2	
7.4		┌	2	
7.5		┌	2	
8		┌	6	
10		□	2	

3. Sauna Cube 3 x 2 with changing room

No.	Detail	Pcs	
A0		30	
A1		12	
A2		—	
A3		—	
A4		32	
A5		116	
A6		—	
A7		—	
A8		512	
A9		—	
A10		—	
A11		32	
A12		—	
A13		—	
A14		—	
A15		—	
A16		20	
A17		1 pack	
A18		1 pack	
A19		—	
A20		1 pack	

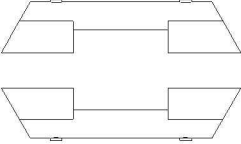
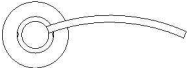
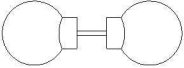
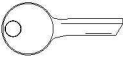
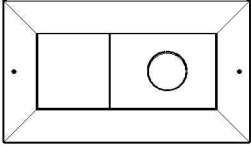
4. Sauna Cube 3 x 2 with changing room

No.	Detail	Pcs	
S1		—	
S2		—	
S3		—	
S4		—	
S5		—	
S6		—	
S7		3	
S8		4	
T1		1	
T2		1	
T3		—	
T4		1	
T5		1	
T6		1	
T7		—	

Sauna cube 3 x 2 with changing room
foundation

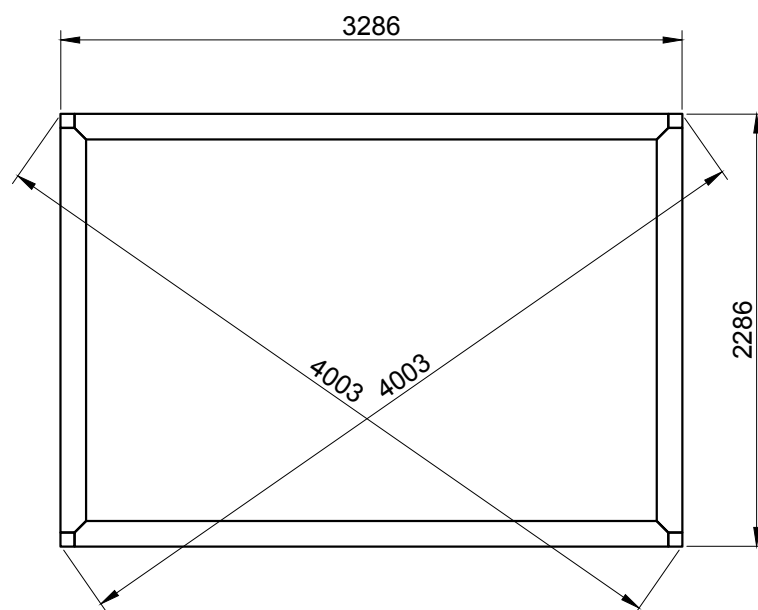
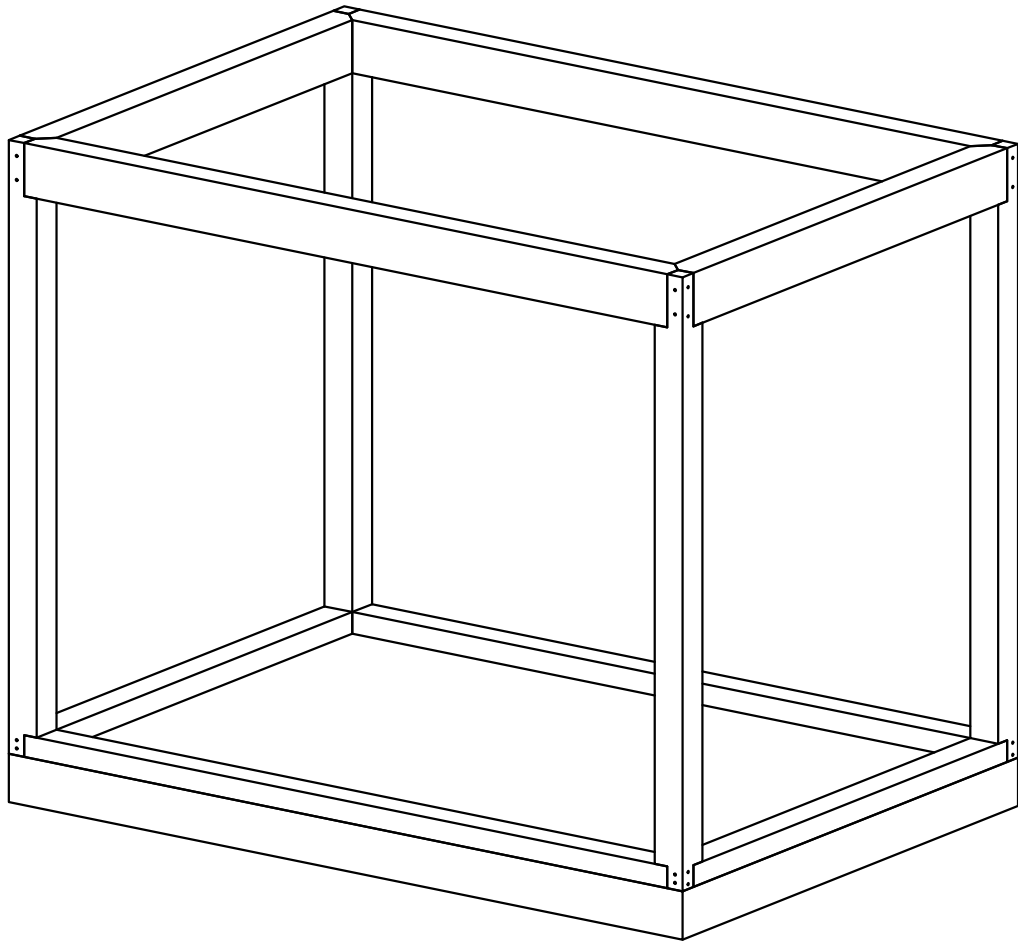

1. Sauna cube 3 x 2 with changing room

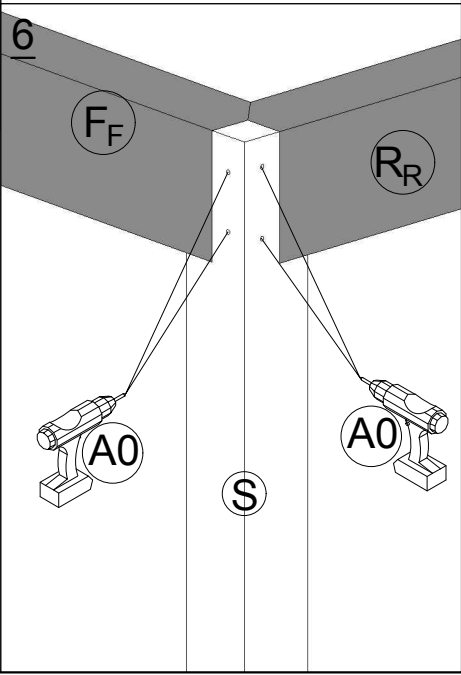
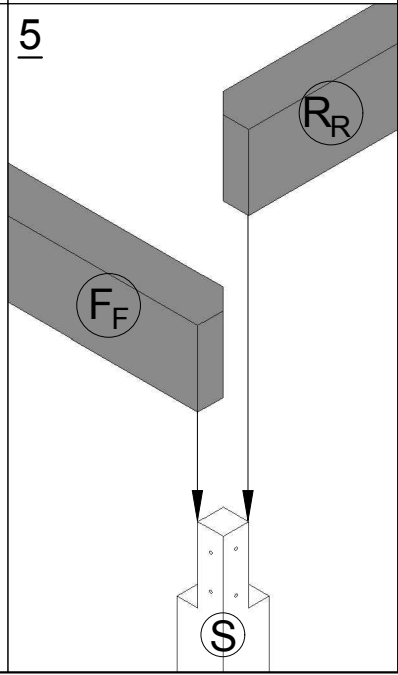
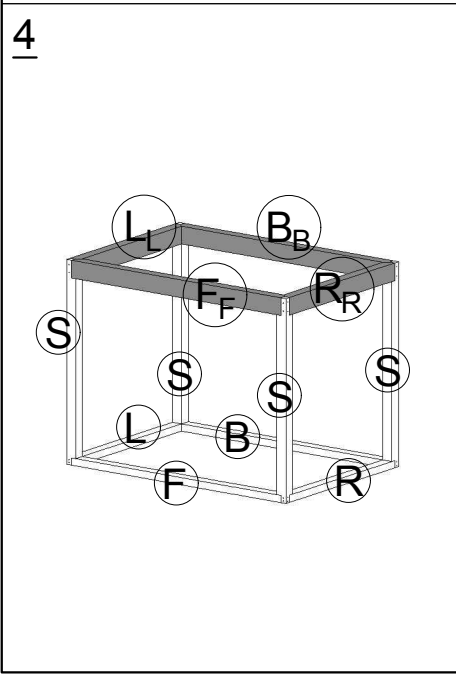
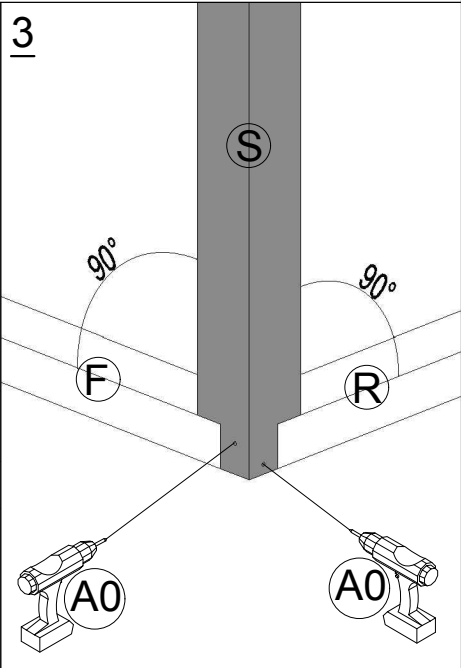
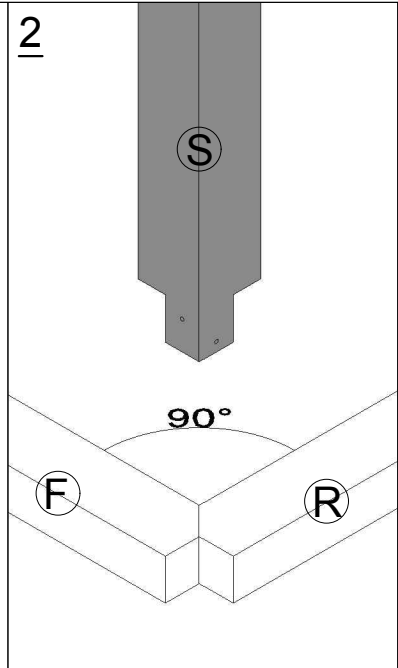
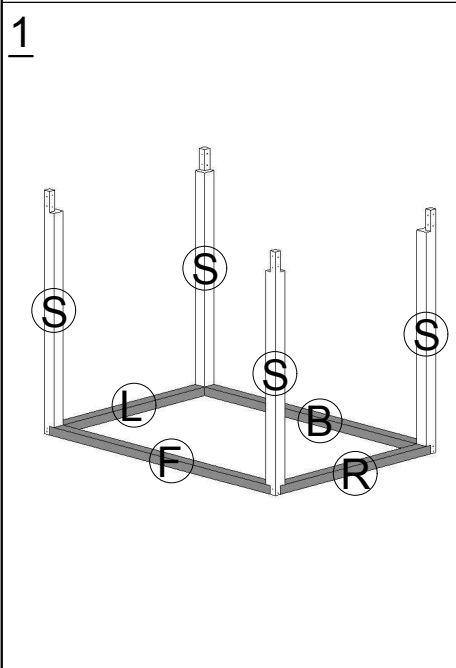
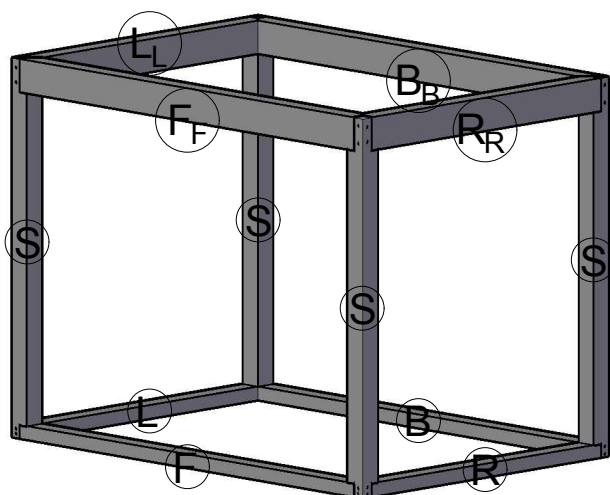

2. Sauna cube 3 x 2 with changing room

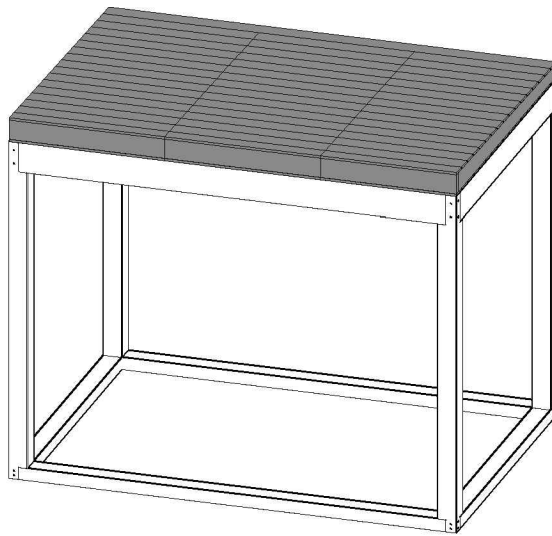

1

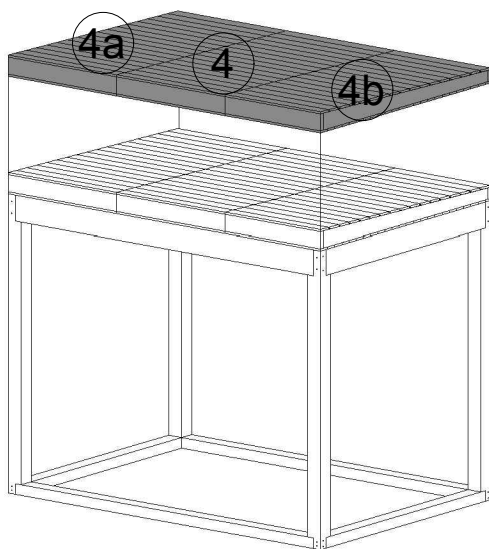

2

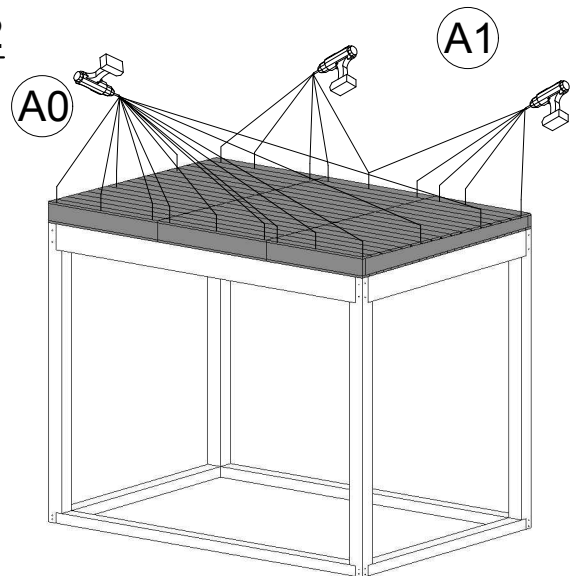

3

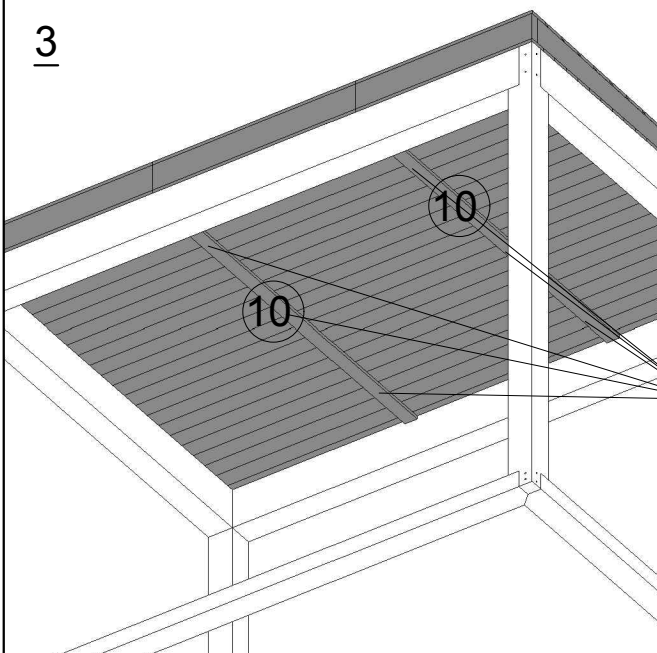

4

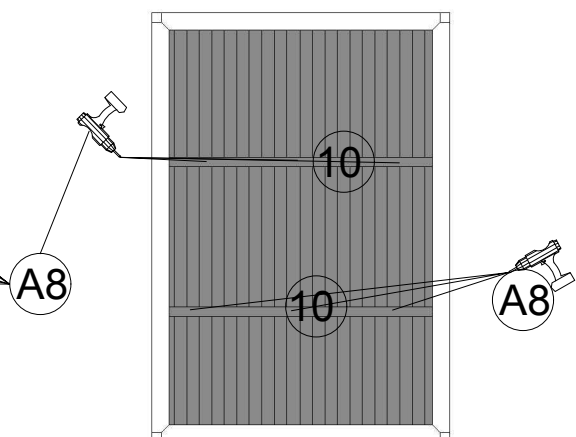

3. Sauna Cube 3 x 2 with changing room

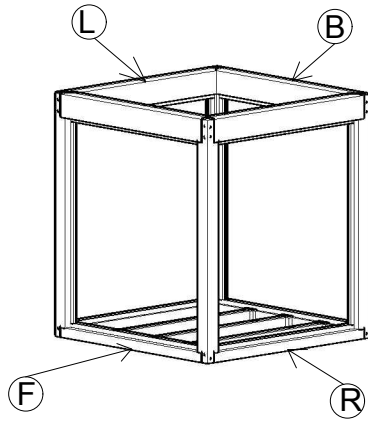

Right view (R)

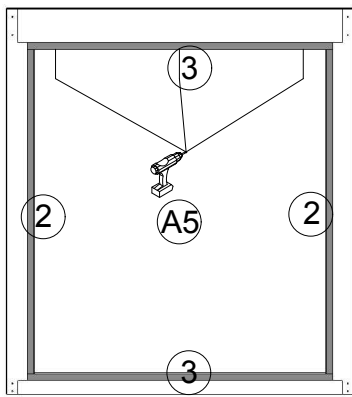

Front view (F)

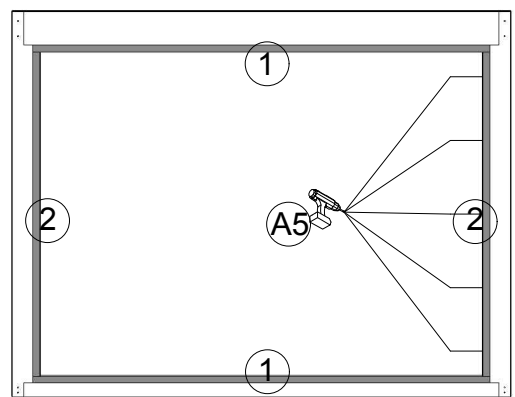

Left view (L)

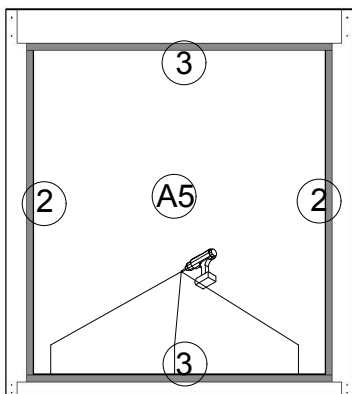

Back view (B)

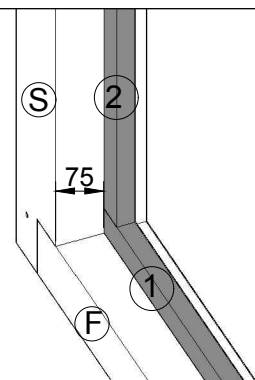
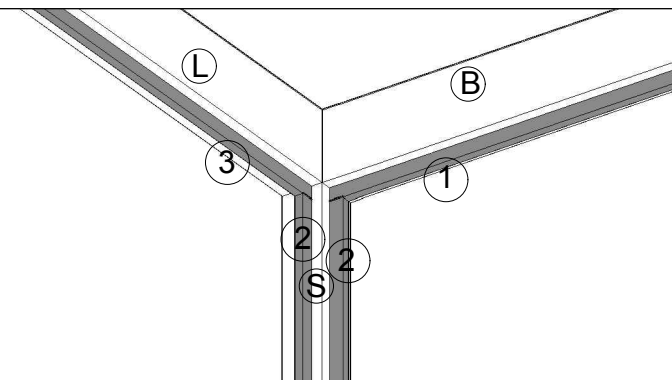
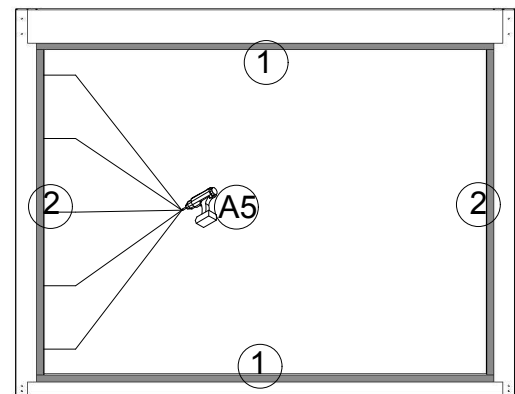

4. Sauna Cube 3 x 2 with changing room

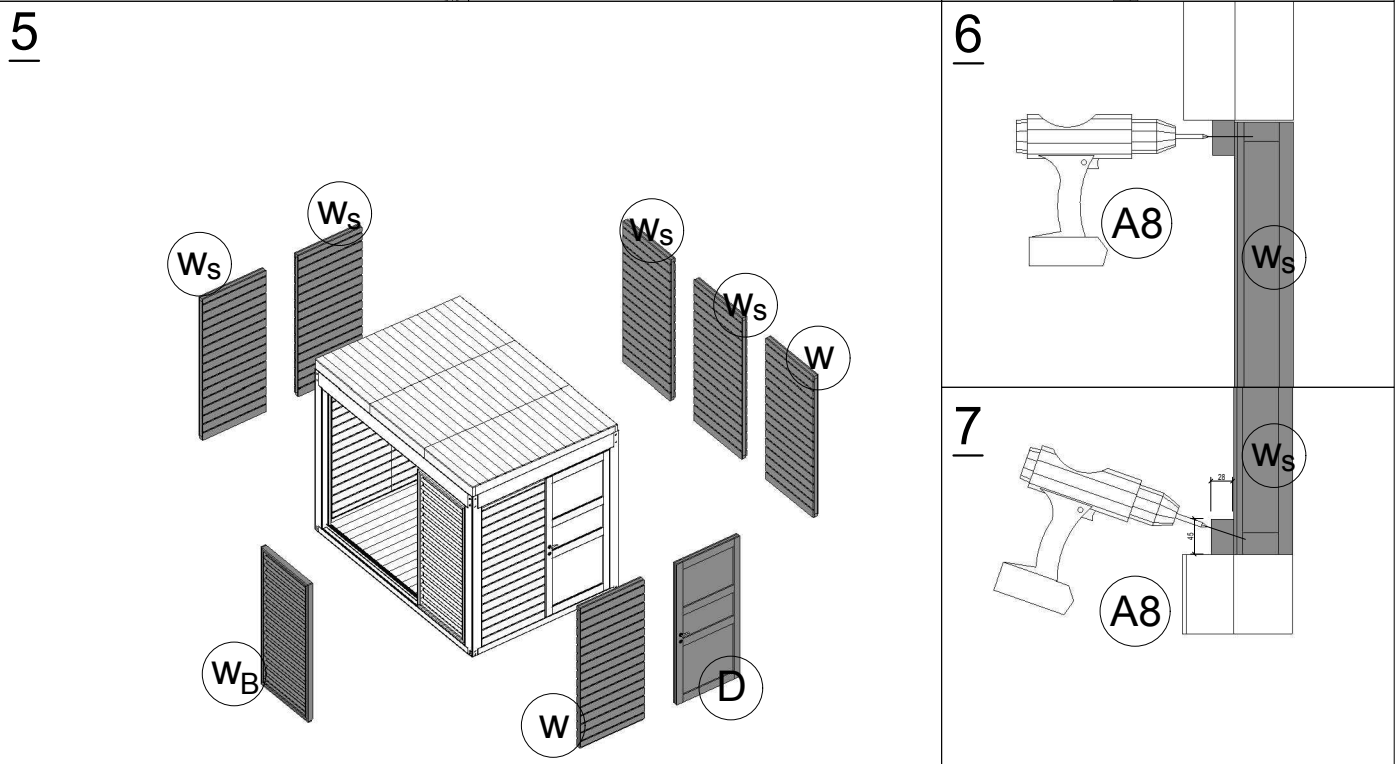
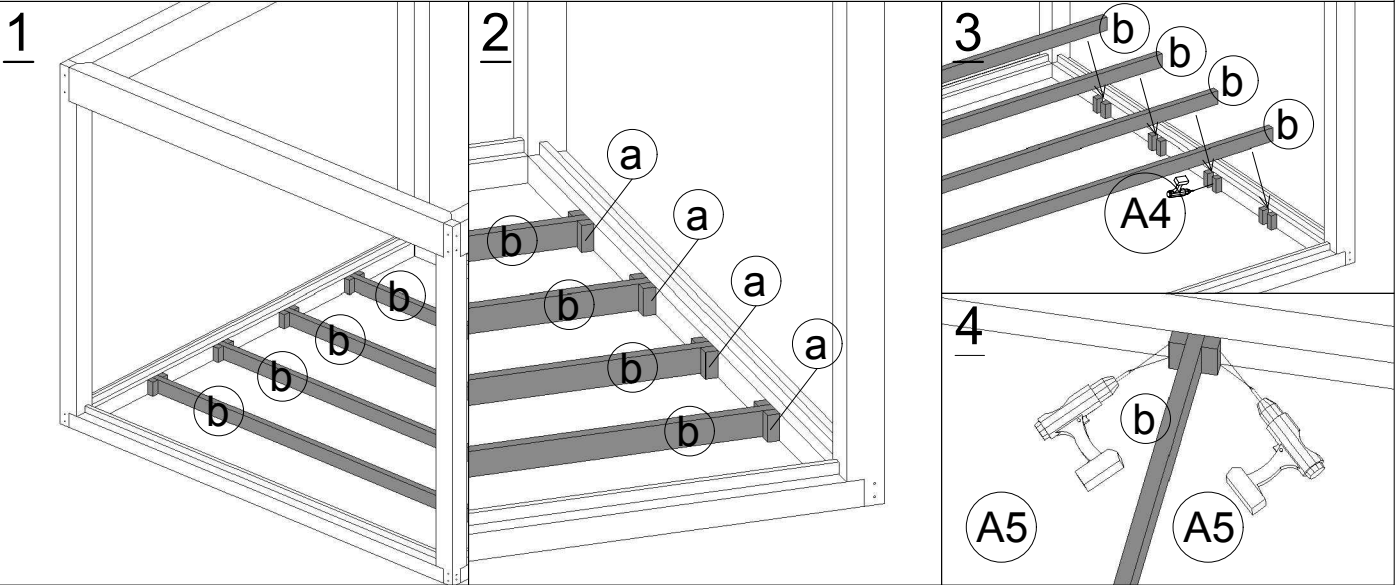
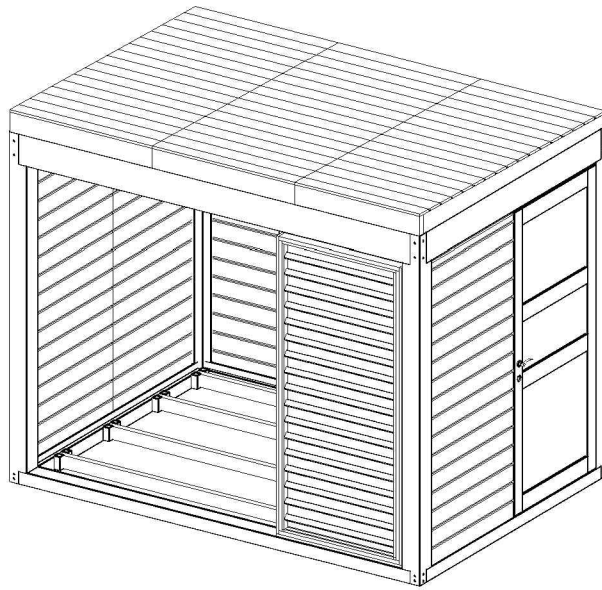

5. Sauna Cube 3 x 2 with changing room

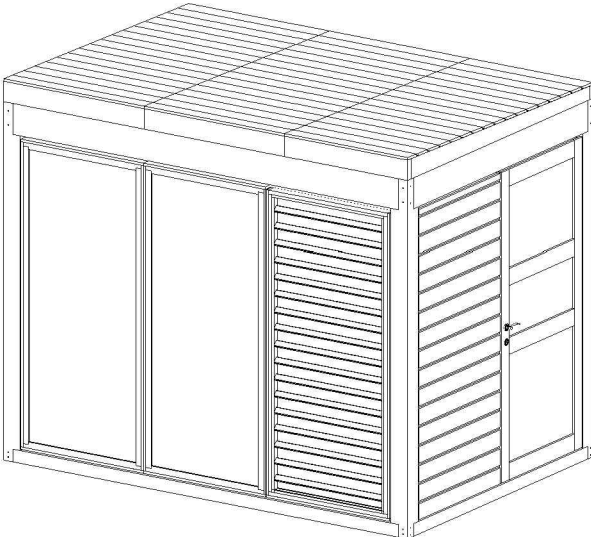

1

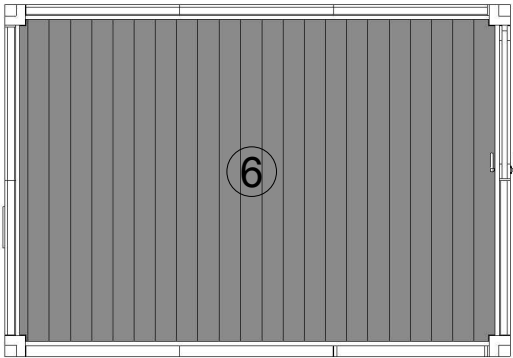

2

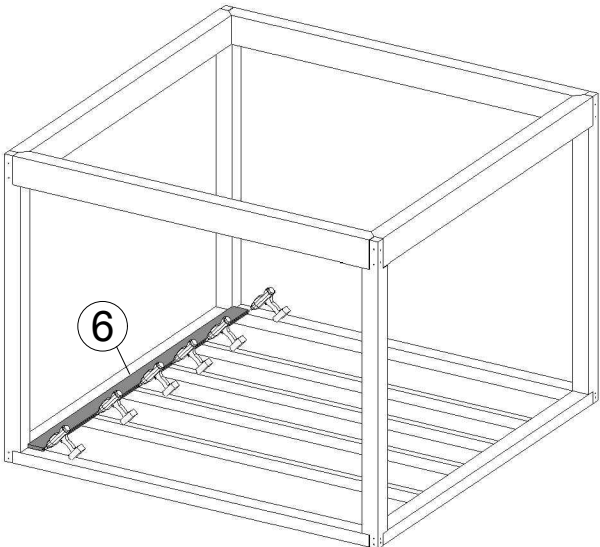

5

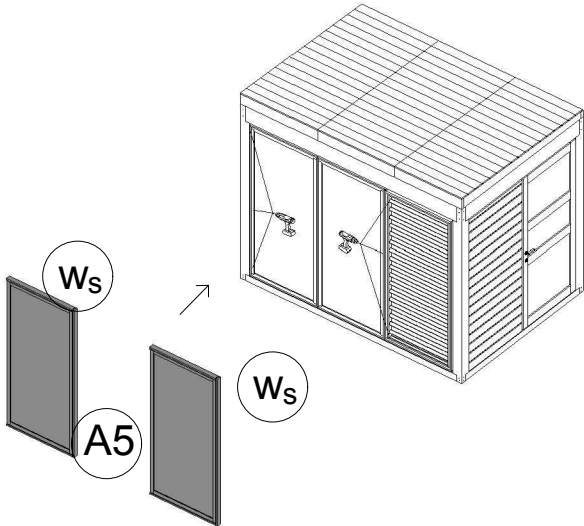

3

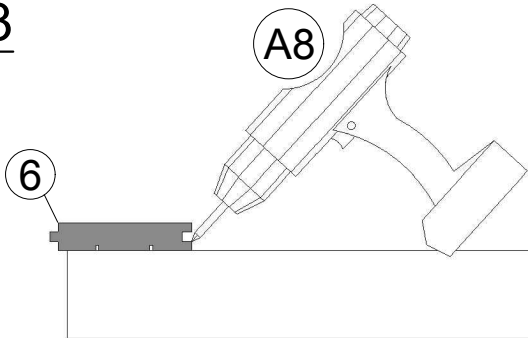

4

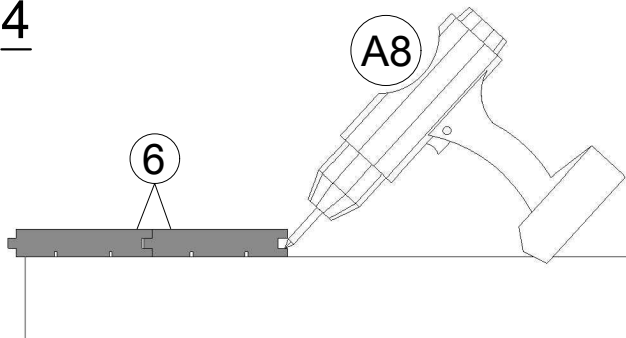

6. Sauna Cube 3 x 2 with changing room

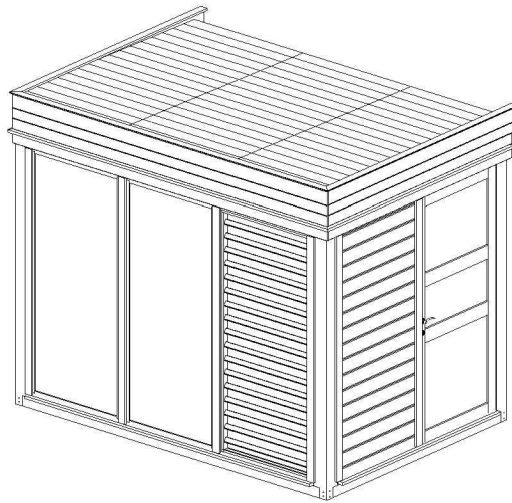

1

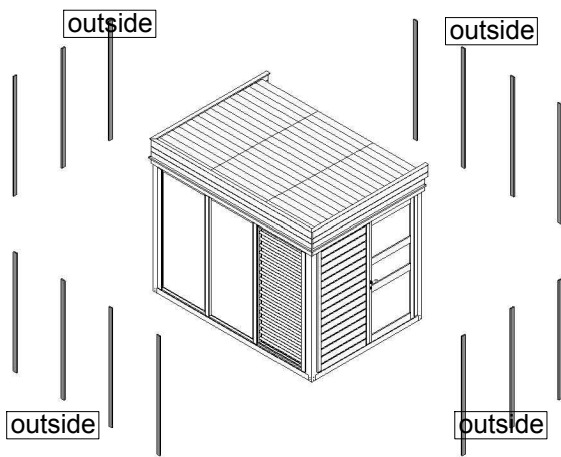

2

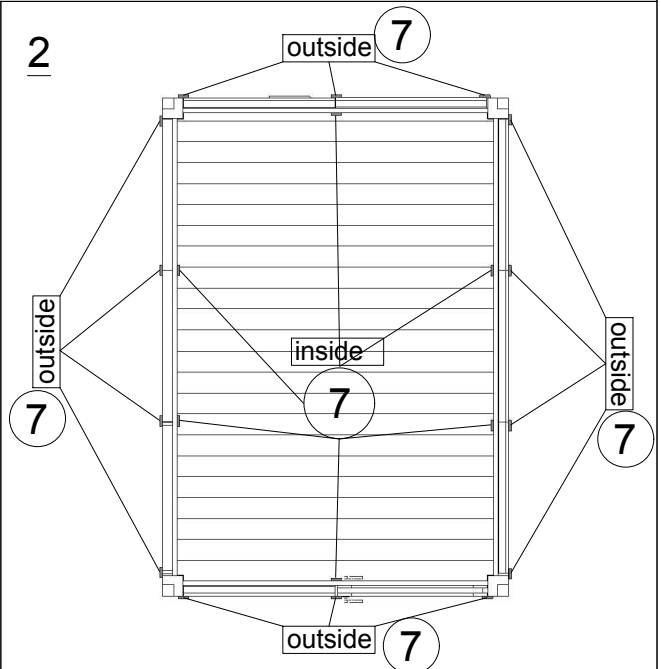

3

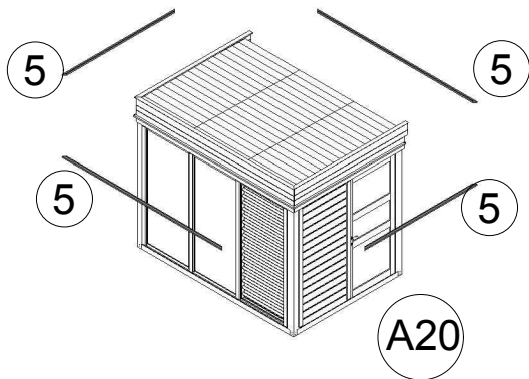

4

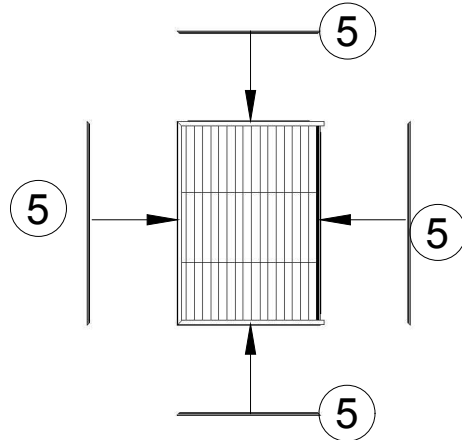

5

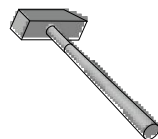
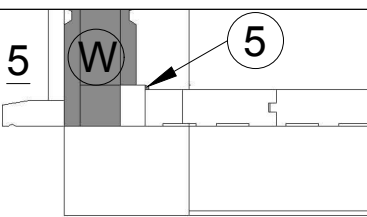

6

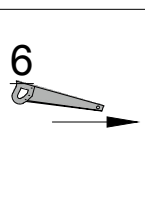

7

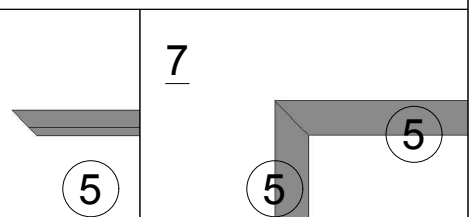

7. Sauna Cube 3 x 2 - Front side

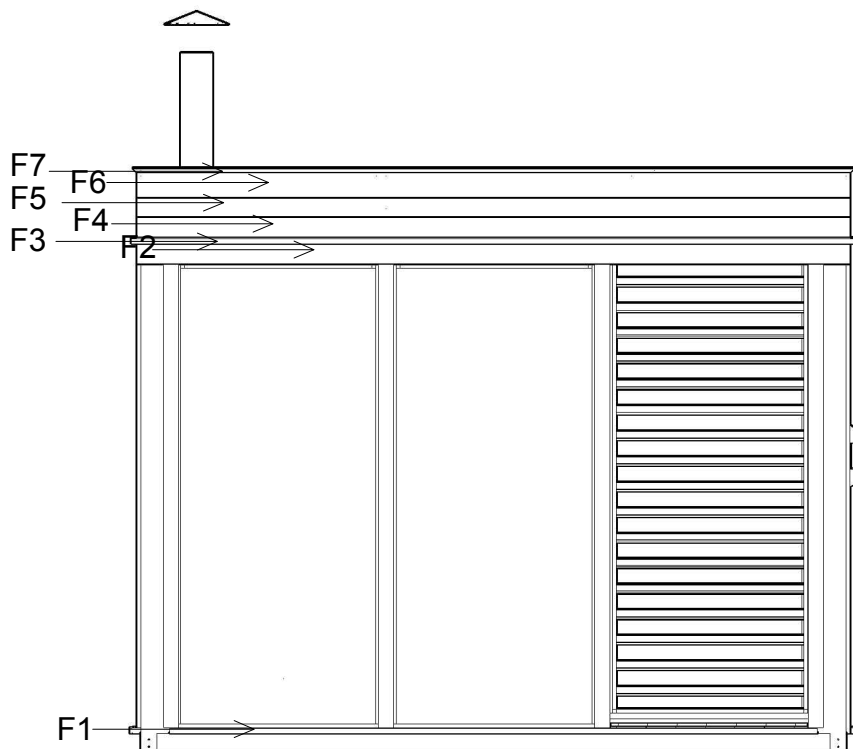
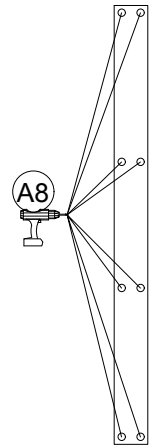
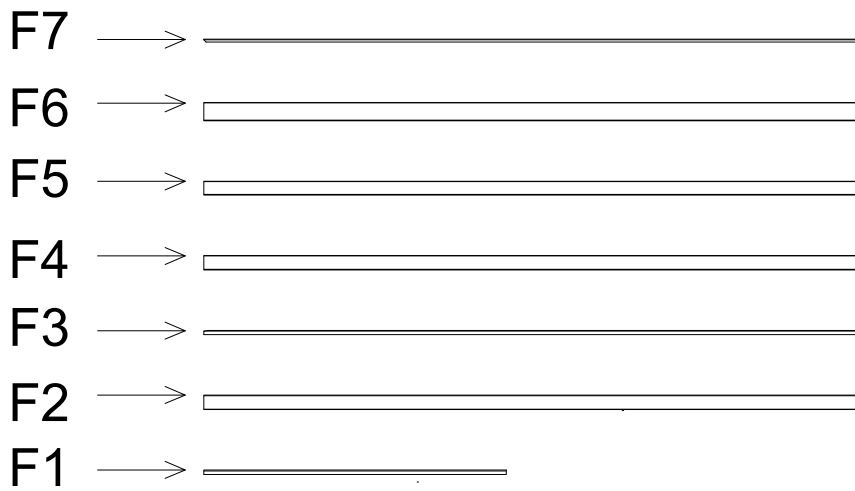
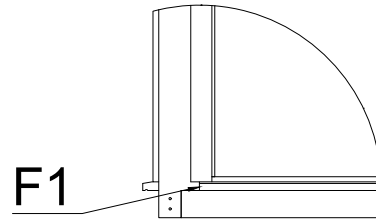
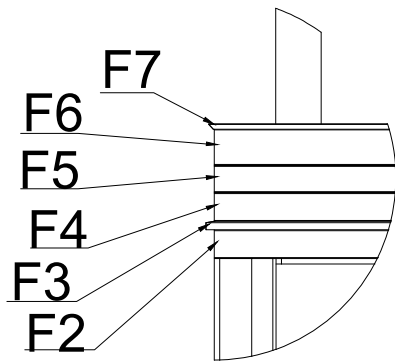

8. Sauna Cube 3 x 2 - Left side

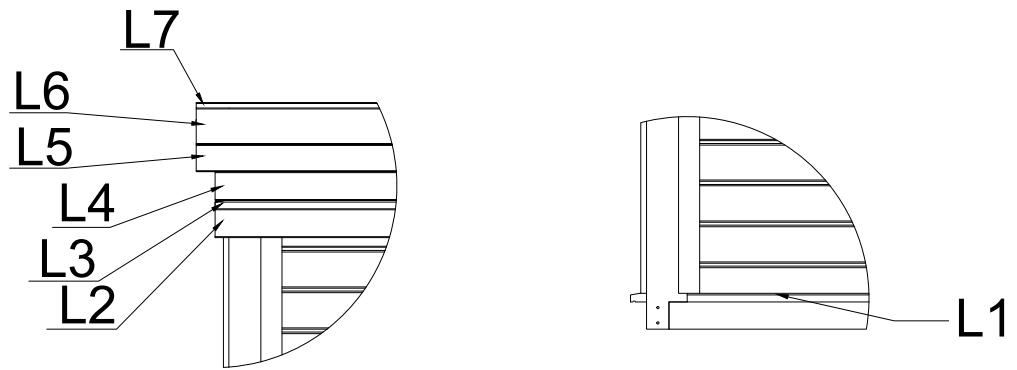

- L7 →
- L6 →
- L5 →
- L4 →
- L3 →
- L2 →
- L1 →

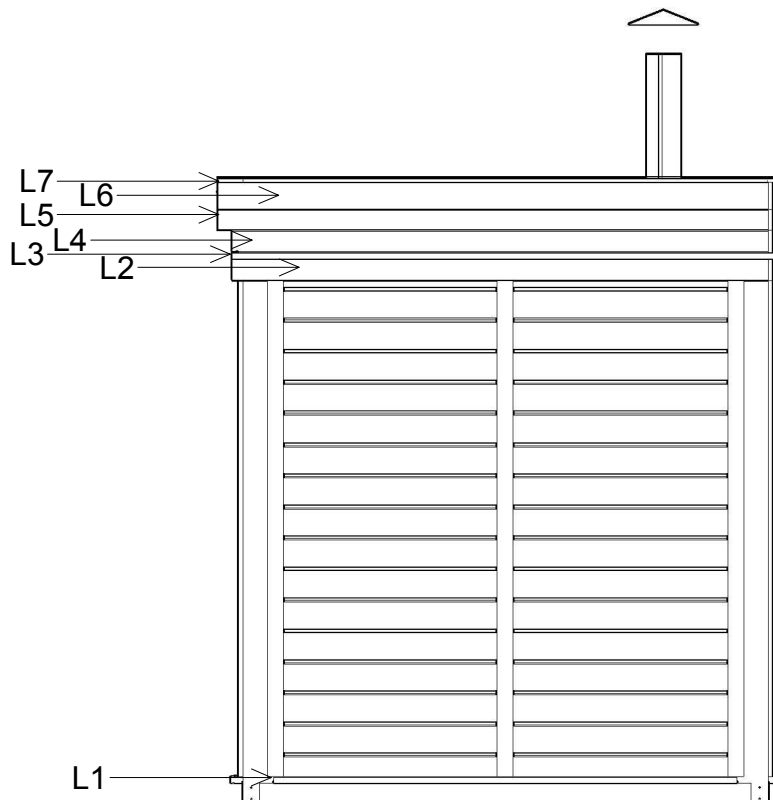
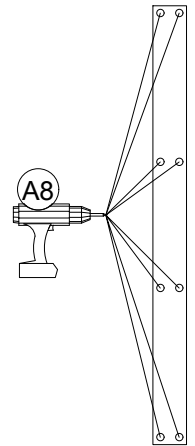

9. Sauna Cube 3 x 2 - Right side

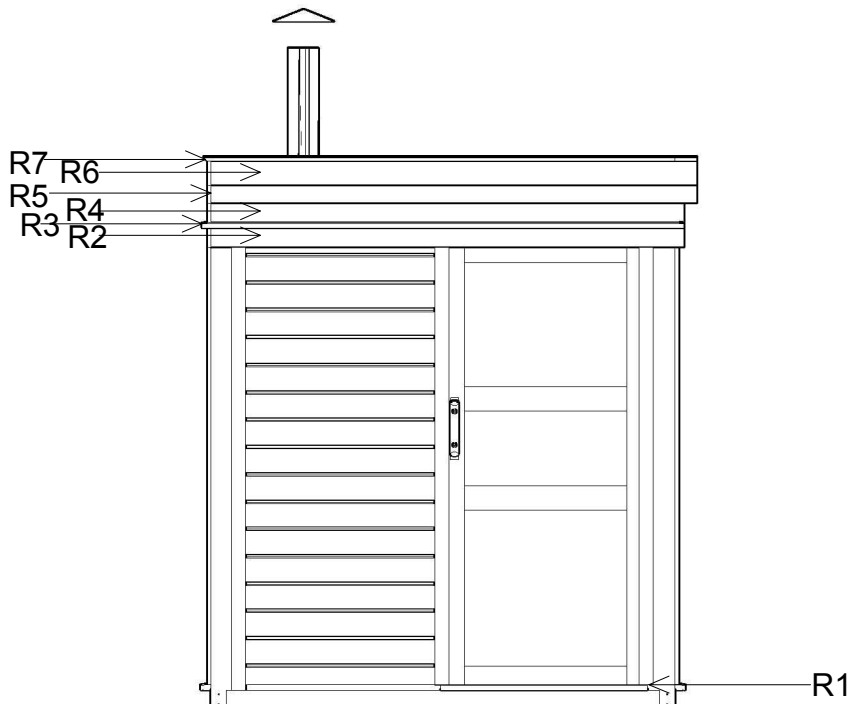
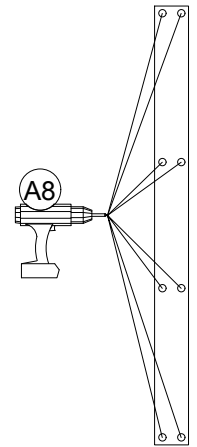
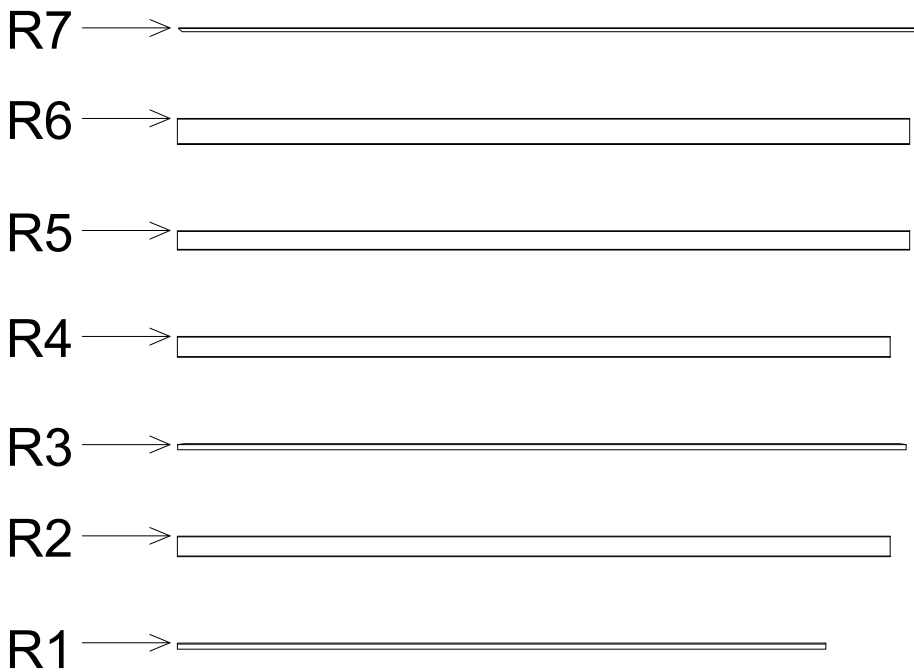
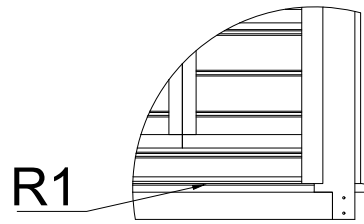
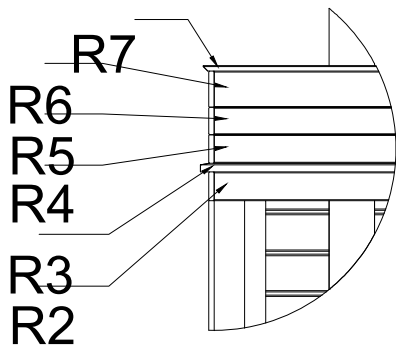

10. Sauna Cube 3 x 2 - Back side

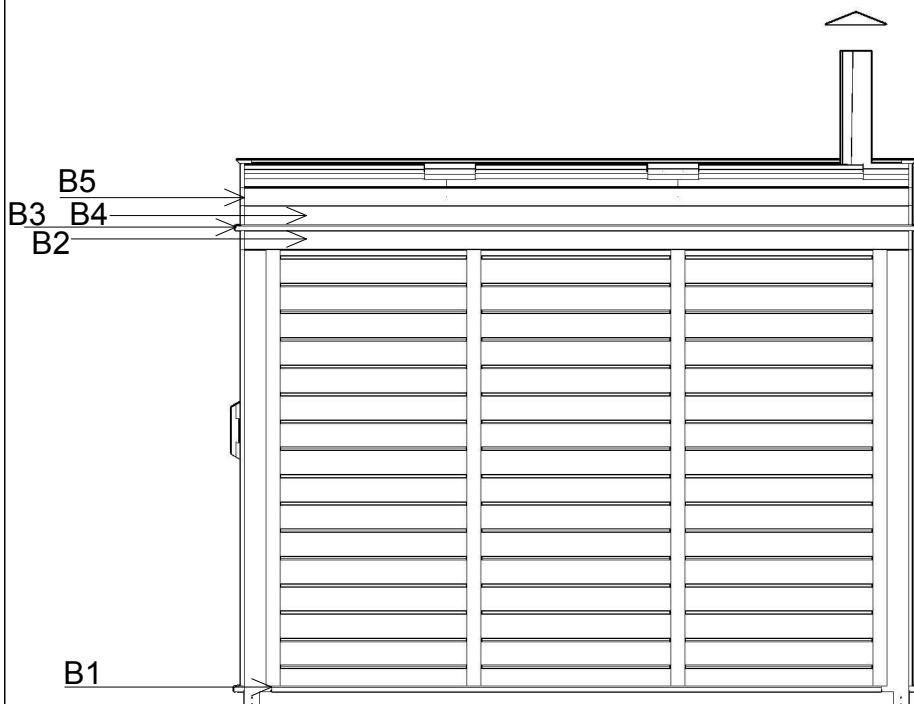
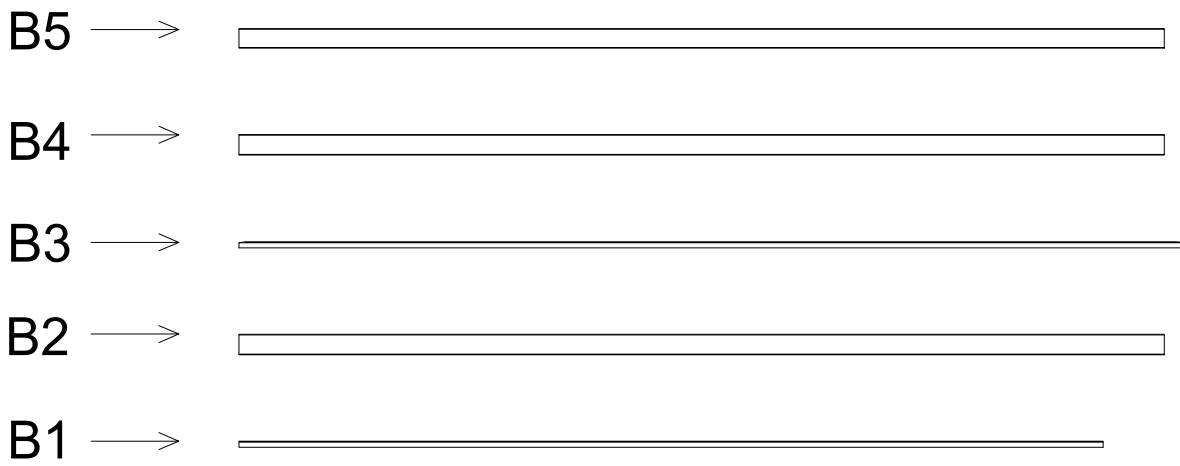
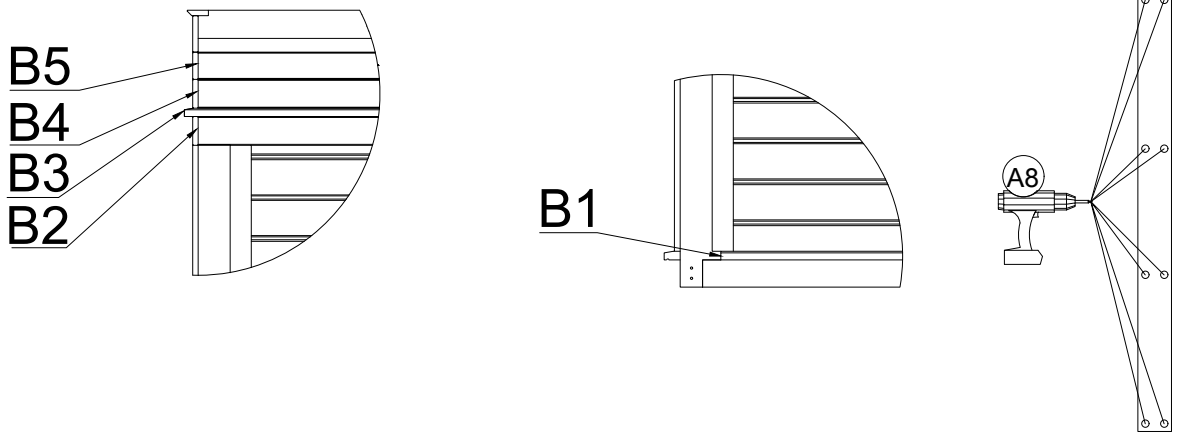

11. Garden cube 3 x 2 with changing room

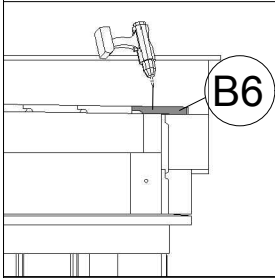
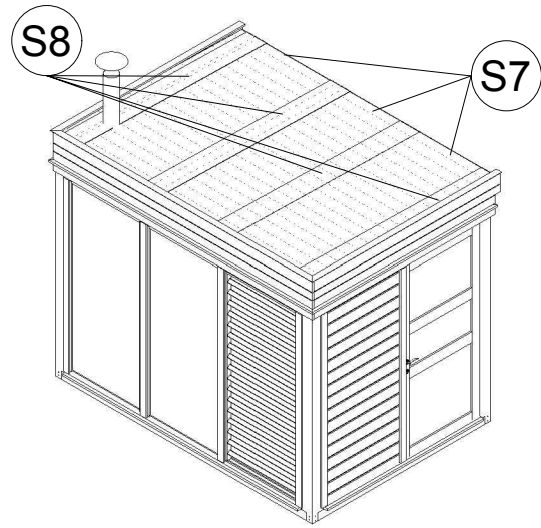

<p>1</p> <p>Diagram showing the garden cube with roof components B6 and A7.</p>	<p>2 Bitumen shingles</p> <p>Diagram showing the application of bitumen shingles A17 to roof component S7.</p>	<p>3</p> <p>Diagram showing the application of bitumen shingles S8 to the roof.</p>
<p>4</p> <p>Diagram showing bitumen shingles S8.</p>	<p>5</p> <p>Diagram showing the garden cube with roof components F8, R8, and L8.</p>	<p>6</p> <p>Diagram showing the application of component A11 to roof component S8 using a screwdriver.</p>
<p>7 Bitumen shingles</p> <p>Diagram showing the application of bitumen shingles S8 to the roof edge.</p>	<p>8</p> <p>Diagram showing the application of bitumen shingles S7 and S8 to the roof edge using a hammer A18.</p>	<p>8 Bitumen shingles</p> <p>Diagram showing the application of bitumen shingles S7 and S8 to the roof edge using a hammer A18.</p>

12. Sauna Cube 3 x 2 with changing room

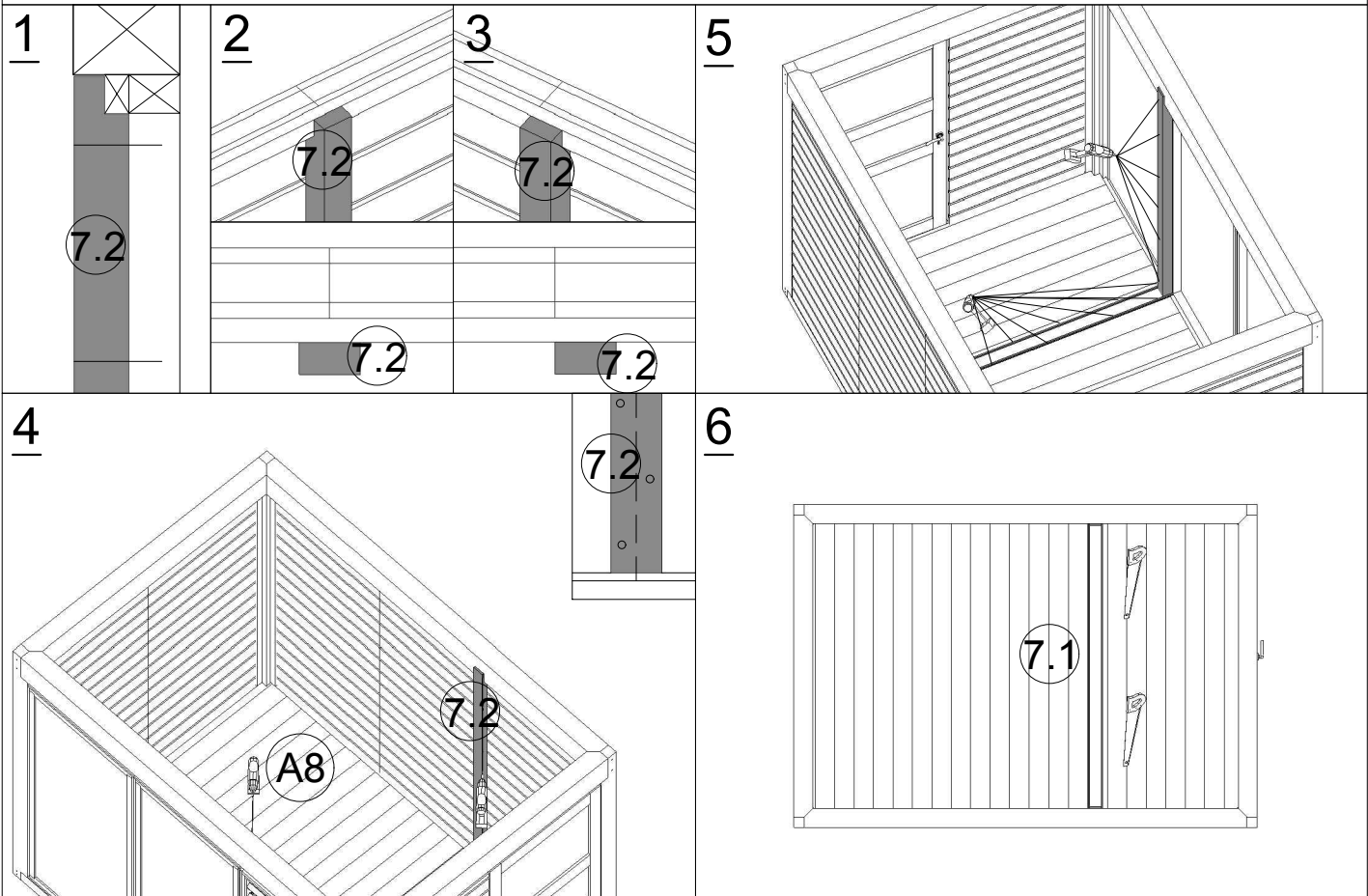
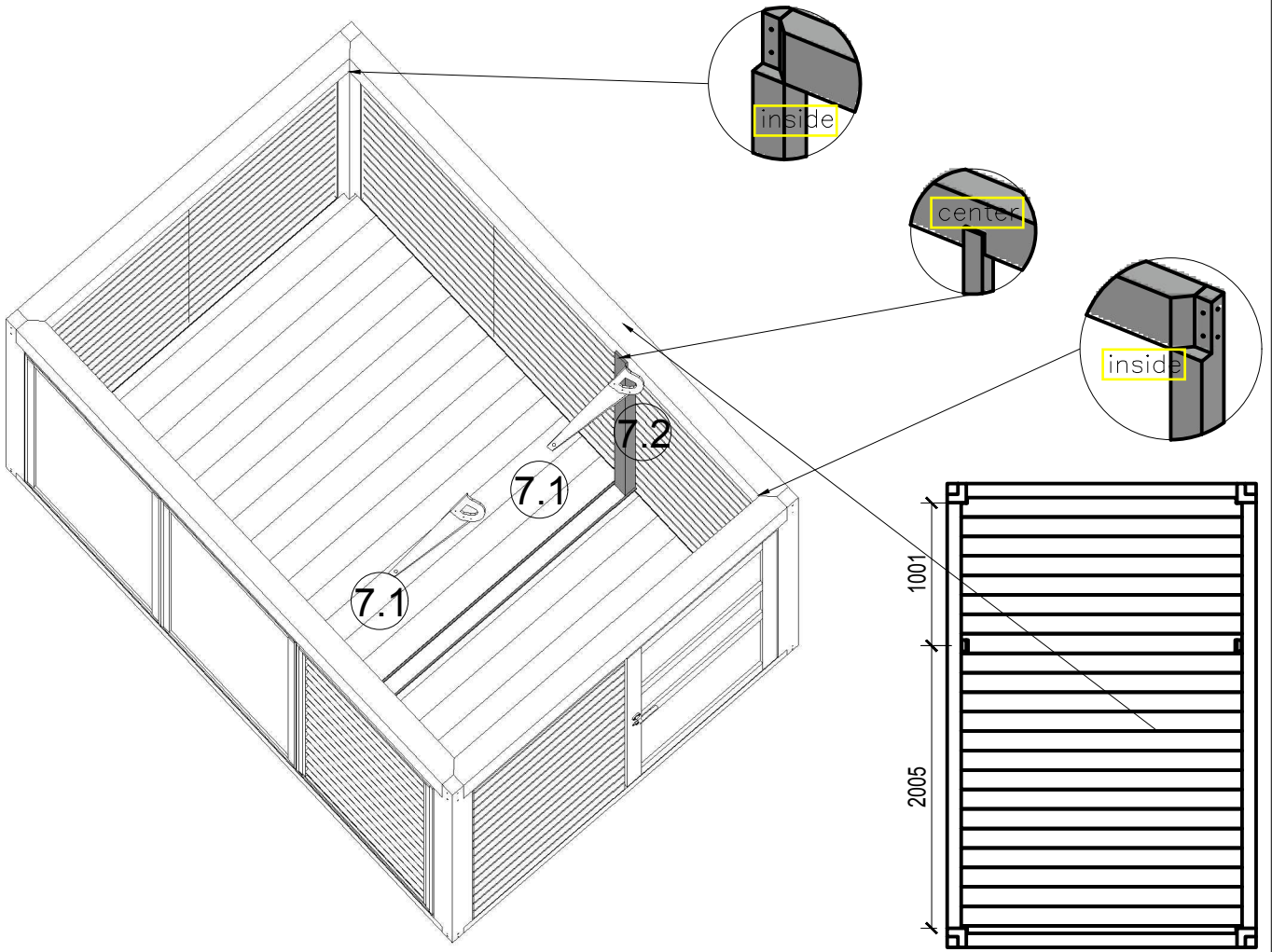

13. Sauna cube 3 x 2 with changing room

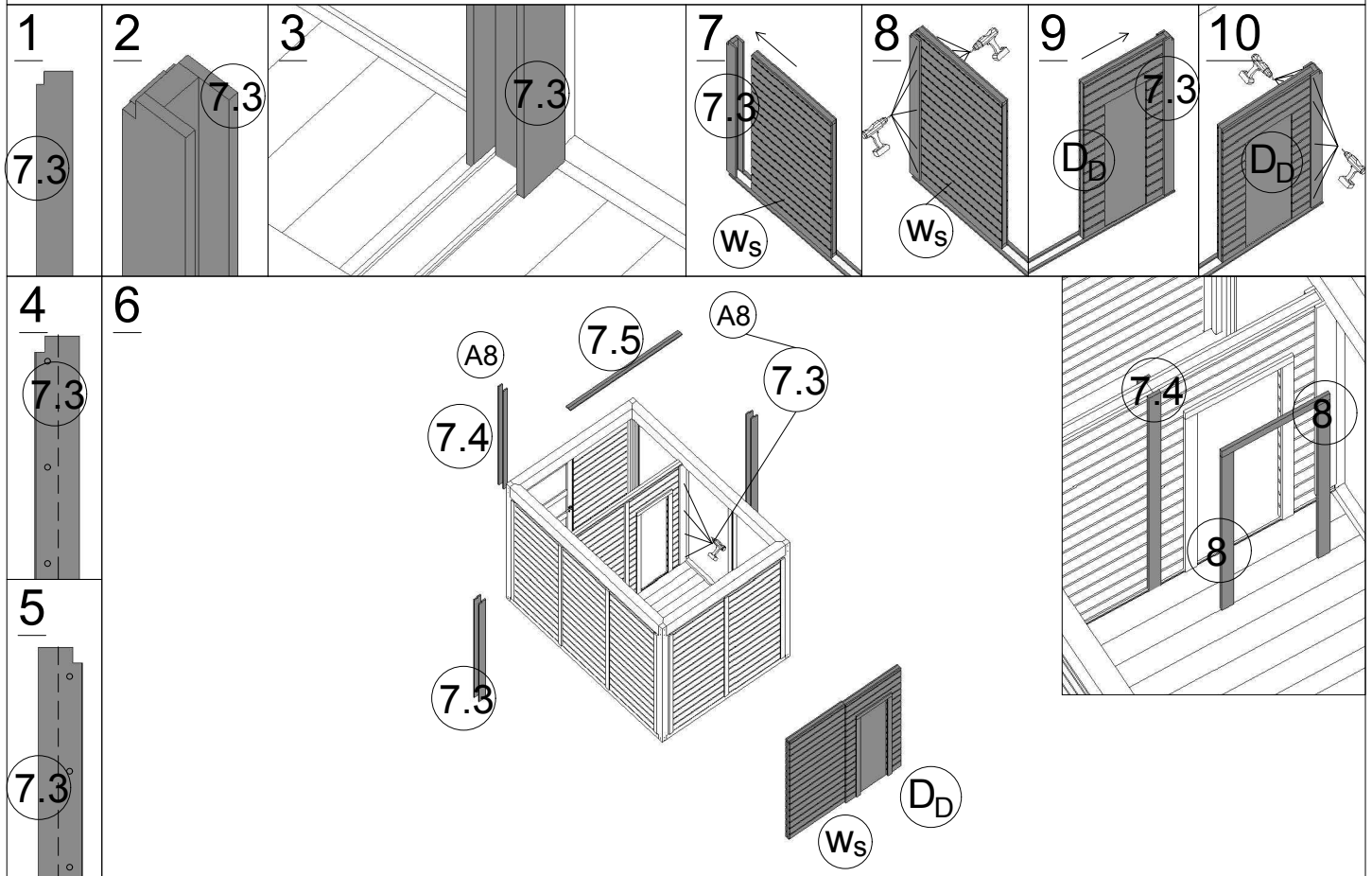
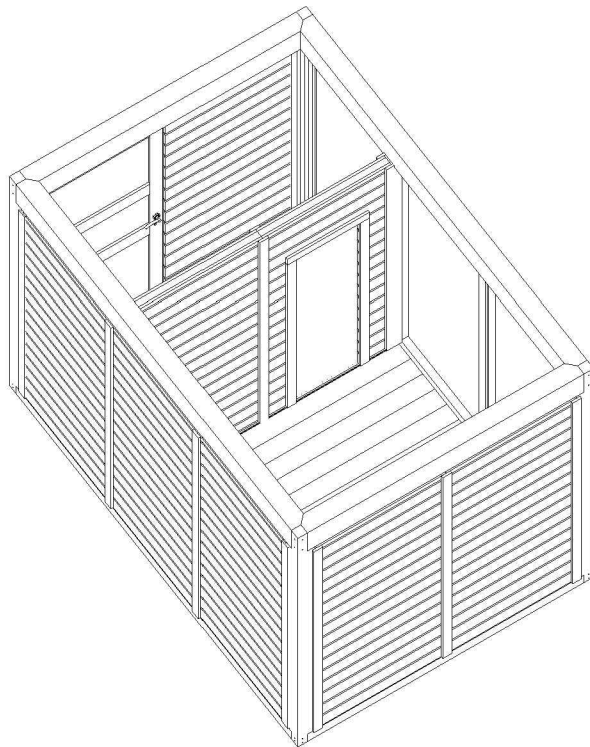

14. Sauna Cube 3 x 2 with changing room

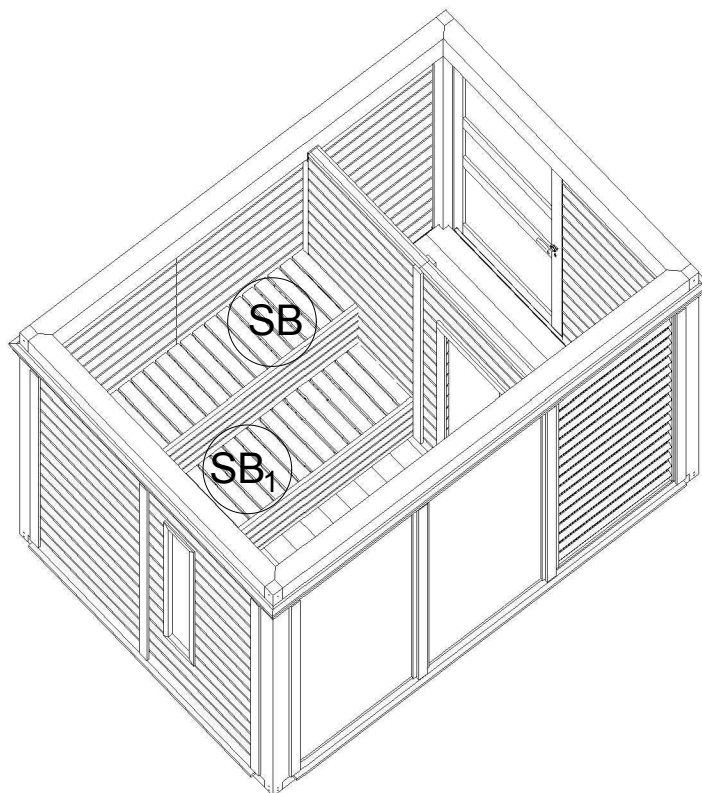

1

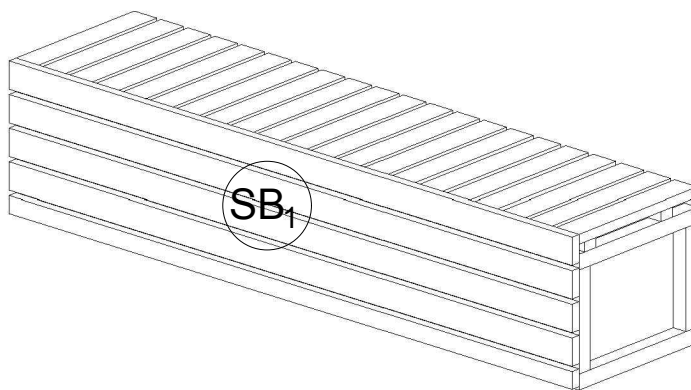

2

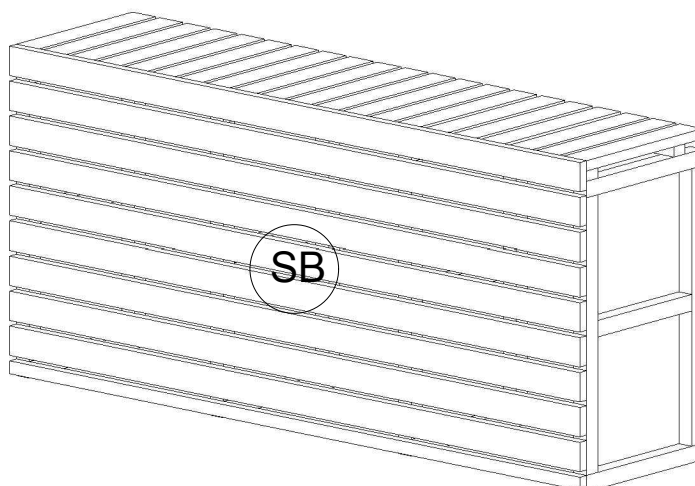

15. Sauna cube 3 x 2 with changing room

