

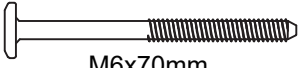







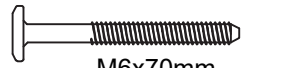

# HARDWARE

A	 15mm	 M6x70mm	08	E	 15mm	 M6x70mm	08
B			08	F			01
C		 Ø8x30mm	104	G	 8mm	 Ø4x30mm	56
D	 15mm	 Ø6x80mm	08	H	 15mm	 Ø6x70mm	05

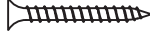

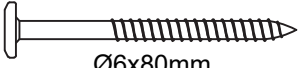

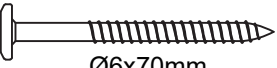
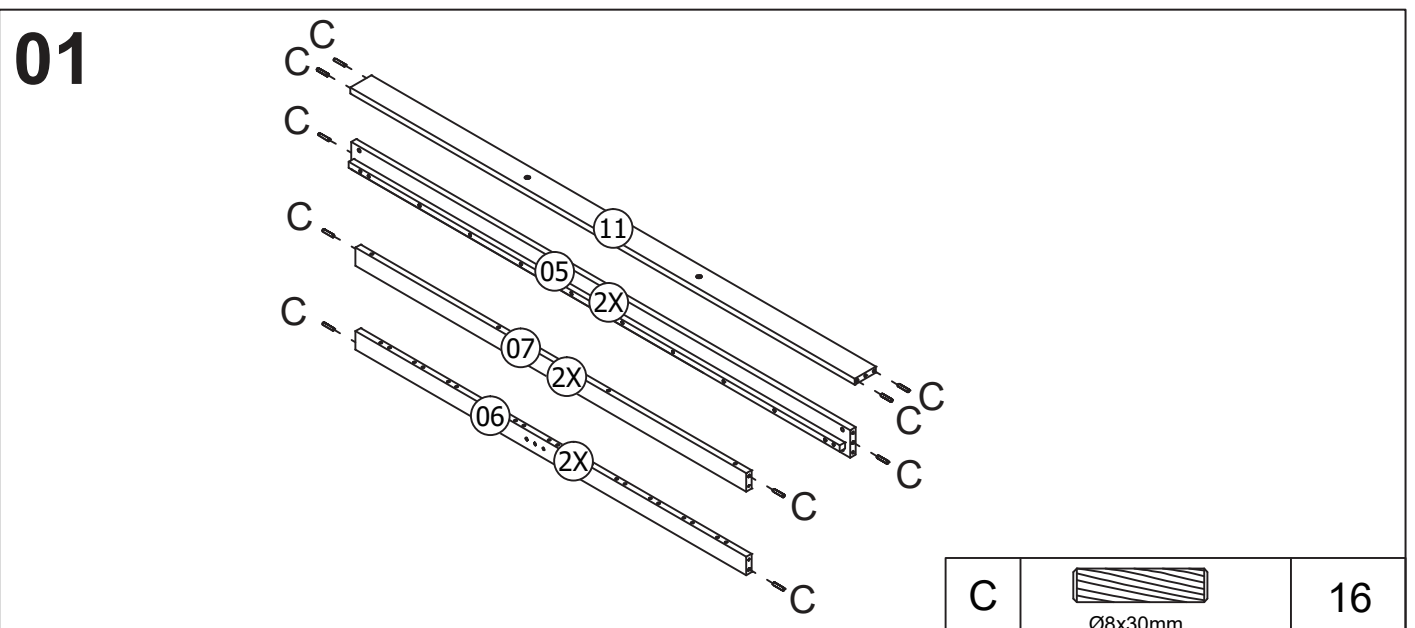
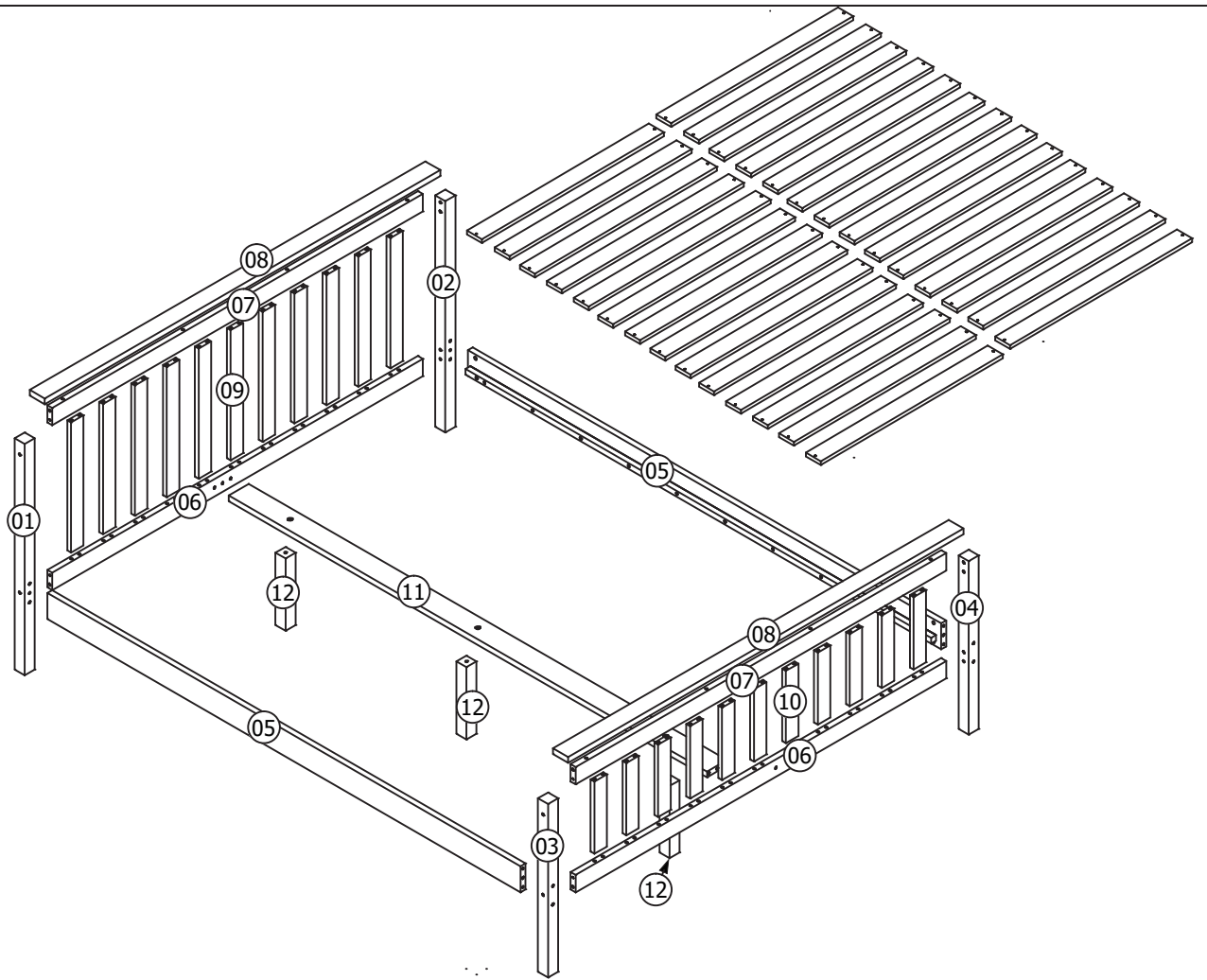

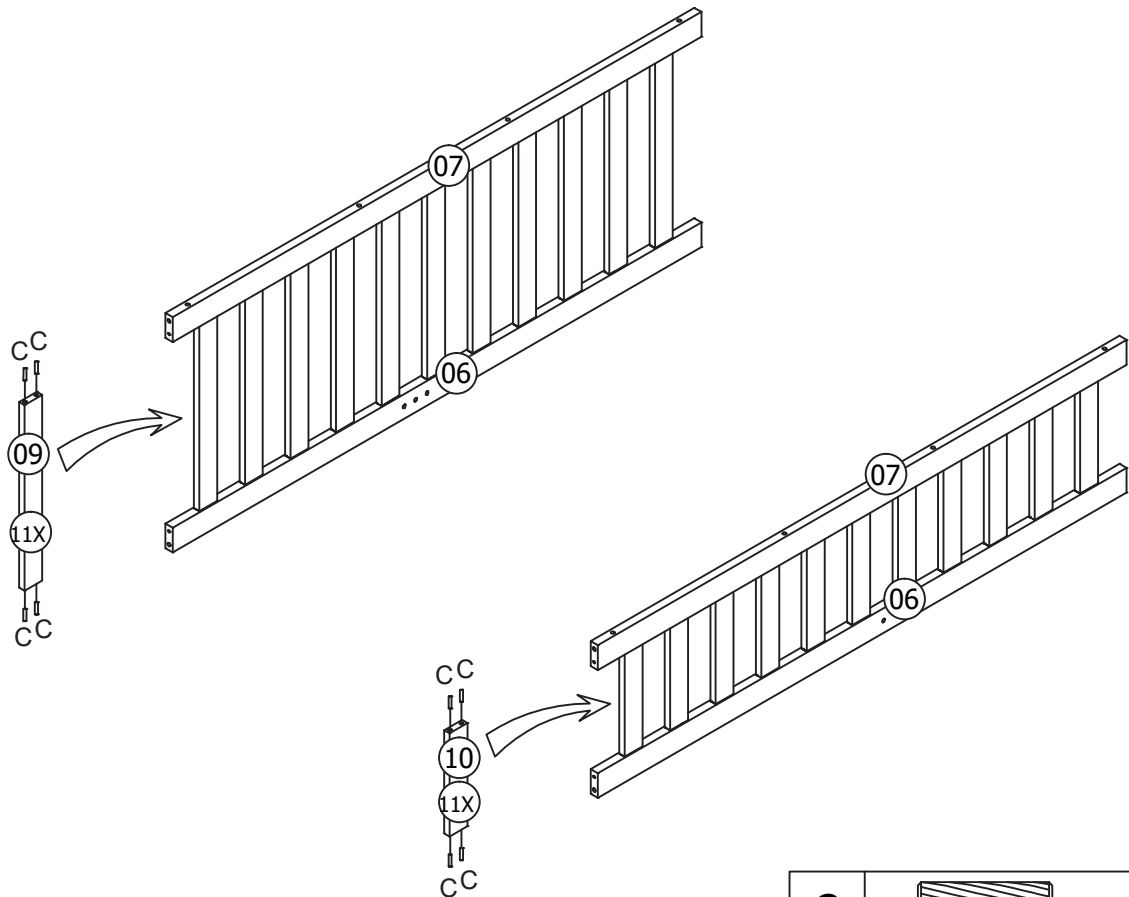
# 02

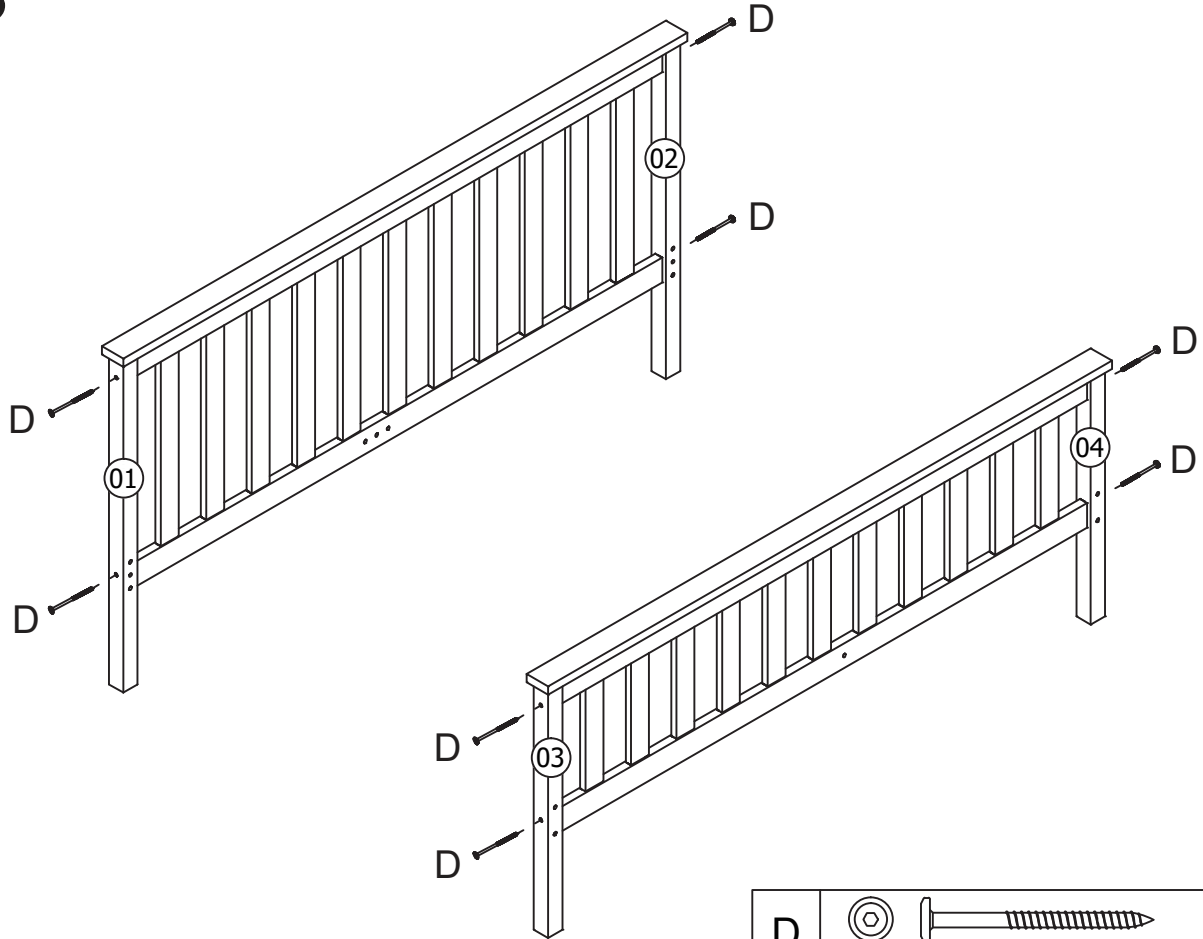

C	 Ø8x30mm	88
---	--	----

# 03

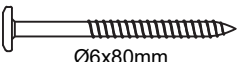

D			Ø6x80mm	08
---	---	---	---------	----

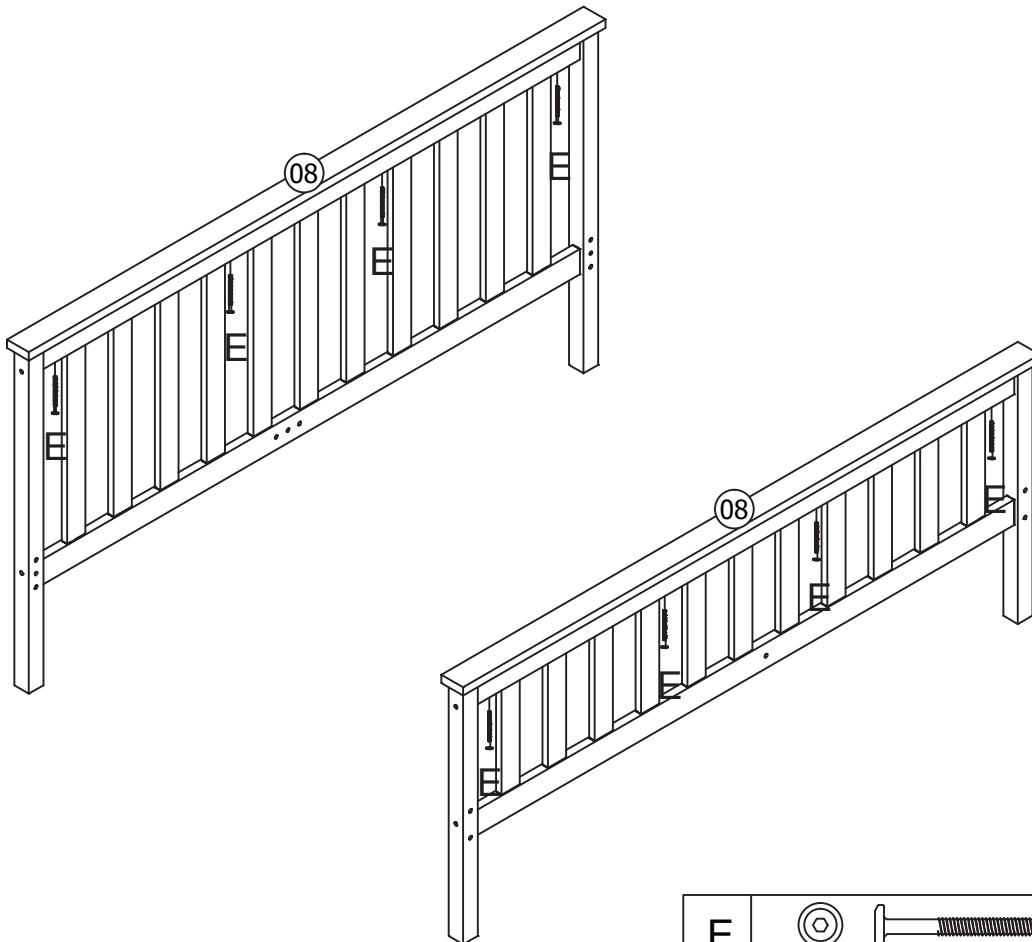

# 04

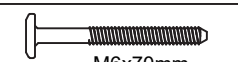

E			M6x70mm	08
---	---	---	---------	----

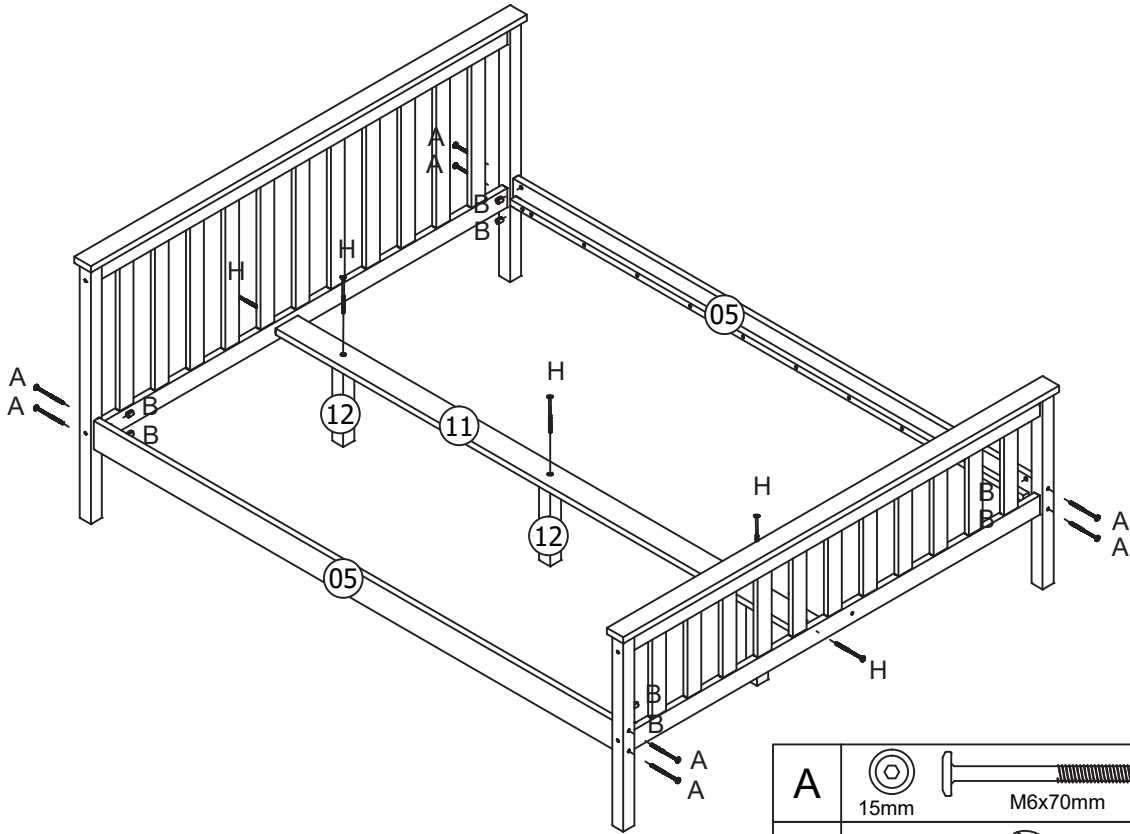
# 05

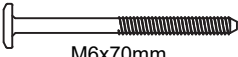

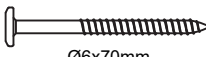
A	 	08
B		08
H	 	05

# 06

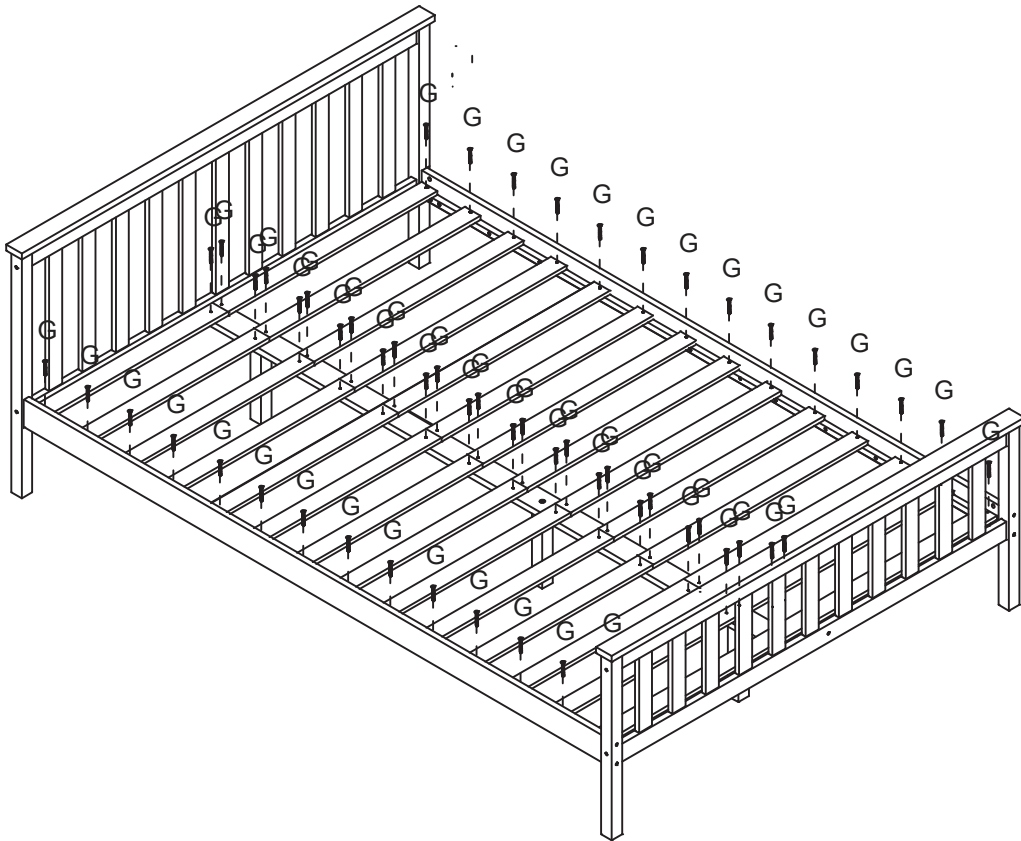

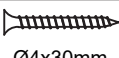
G	 	56
---	---	----