

Sabine

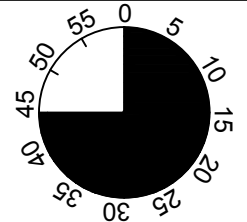

1

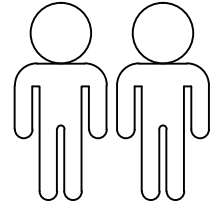
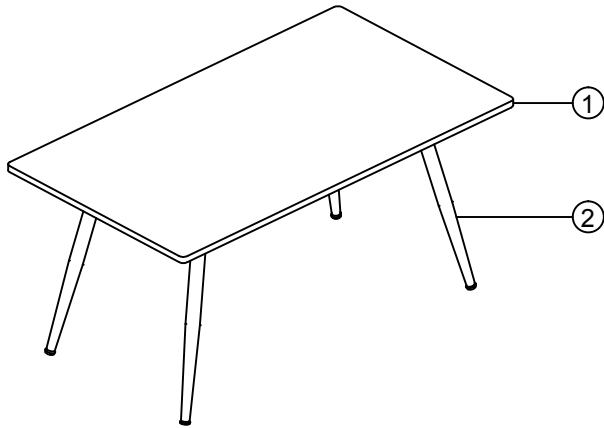
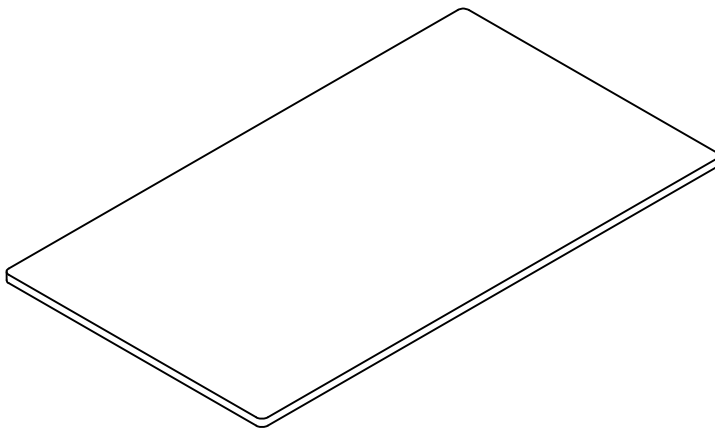

2



3

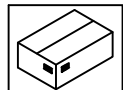
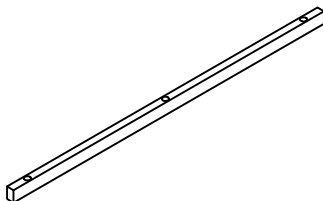





1	1X	1/2
2	4X	2/2
3	2X	2/2

A	M6X40	B	M8x20	C	Ø18xØ8x1.5	D	Ø18xØ6x2.5	E	M8x18	F	M6x18
	6x		12x		12x		2x		12x		6x
G	5MM	H	6MM	I	8MM						
	1x		1x		1x						

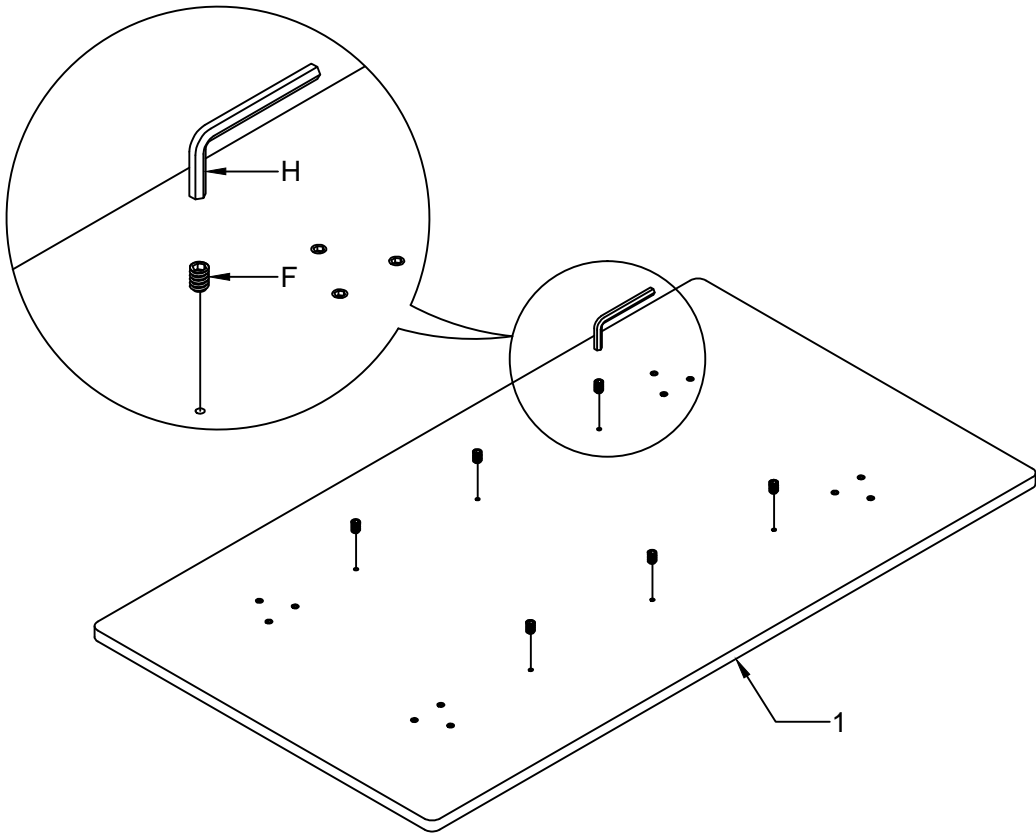
I.



1

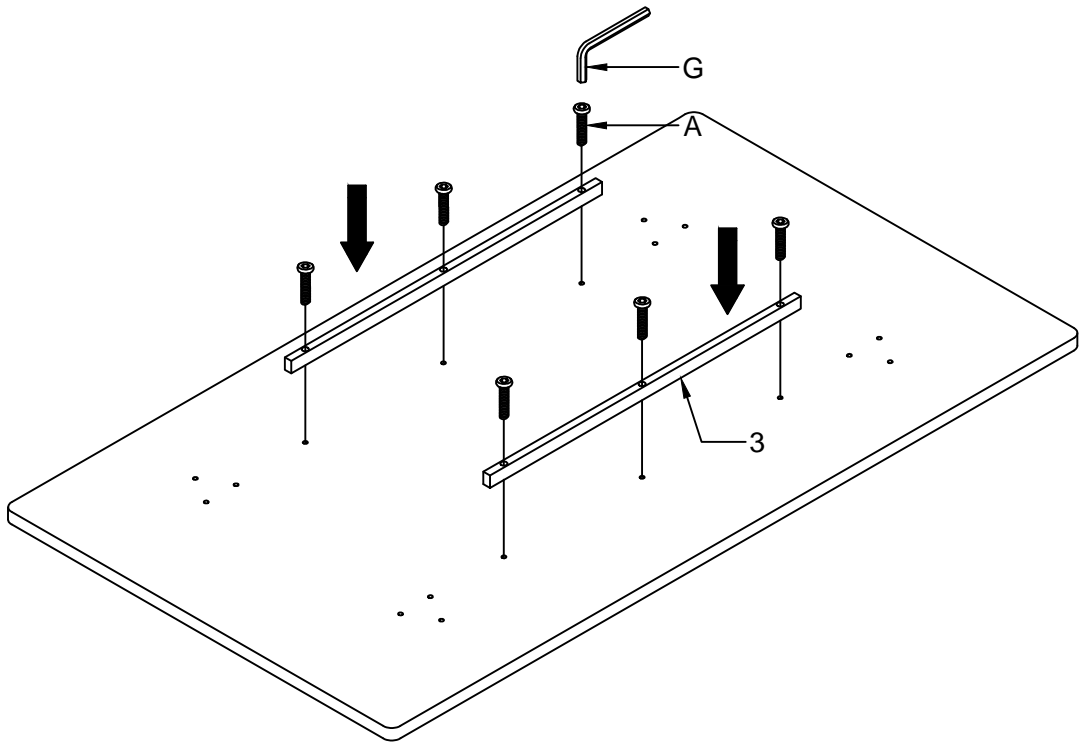

F	M6x18
	6x
H	6MM
	1x
	

2

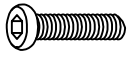



A	M6x40
	6x
G	5MM
	1x
	

II.

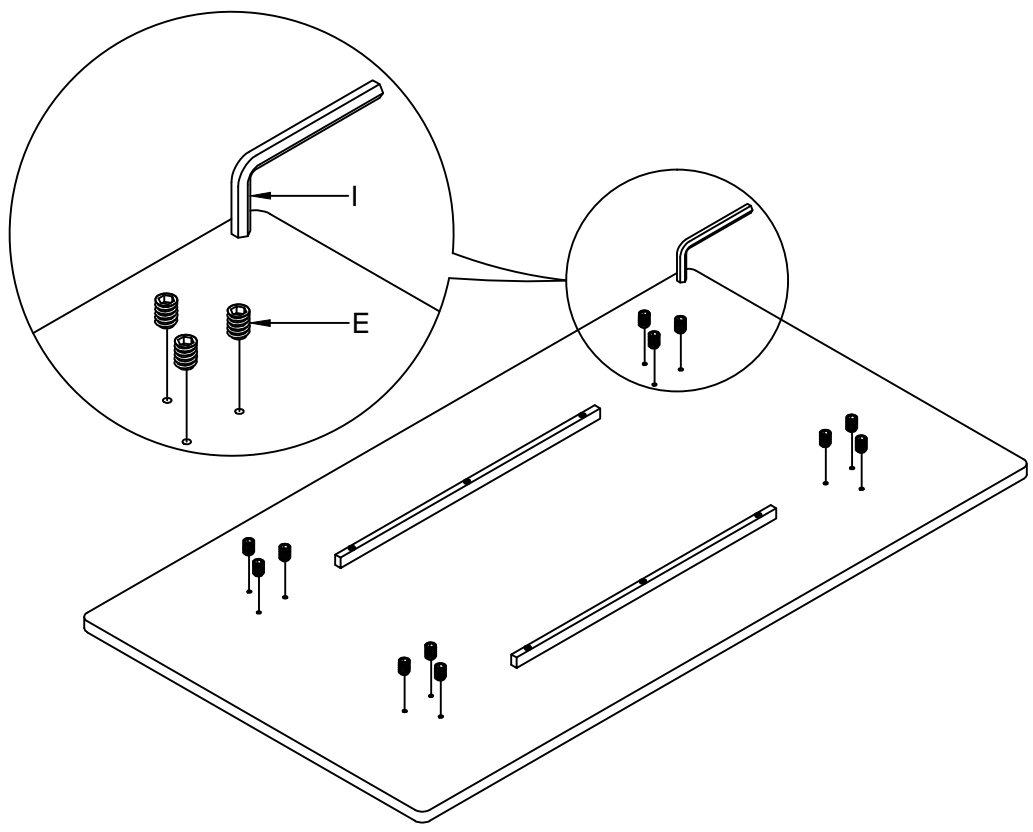

3

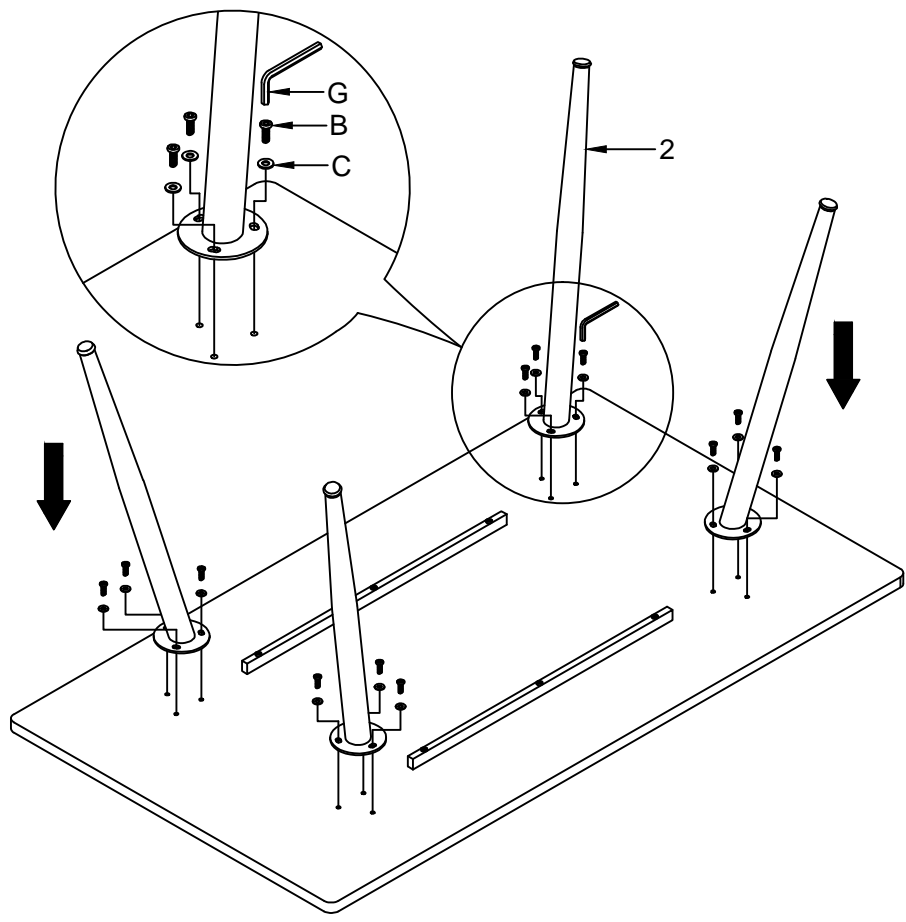

E	M8x18
	12x
I	8MM
	1x
	

4

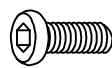

B	M8x20
	12x
C	Ø18xØ8x1.5
	12x
G	5MM
	1x
