

1803

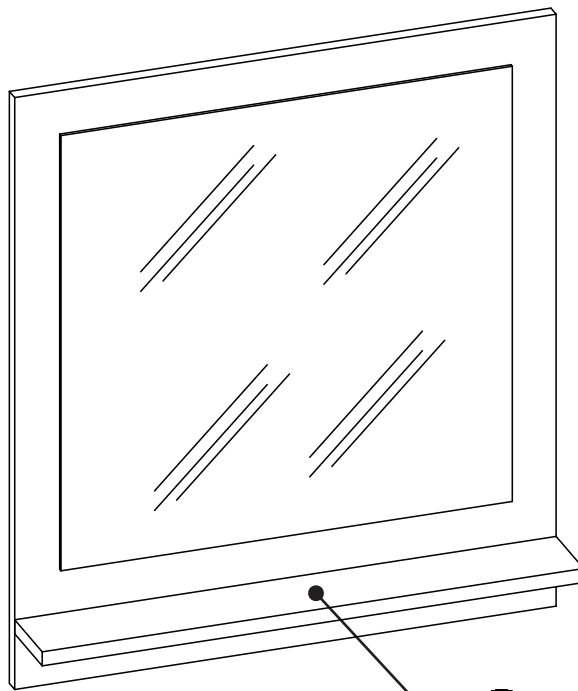

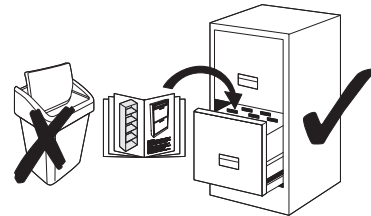



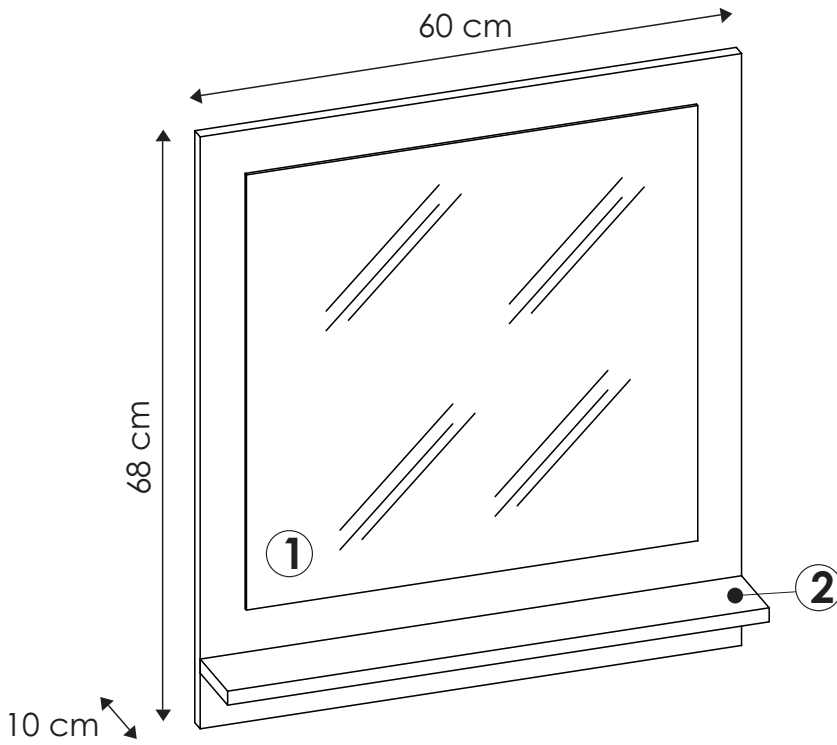

# ATTACK ATL01

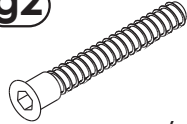

 max.  
1 kg

# ATTACK ATL01



<p><b>a1</b></p>  <p>8x35 X... (x4)</p>	<p><b>c2</b></p>  <p>Euro 5x13 X... (x4)</p>	<p><b>c4</b></p>  <p>Euro 6,3x13 X... (x2)</p>	<p><b>g0</b></p>  <p>X... (x3)</p>	<p><b>g2</b></p>  <p>7x60 X... (x3)</p>	<p><b>m</b></p>  <p>X... (x1)</p>	<p><b>p1</b></p>  <p>X... (x2)</p>	<p><b>r8</b></p>  <p>X... (x2)</p>
--	---	---	---	--	--	---	---

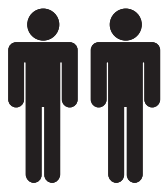

1

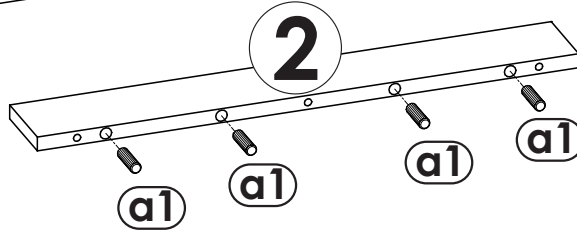
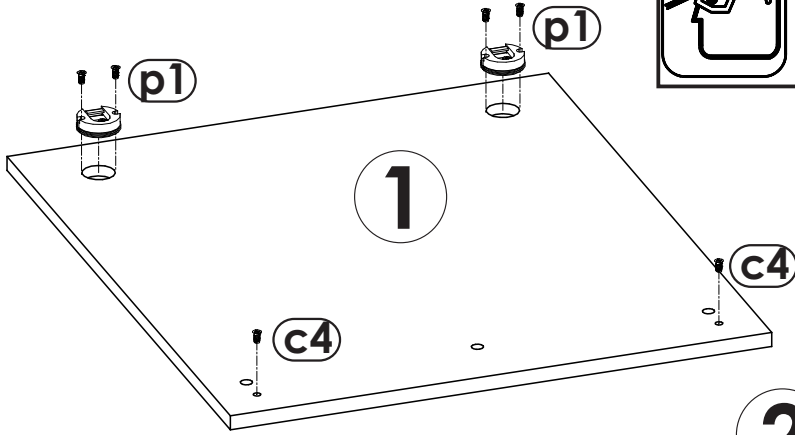
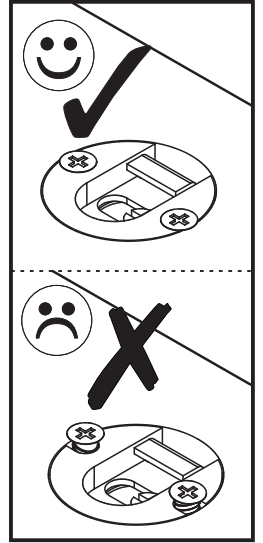
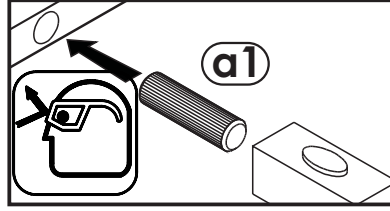
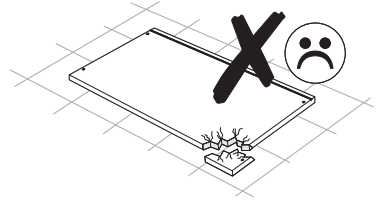
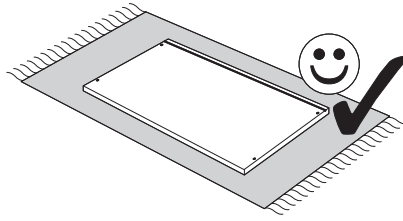
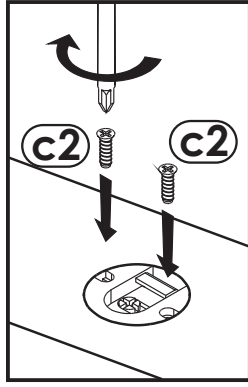
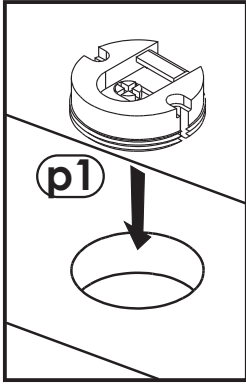

2

