

UNIT 2250/2346

01	1144x506x16	1/1
02	1144x322x16	1/1

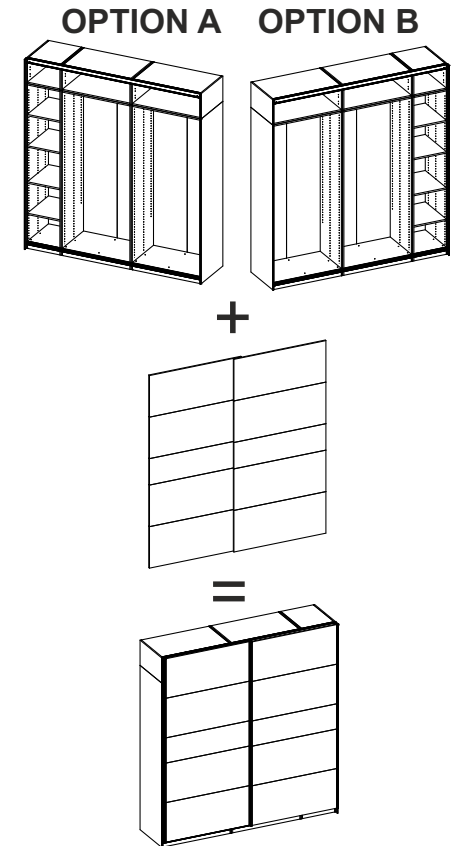
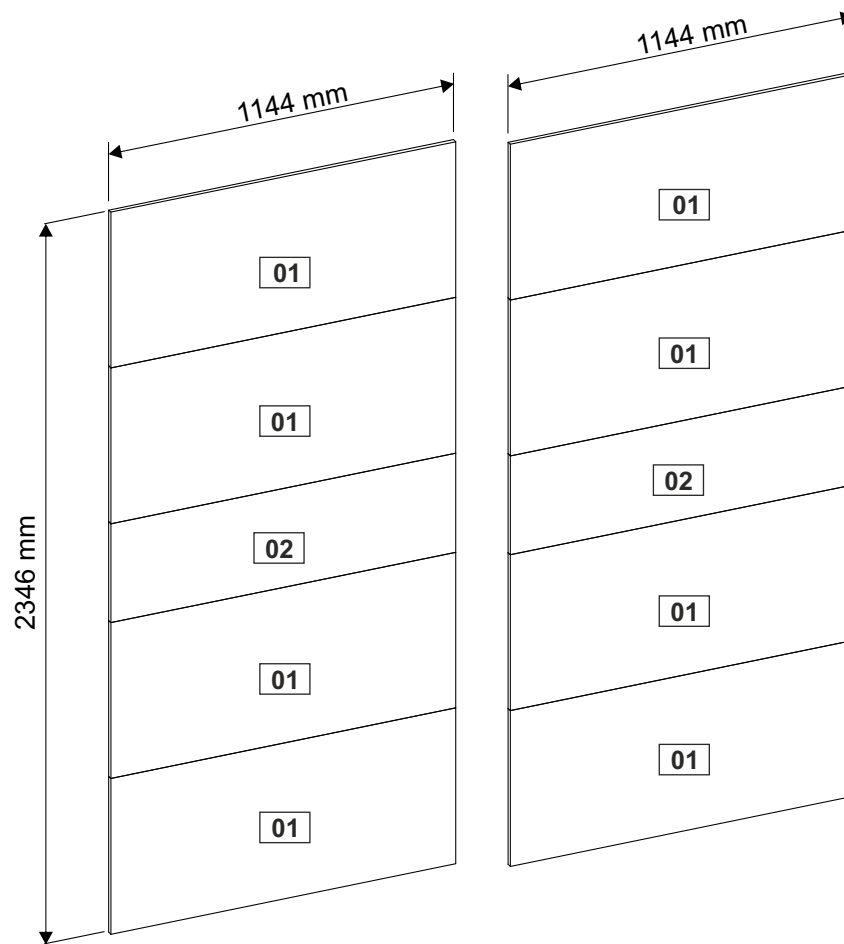
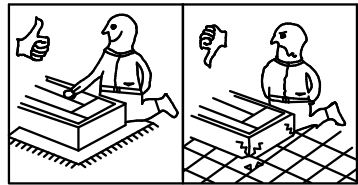
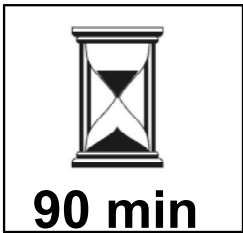
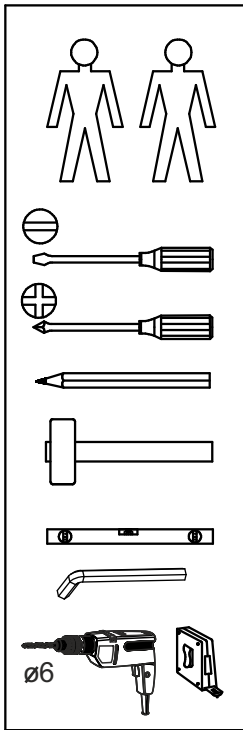

UNIT 2250/2346

C 1/1

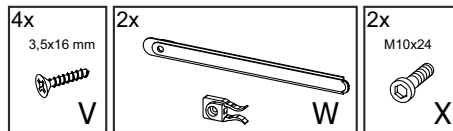
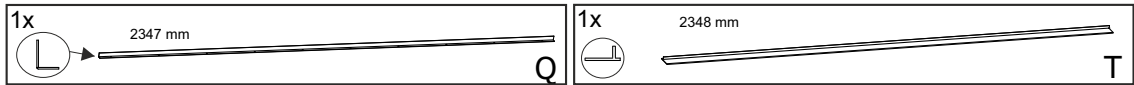
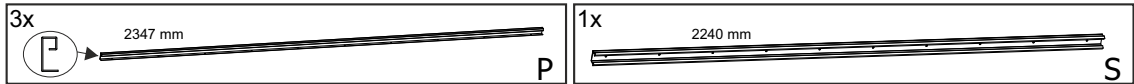
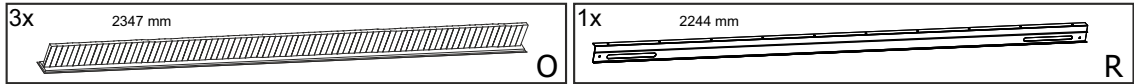
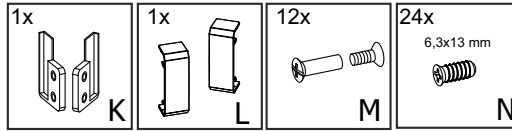
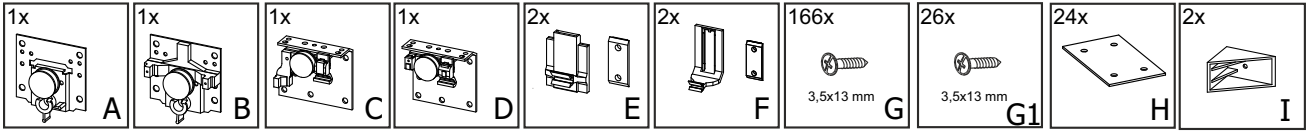
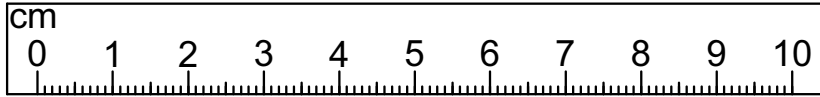

UNIT 2250/2346

1

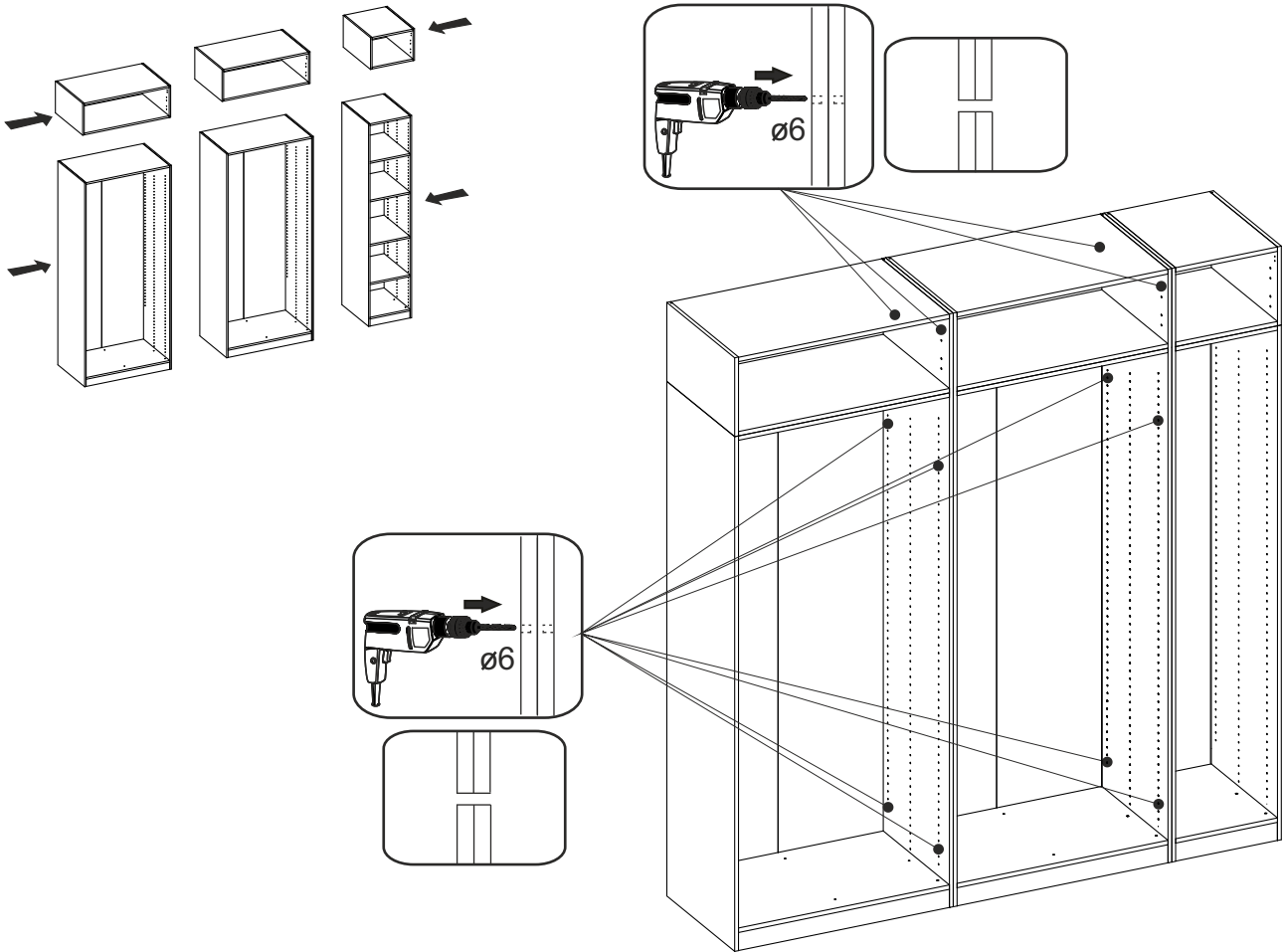

2

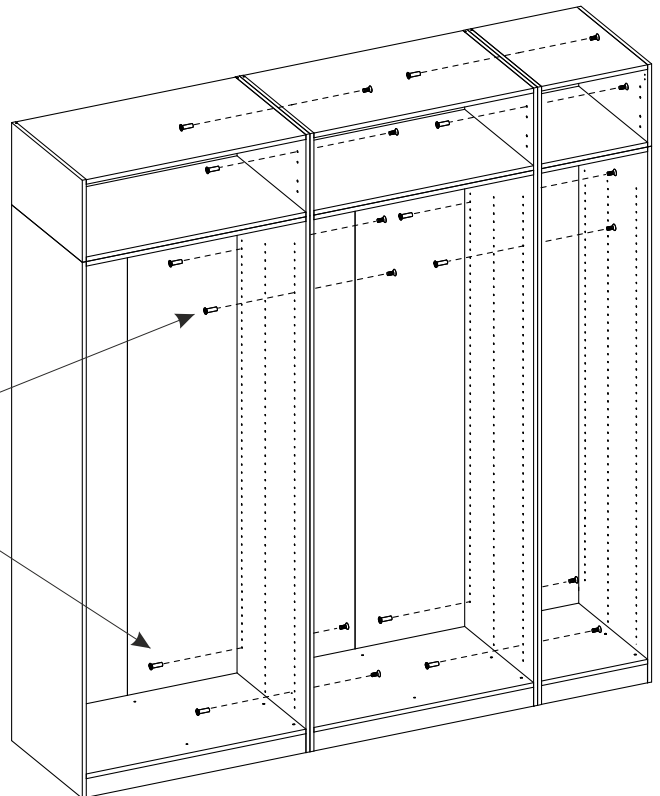
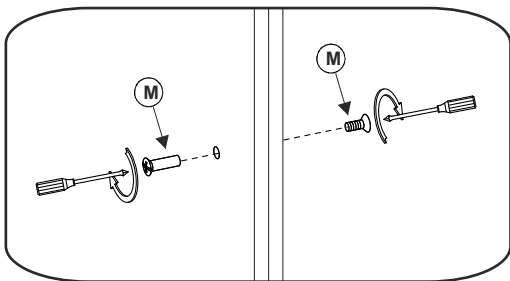
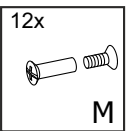

UNIT 2250/2346

3

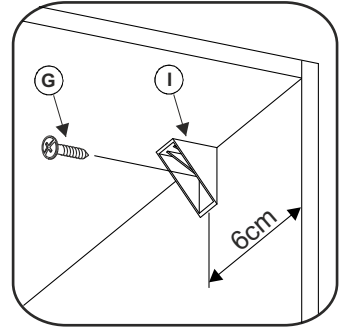
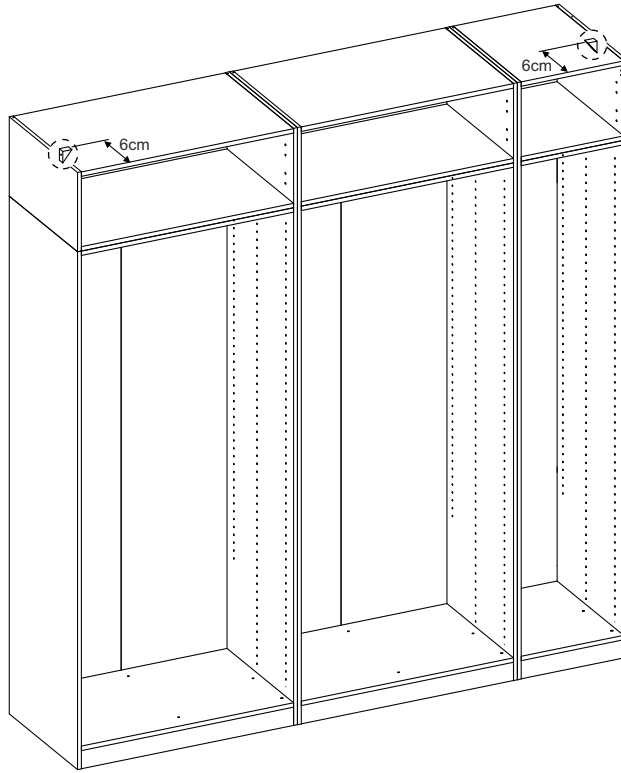
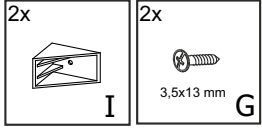

4

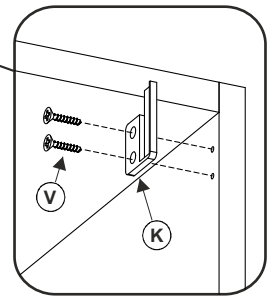
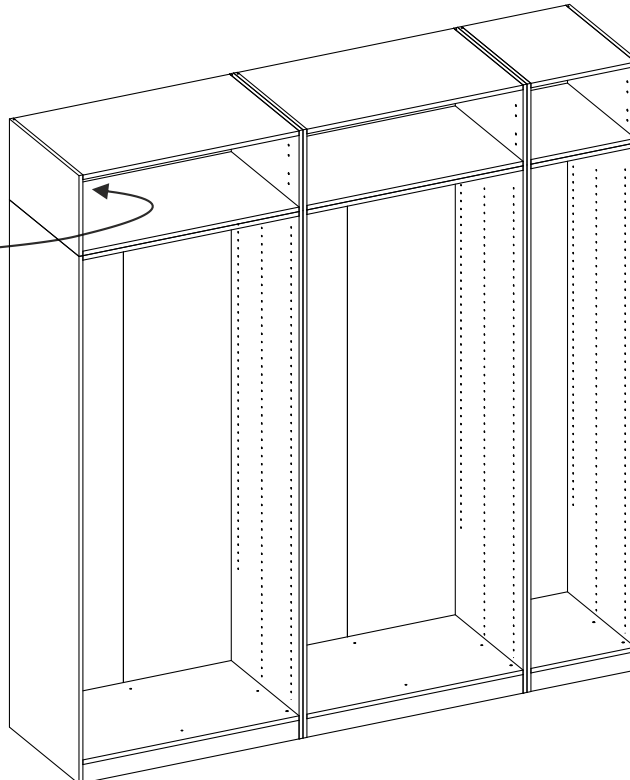
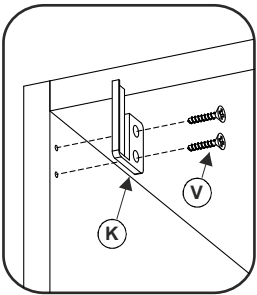
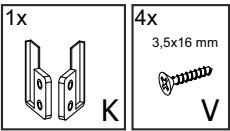

UNIT 2250/2346

5

10x
3,5x13 mm
G

1x 2244 mm
R

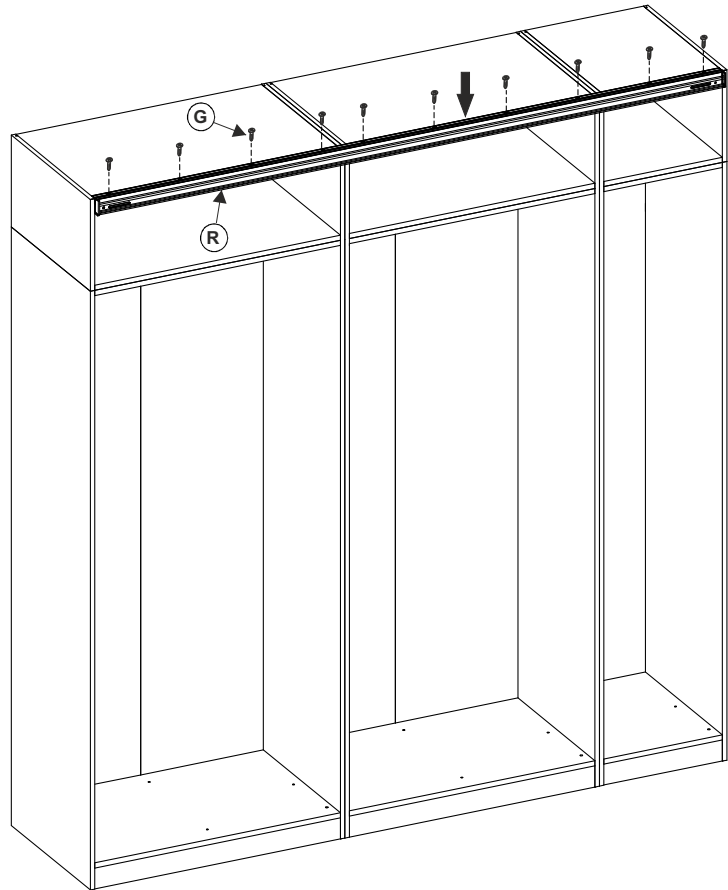
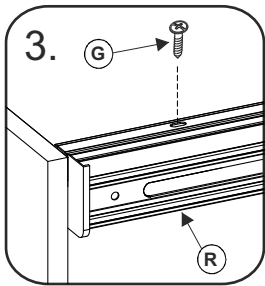
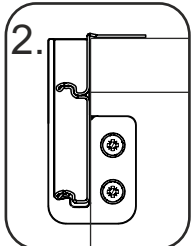
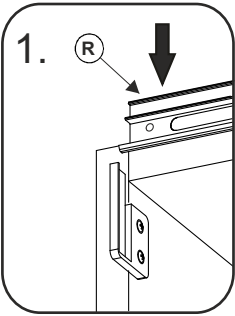

2x
W

2x
M10x24
X

6

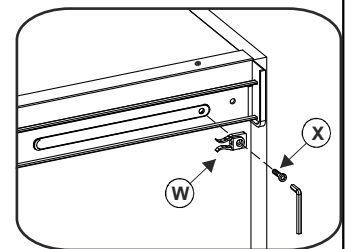
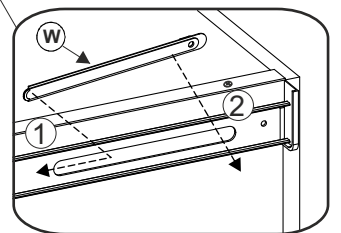
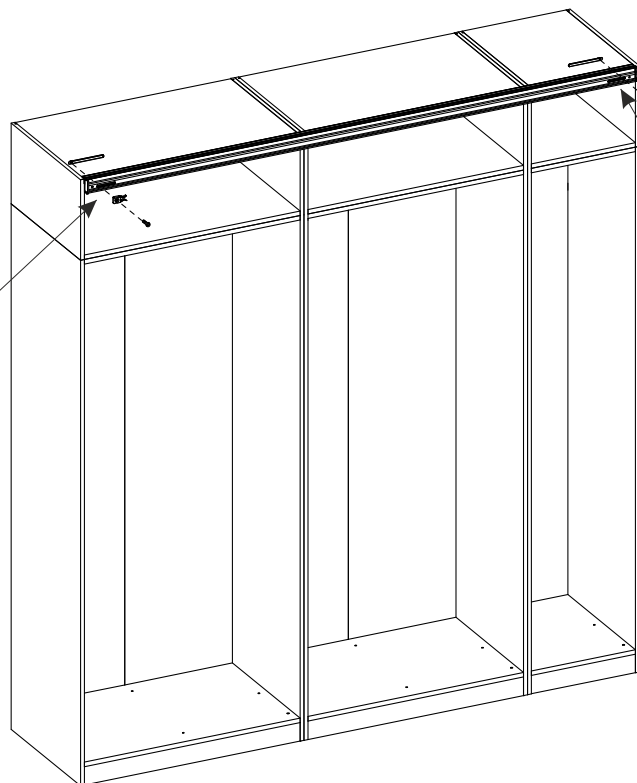
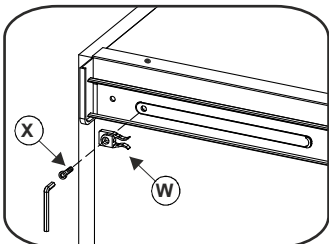
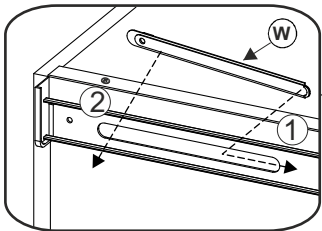

UNIT 2250/2346

7

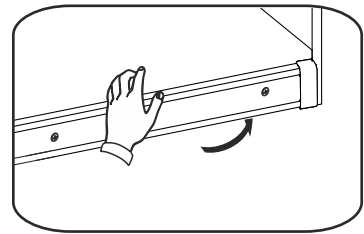
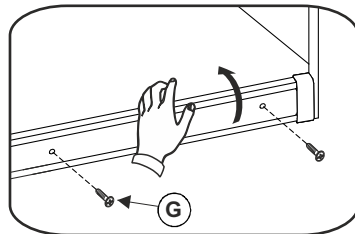
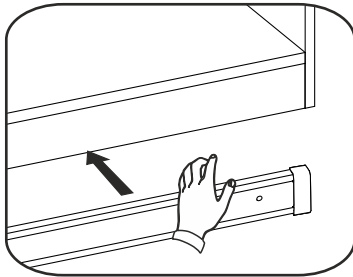
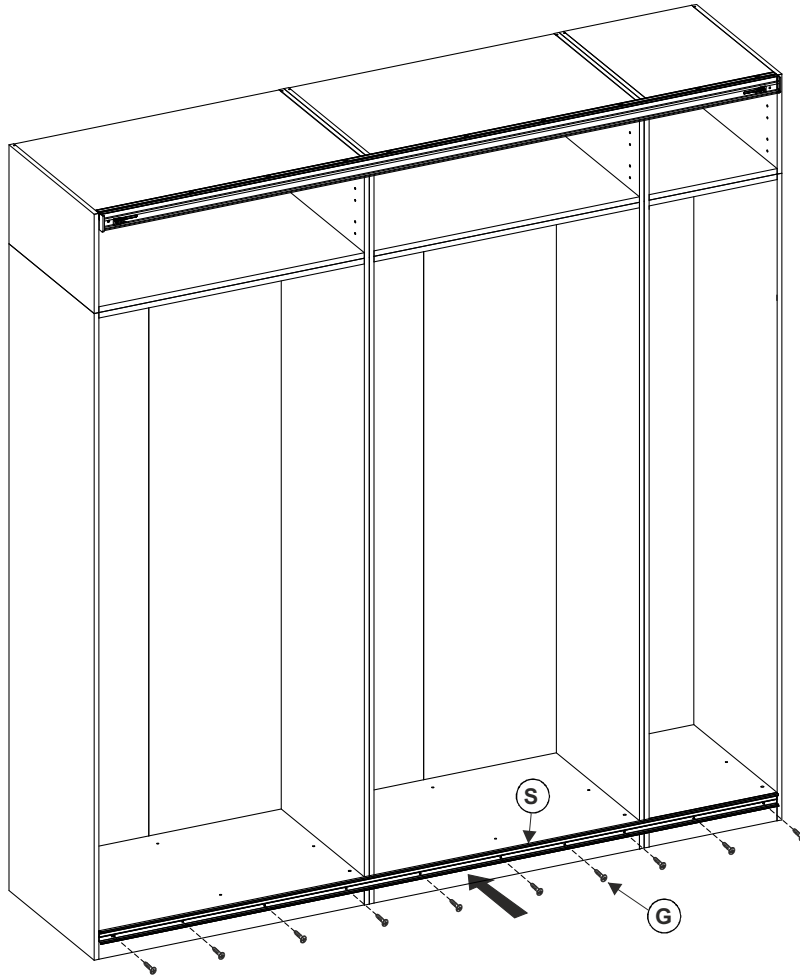
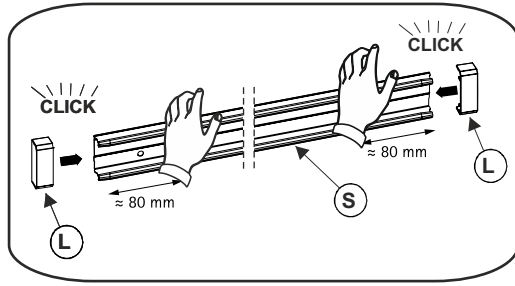
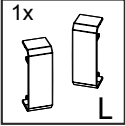
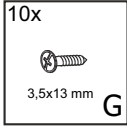

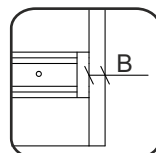
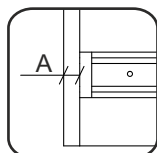

A=B

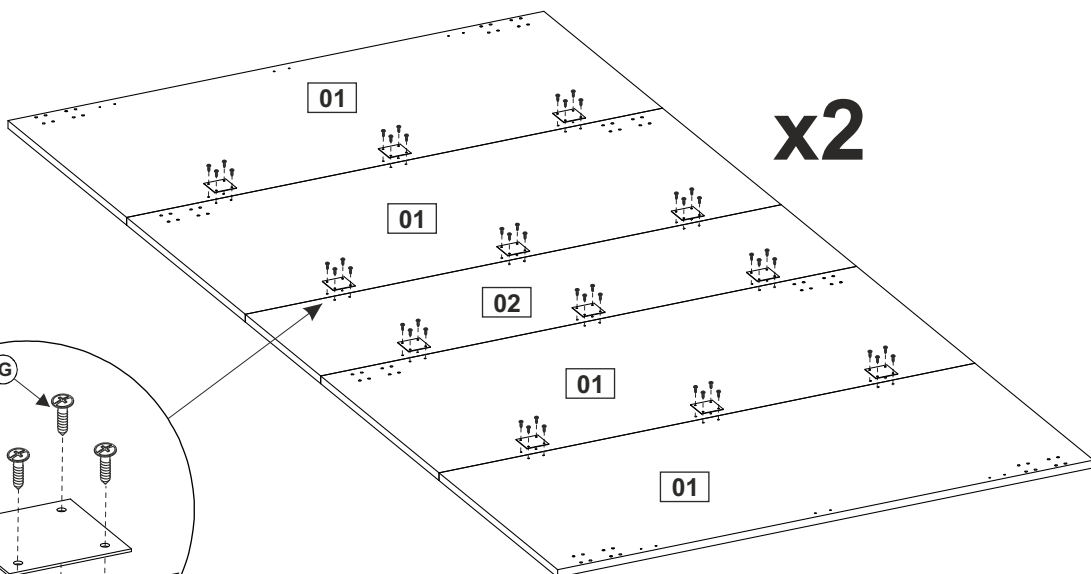
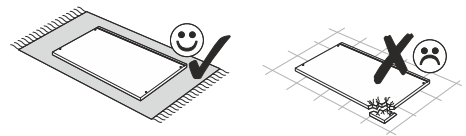
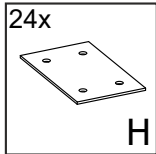
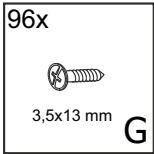
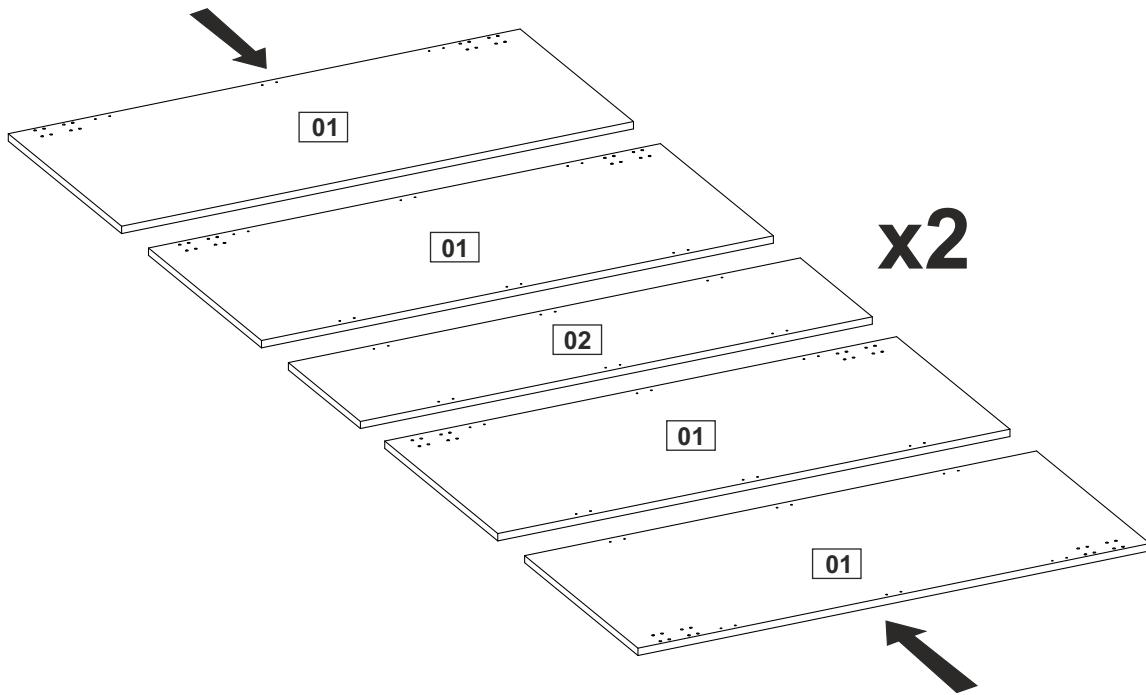
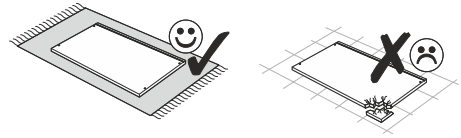



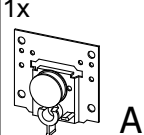
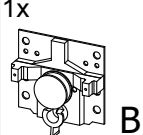
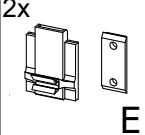

UNIT 2250/2346

10

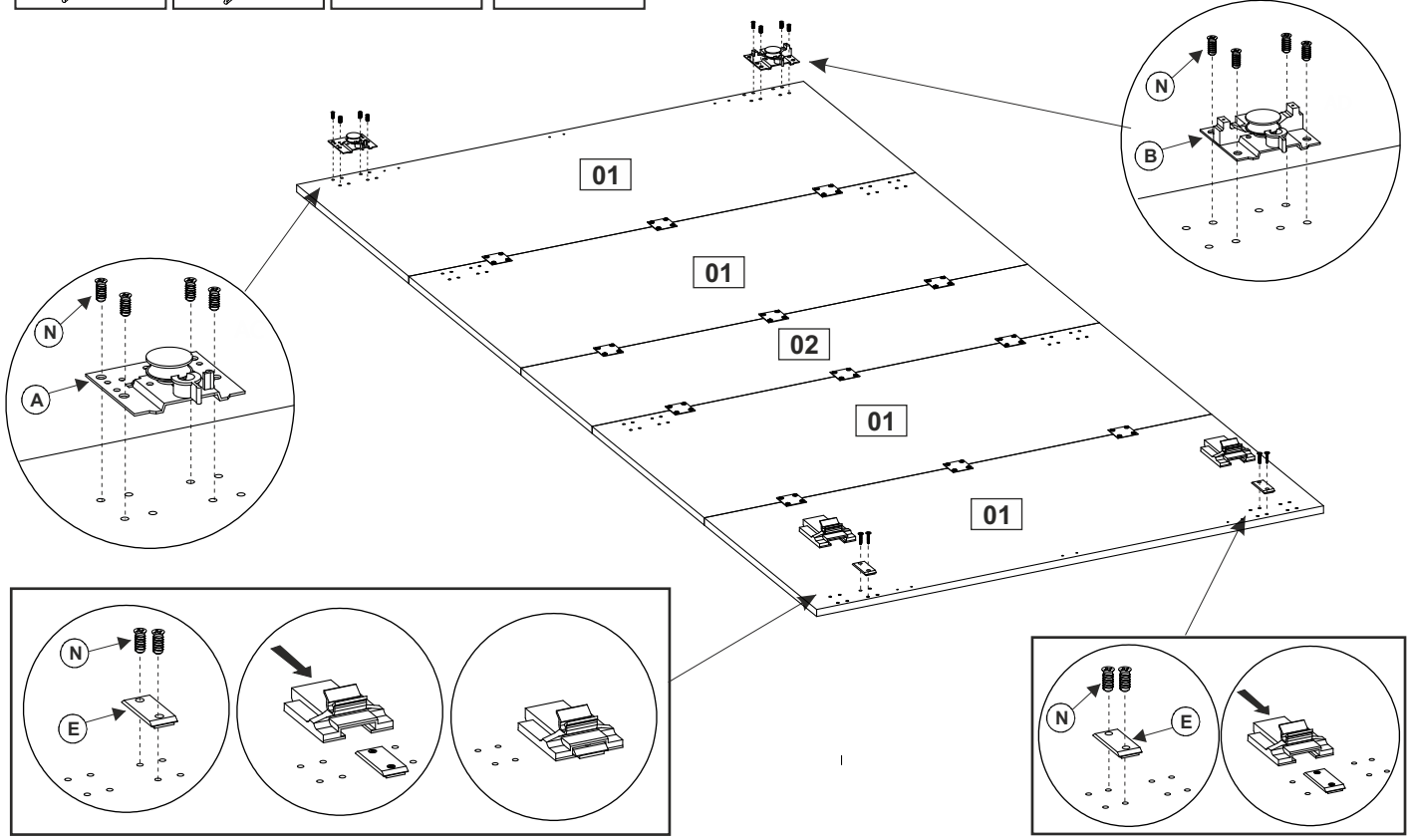
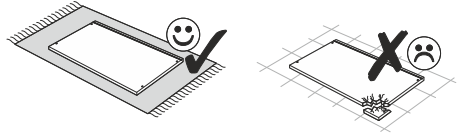
- 1x  A
- 1x  B
- 2x  E
- 12x  N
6,3x13 mm

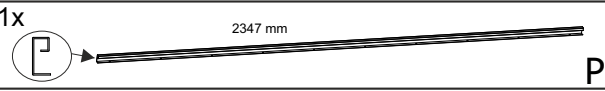
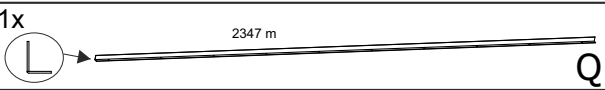

- 1x  P
2347 mm
- 1x  Q
2347 mm
- 24x  G
3,5x13 mm

11

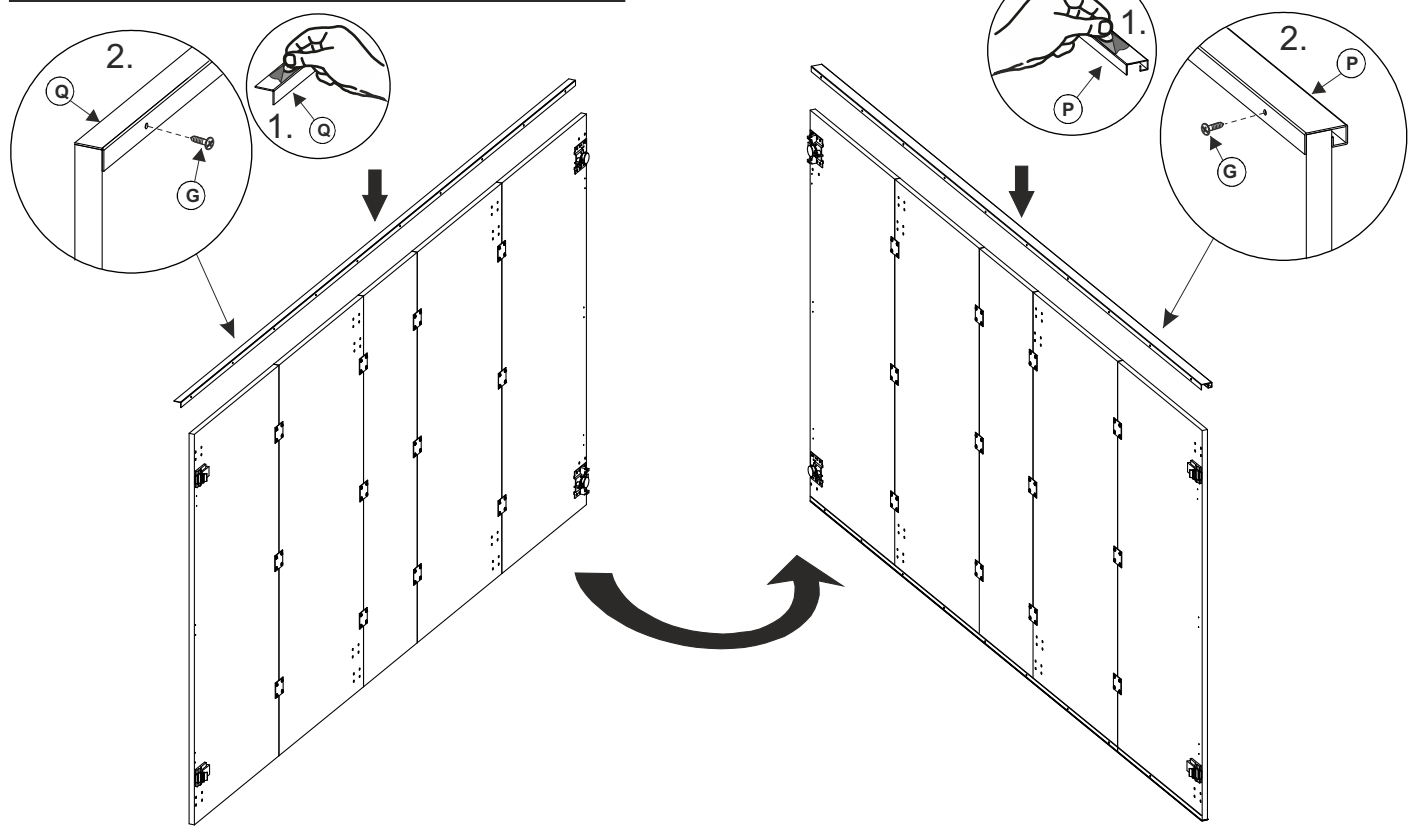

UNIT 2250/2346

1x 2347 mm 0

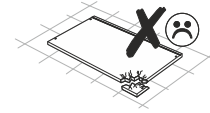
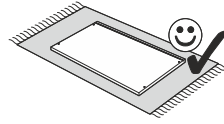

12

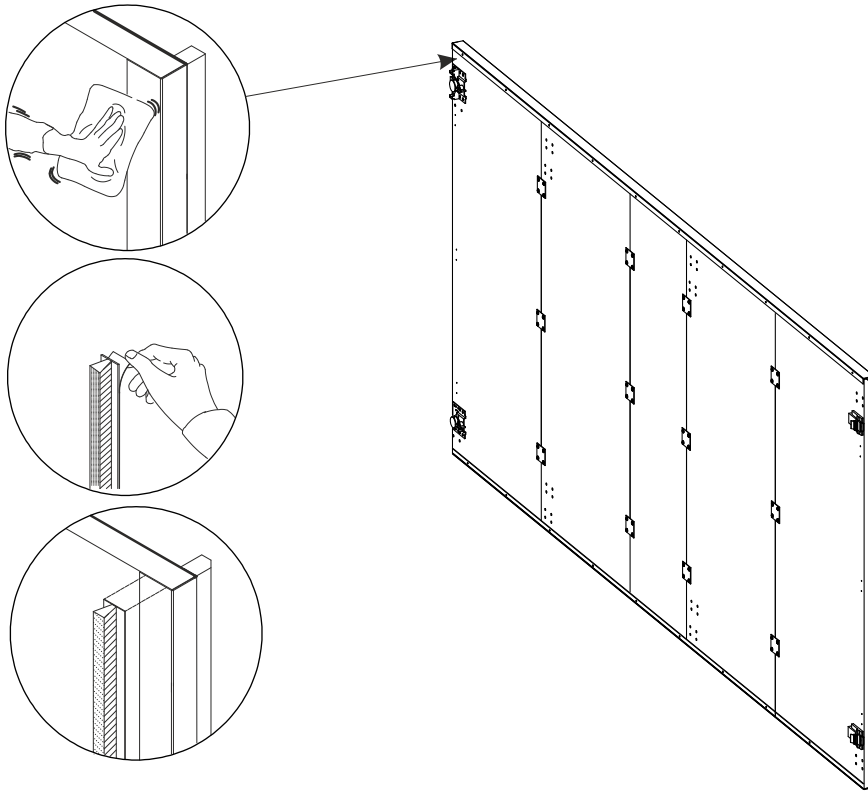

13

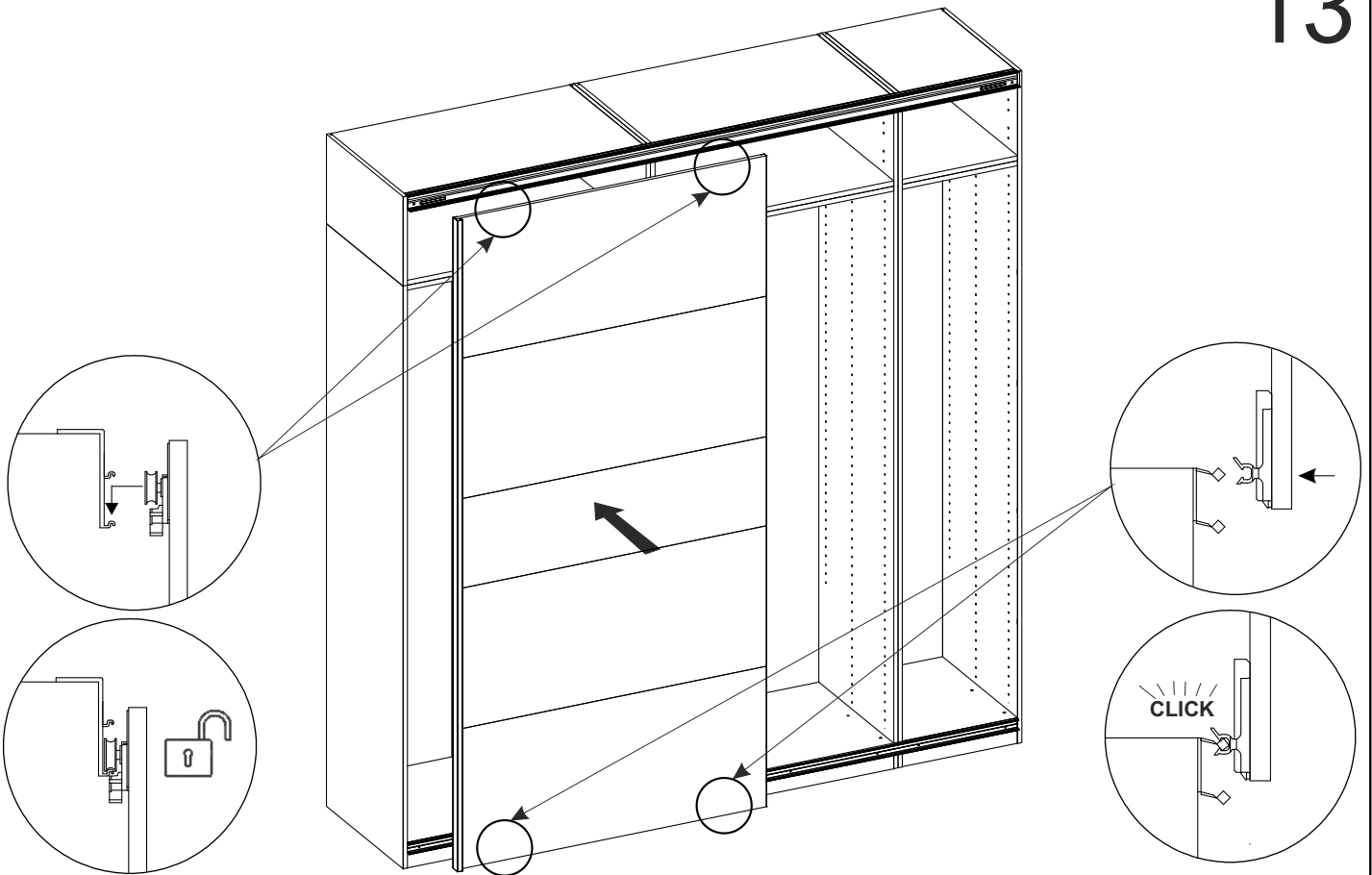

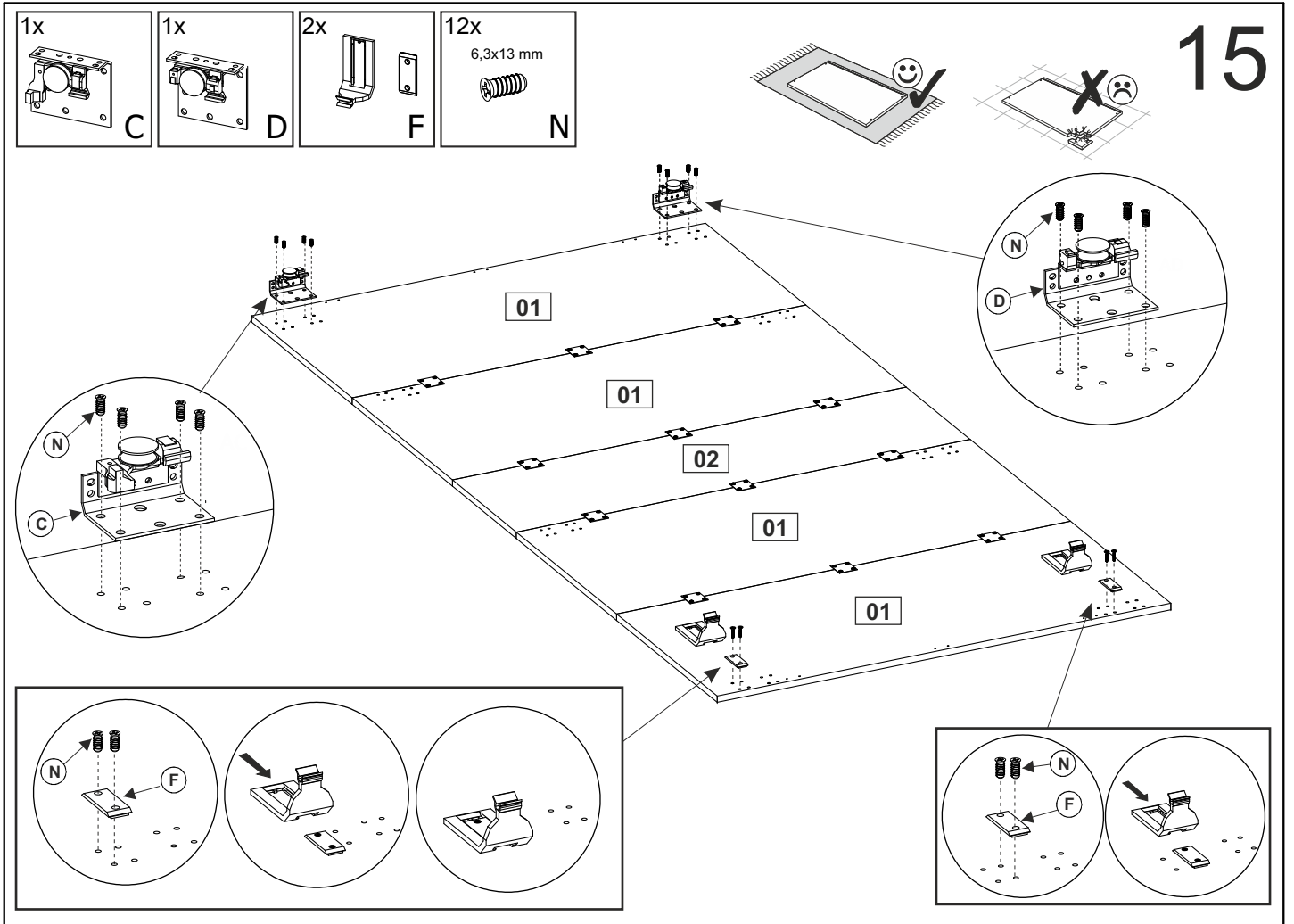
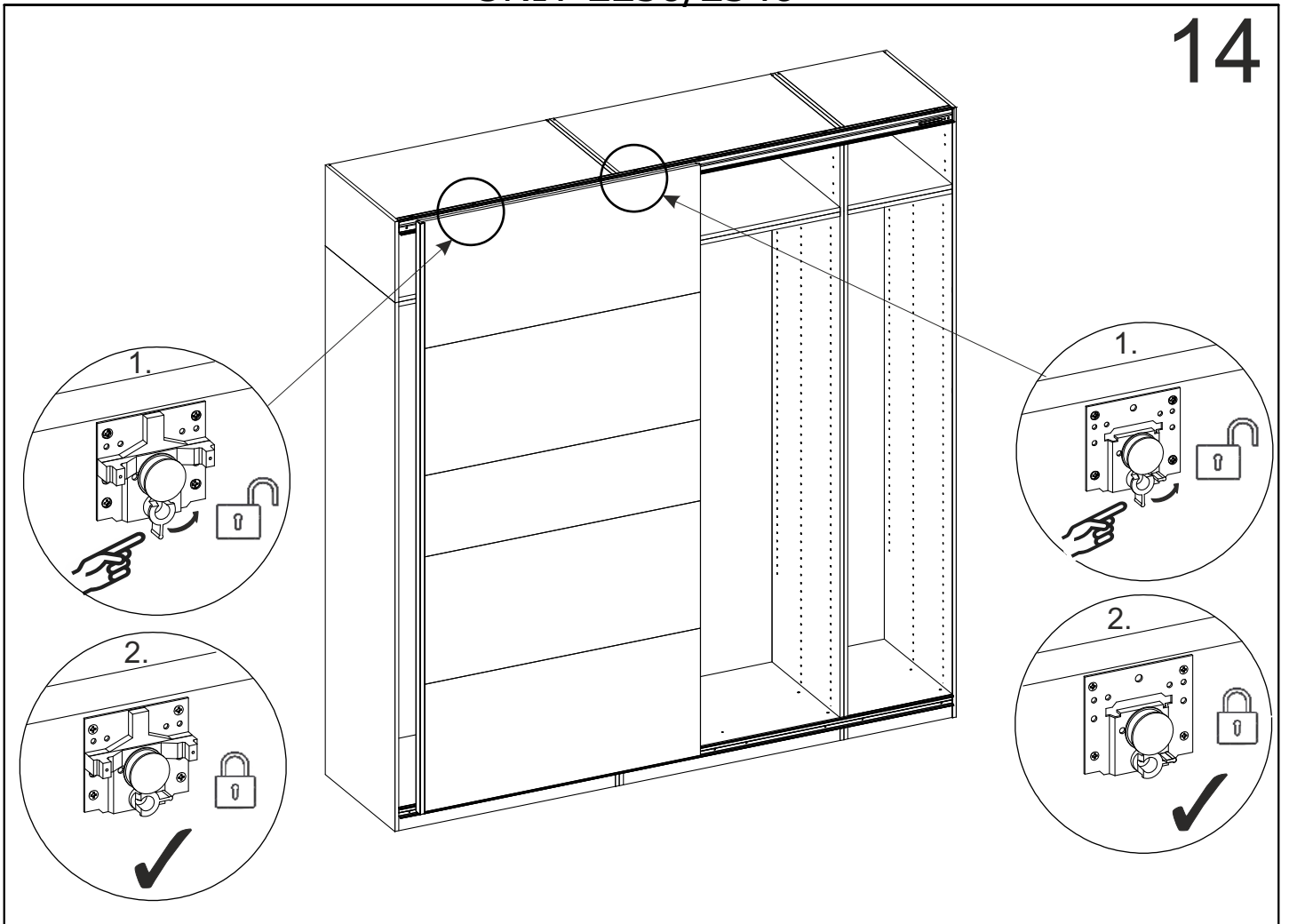

UNIT 2250/2346

16

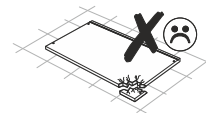
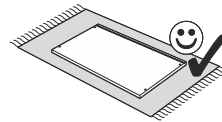
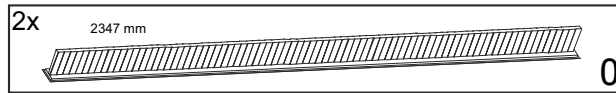
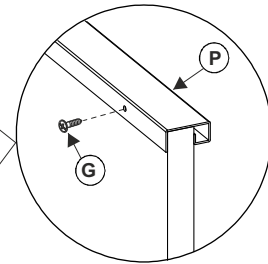
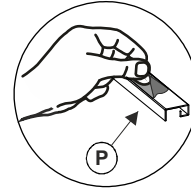
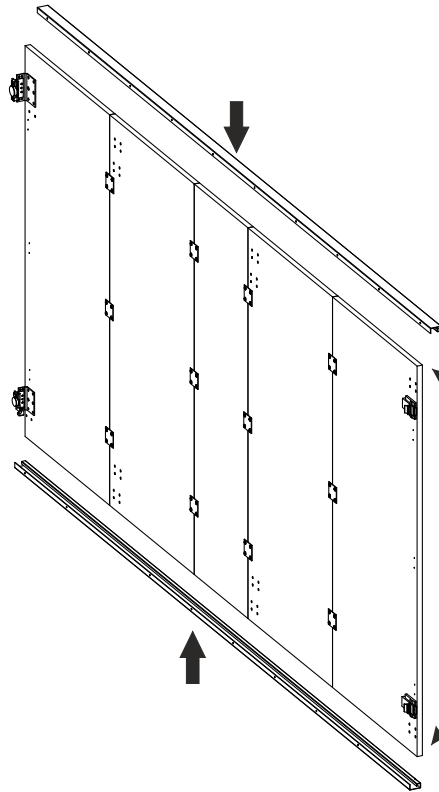
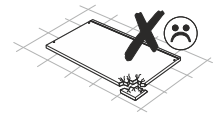
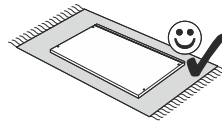
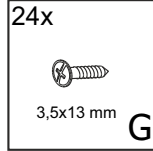

17

