

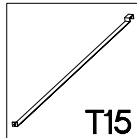

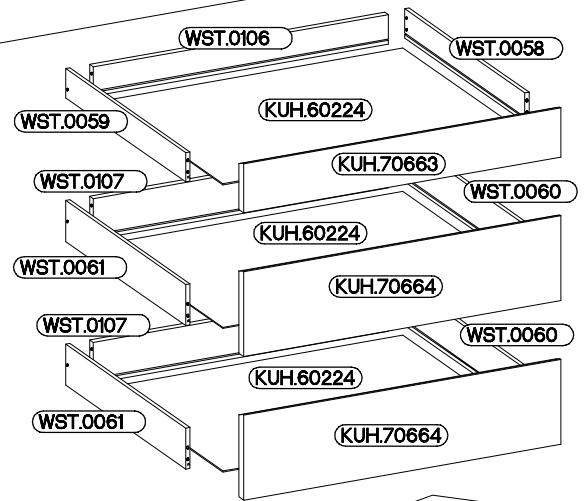

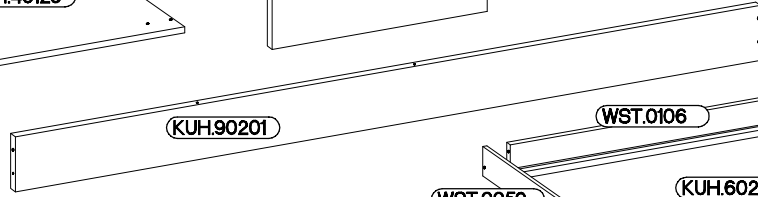

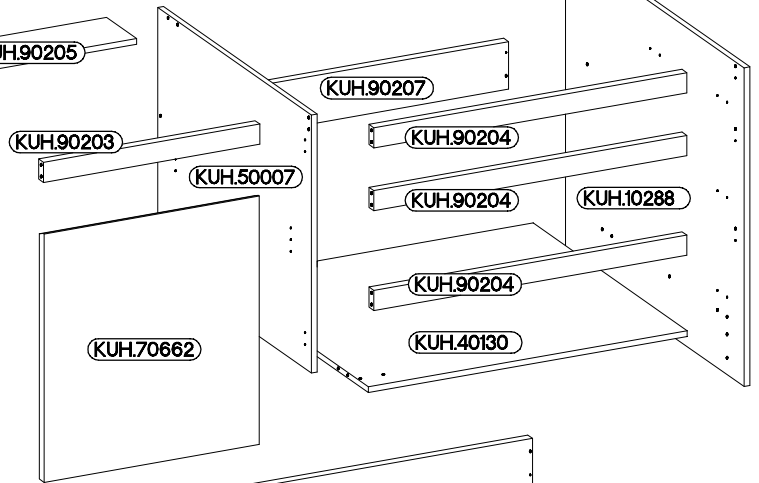

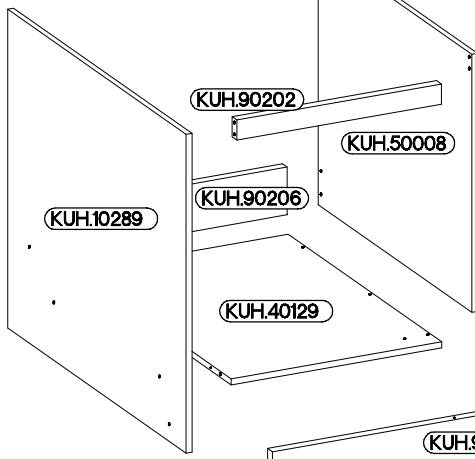
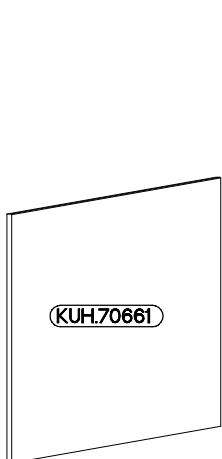
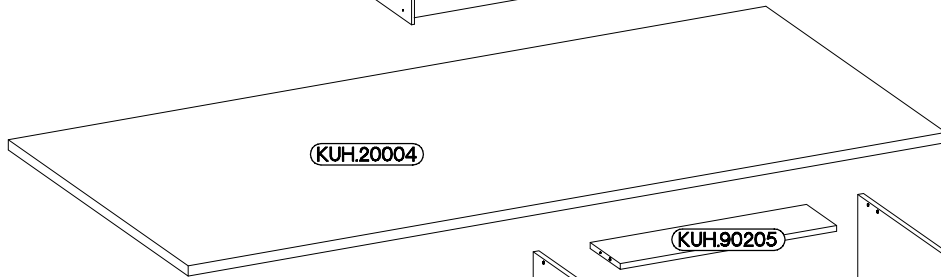













max.  
10kg



T15

3

 A	 B	 B2	 C	 D2	 D4	 E1
42	20	10	10	6	2	10
 HG2	 F2	 F4	 F15	 I8	 J5	 L
2	4	2	2	3	2	12
 L13	 L19	 M2	 O11	 O	 P	 P5
6	2	24	1	1	30	16

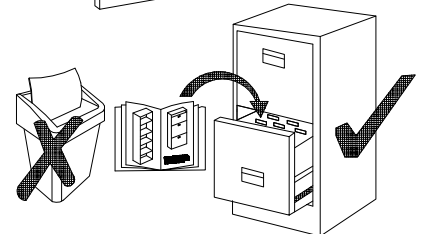

ISM-KUH-00855

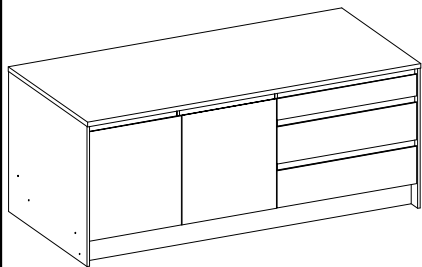

**Colli  
1/7**

KUH.10288	870x595x16mm	x1
KUH.40129	583x512x16mm	x1
KUH.40130	883x512x16mm	x1
KUH.50007	704x512x16mm	x1
KUH.50008	704x512x16mm	x1
WST.0058	450x80x12mm	x1
WST.0059	450x80x12mm	x1
WST.0060	450x140x12mm	x2
WST.0061	450x140x12mm	x2

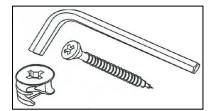
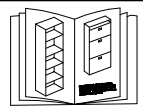

**Colli  
2/7**

KUH.10289	870x595x16mm	x1
KUH.60224	449x838x2,5mm	x3
KUH.70661	579x678x16mm	x1
KUH.70662	596x678x16mm	x1
KUH.70663	879x134x16mm	x1
KUH.70664	879x232x16mm	x2
WST.0106	826x80x12mm	x1
WST.0107	826x140x12mm	x2

**Colli  
3/7**

KUH.20004	2100x600x28mm	x1
KUH.90201	2066x150x16mm	x1
KUH.90202	567x55x16mm	x1
KUH.90203	600x55x16mm	x1
KUH.90204	867x55x16mm	x3
KUH.90205	600x100x16mm	x1
KUH.90206	567x130x16mm	x1
KUH.90207	867x130x16mm	x1

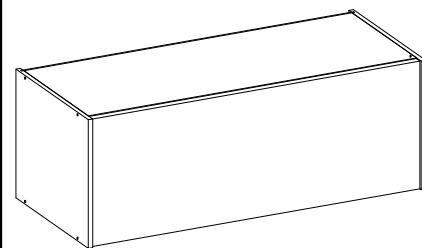

**Colli  
4/7**

KUH.10290	450x309x16mm	x2
KUH.30055	575x240x16mm	x2
KUH.40132	1167x276x16mm	x2
KUH.50009	416x275x16mm	x1
KUH.60225	446x592x2,5mm	x1
KUH.60226	446x592x2,5mm	x1
KUH.70665	1163x446x16mm	x1

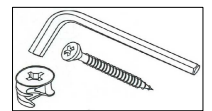
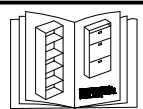

**Colli  
5/7**

KUH.30056	583x475x16mm	x1
KUH.30057	265x507x16mm	x4
KUH.40134	584x511x16mm	x1
KUH.40135	584x511x16mm	x1
KUH.70666	596x1254x16mm	x1
KUH.70667	596x499x16mm	x1
KUH.70668	596x60x16mm	x2
KUH.90209	599x113x16mm	x1
KUH.90210	584x55x16mm	x3
KUH.90211	266x55x16mm	x1

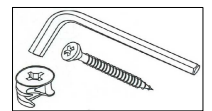
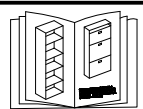

**Colli  
6/7**

KUH.10291	1446x595x16mm	x1
KUH.10292	1446x595x16mm	x1
KUH.20082	1500x596x16mm	x1
KUH.60227	408x600x2,5mm	x1
KUH.60228	600x600x2,5mm	x1
KUH.60229	1305x280x2,5mm	x1

**Colli  
7/7**

KUH.40133	1446x512x16mm	x1
KUH.50010	1280x512x16mm	x1
KUH.50011	1280x512x16mm	x1
KUH.90208	1466x150x16mm	x1

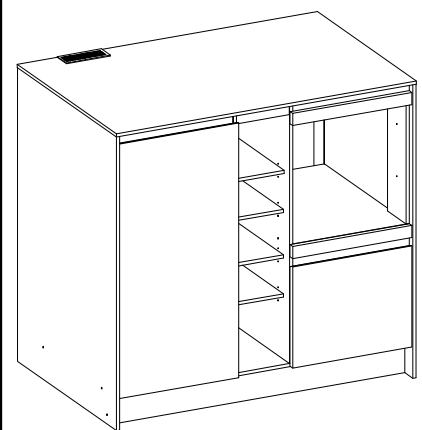

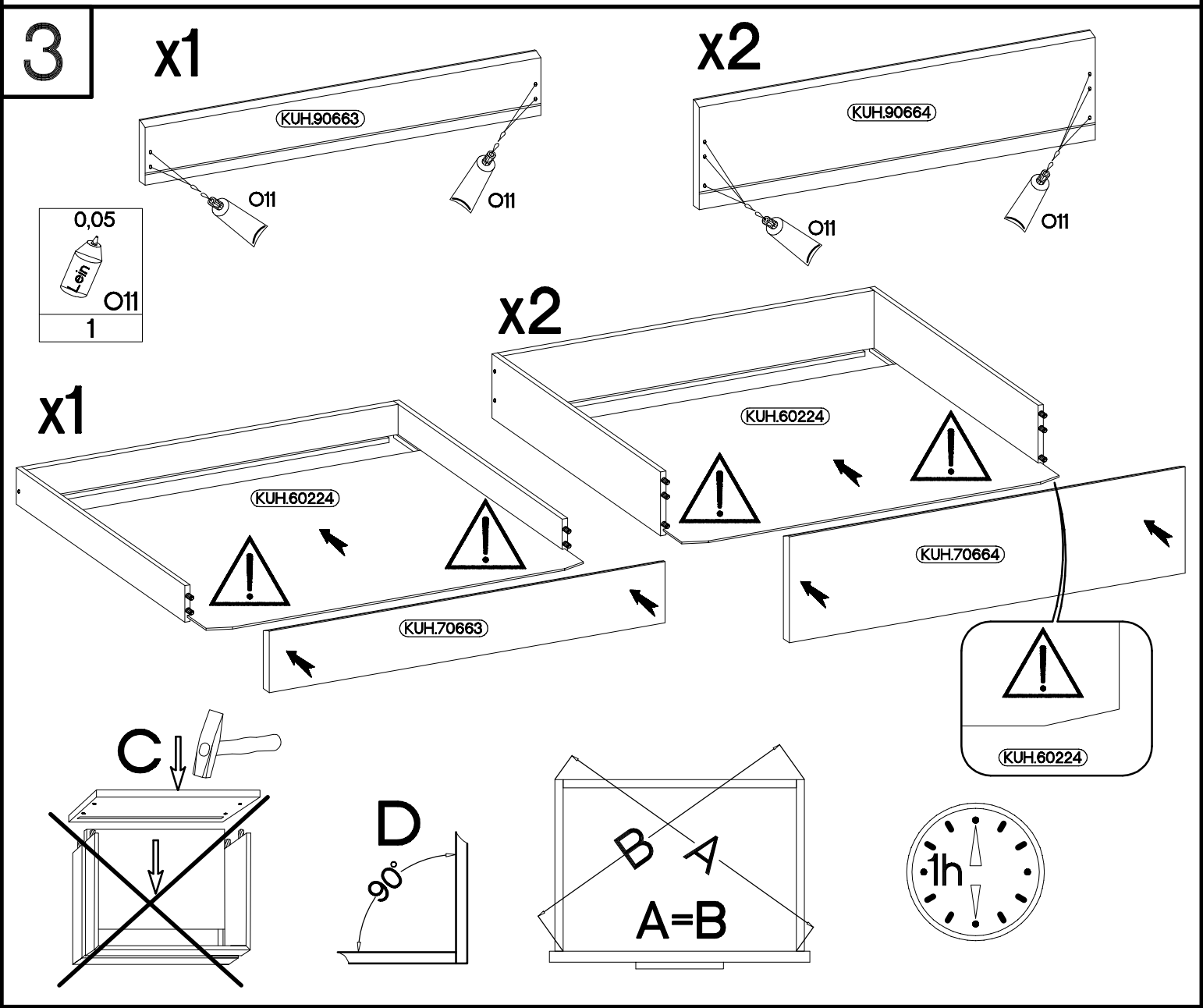
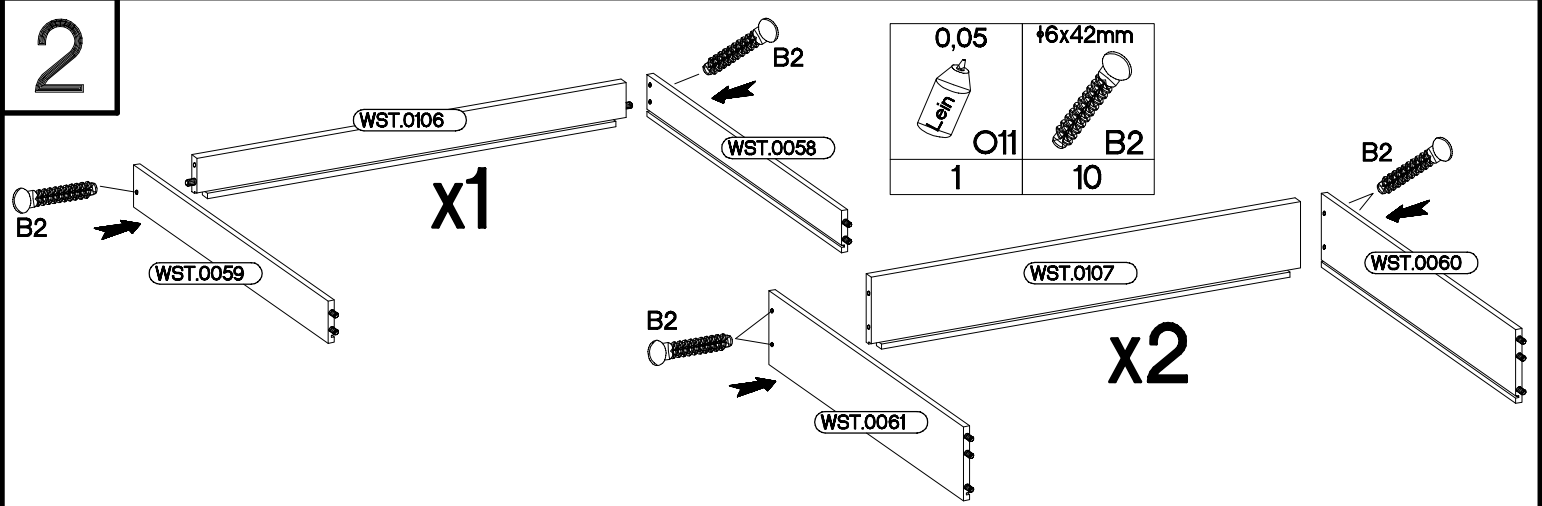
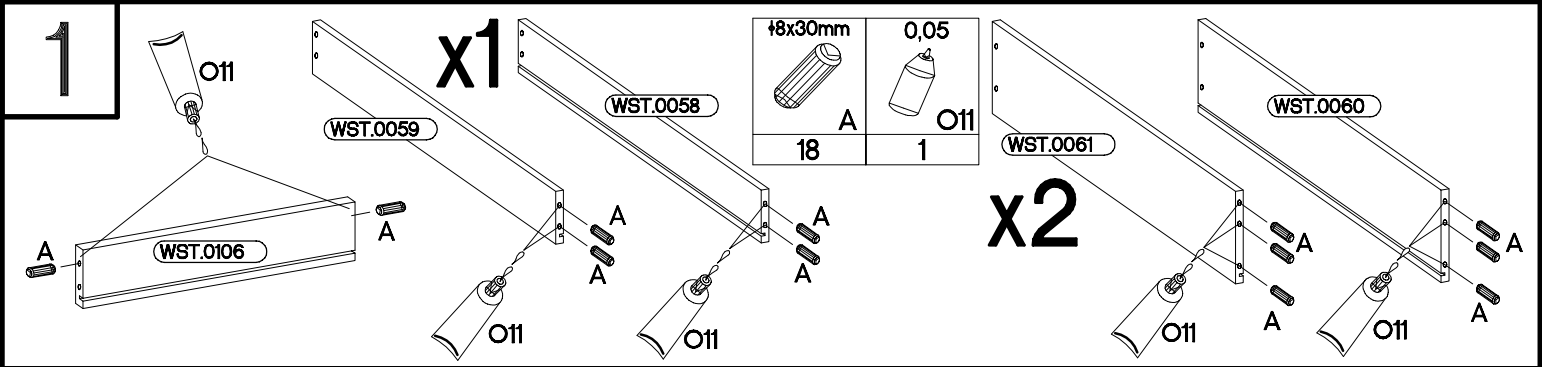



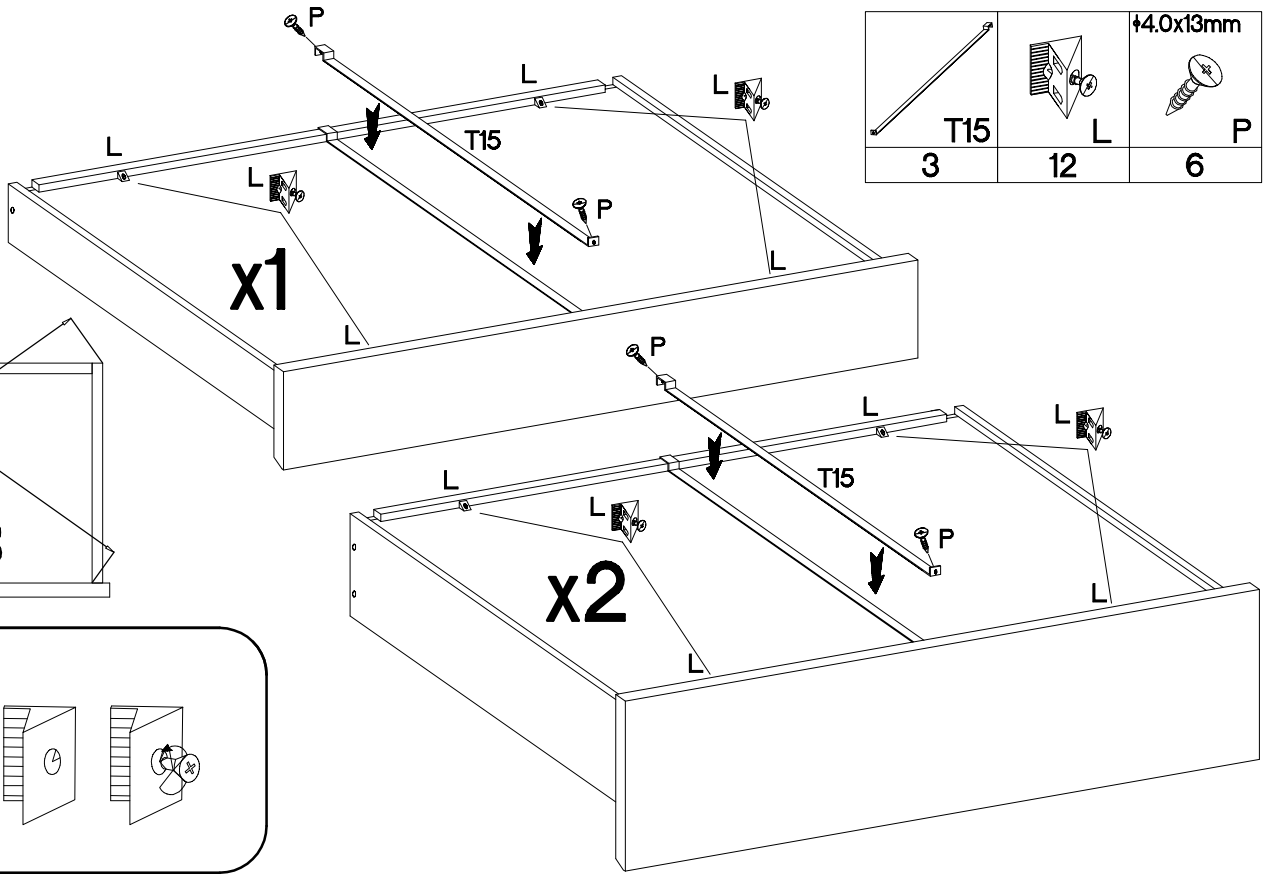



4

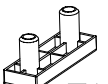

5

						
±15/12mm	L=20mm	±8x30mm	6.5x48x16	±6,3x13mm	L=450mm	±15x5mm
C	D2	A	F2	M2	I8	F4
10	6	24	4	24	3	2

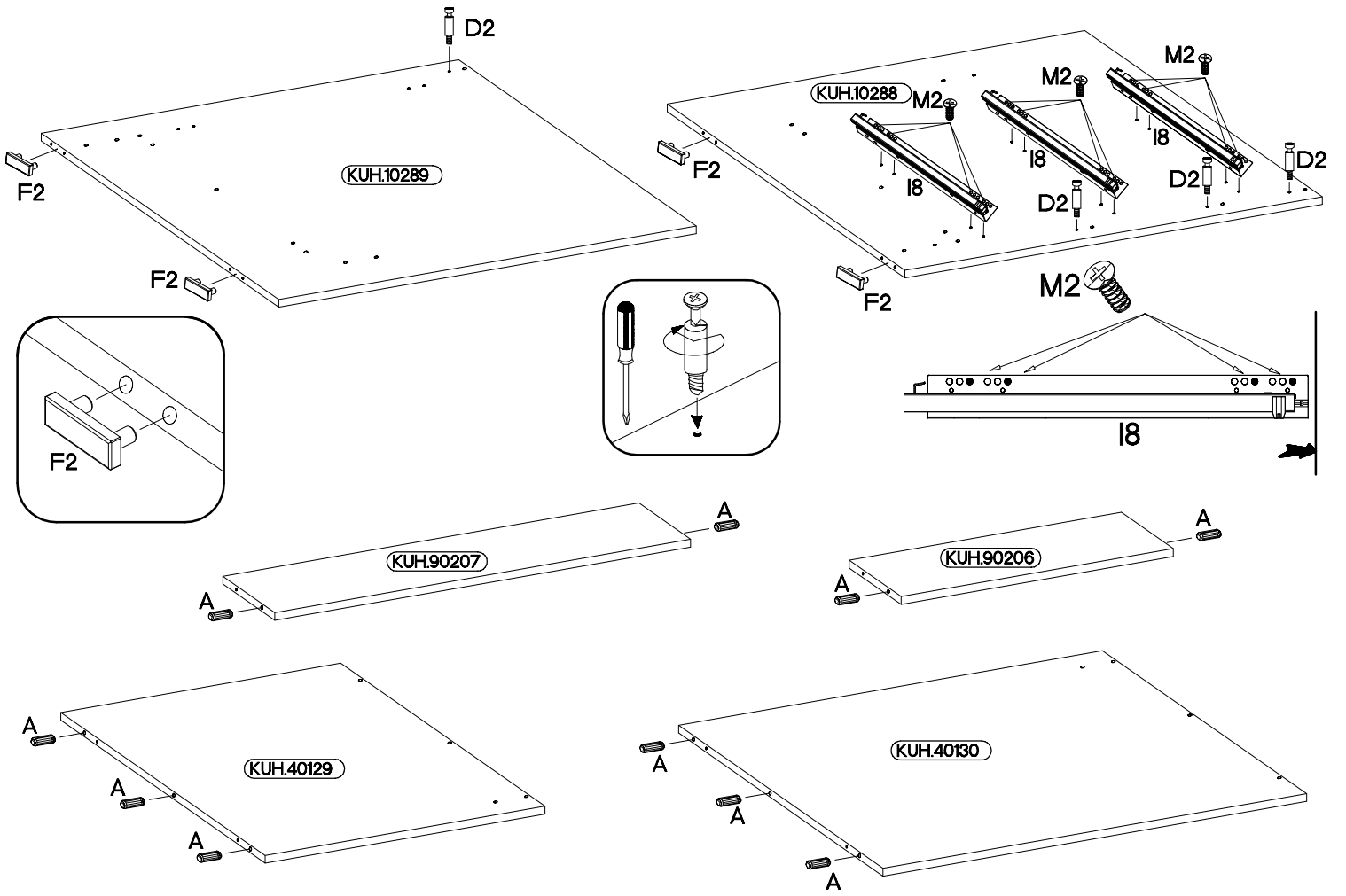



6

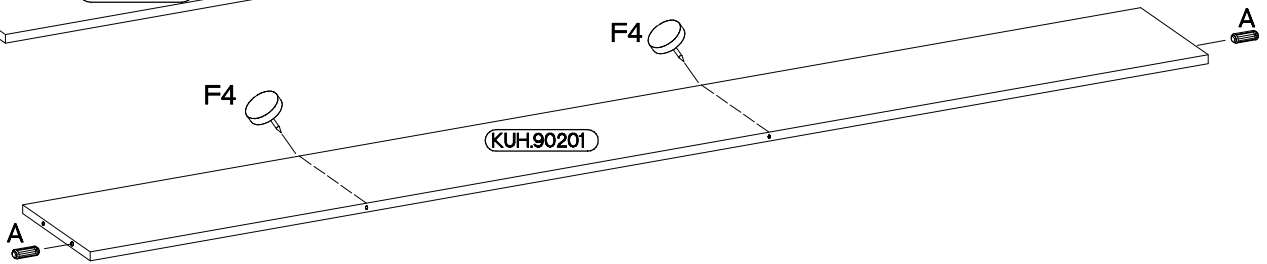
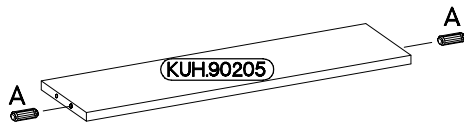
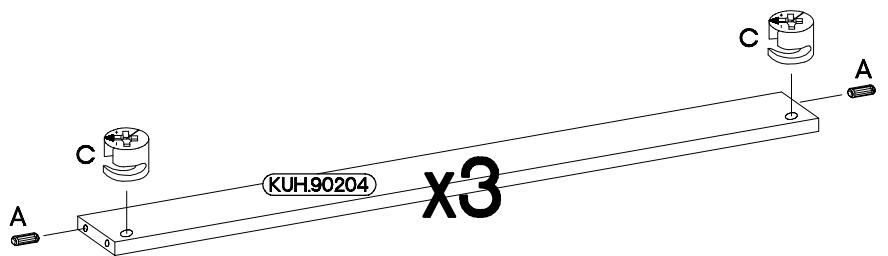
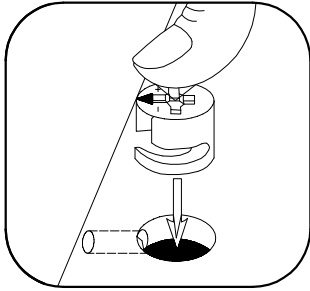
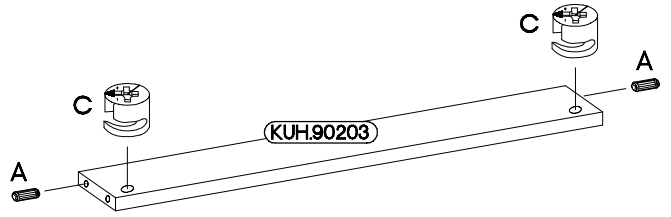
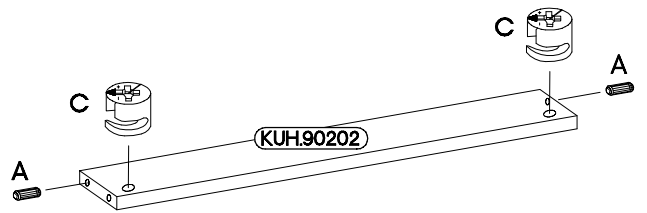
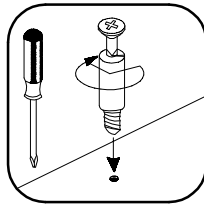
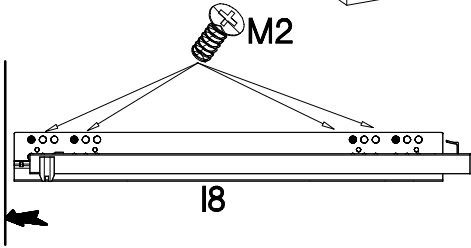
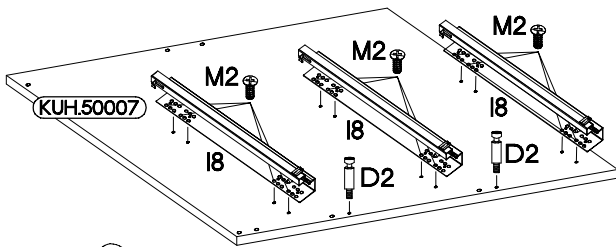

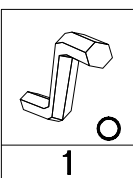
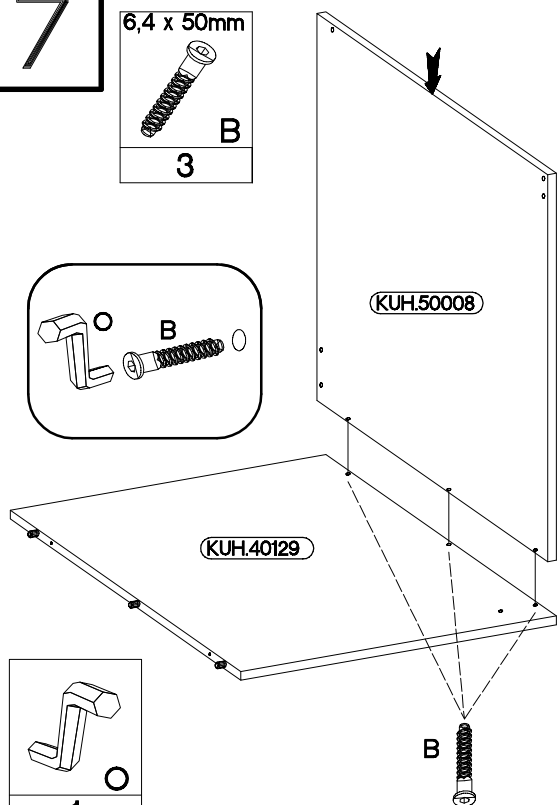
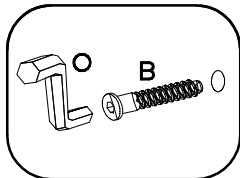
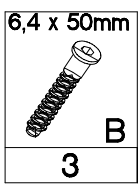

7

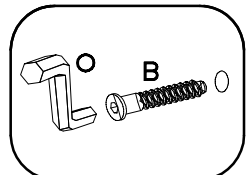
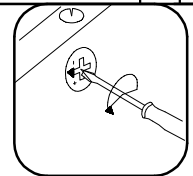
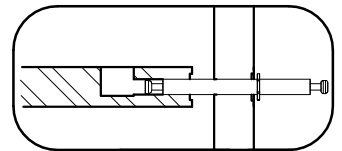
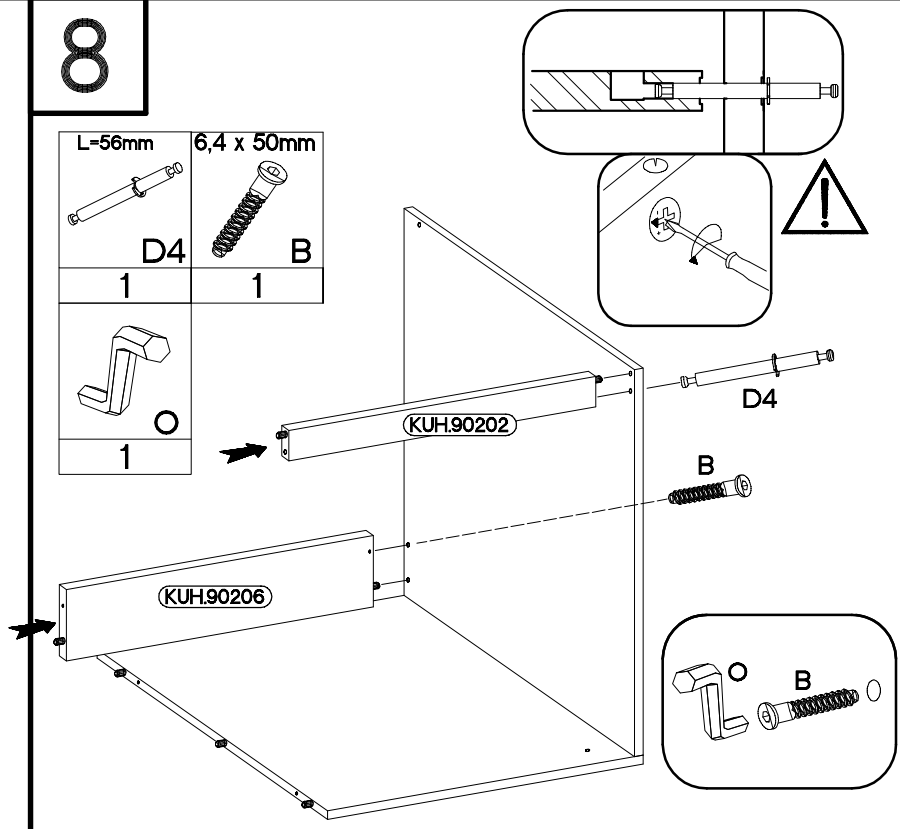
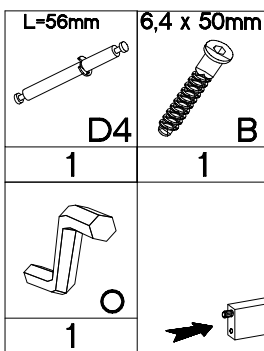

8



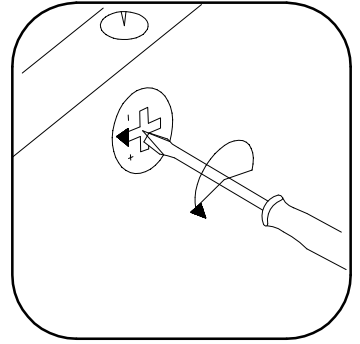
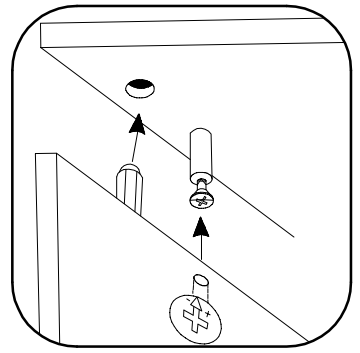
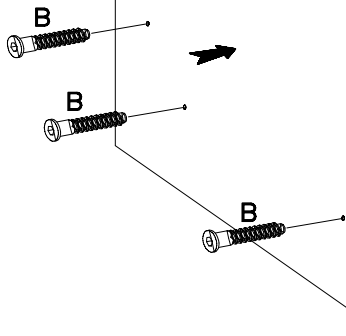
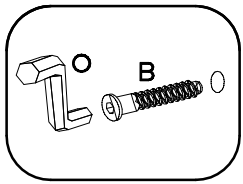

9

6,4 x 50mm	
	
B	O
3	1

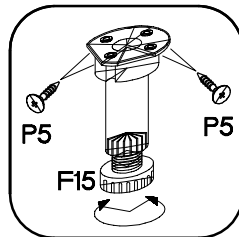

10



#3.5x13mm	
	
P5	F15
4	1

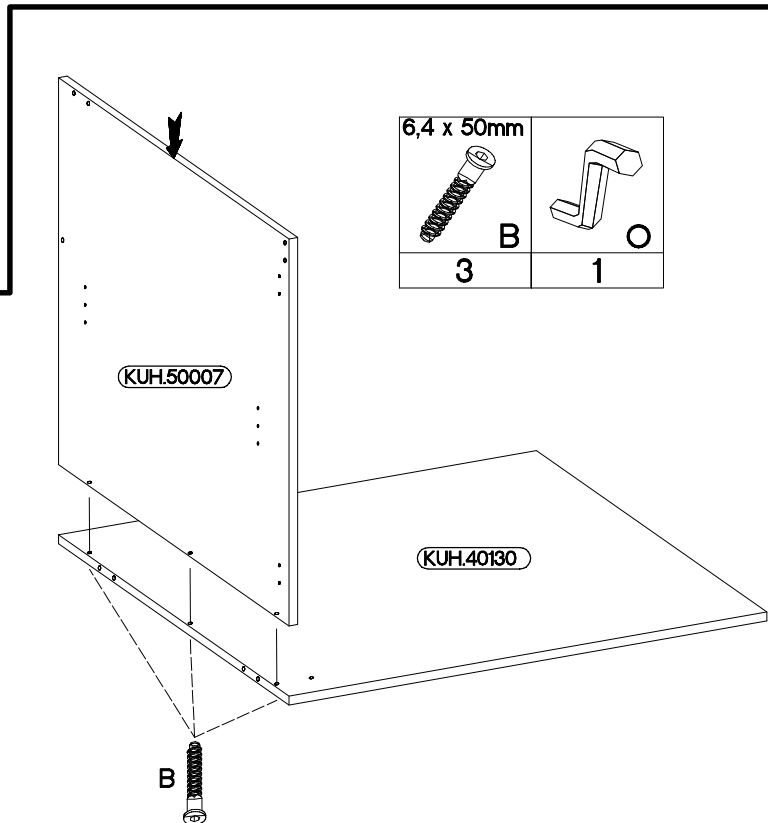
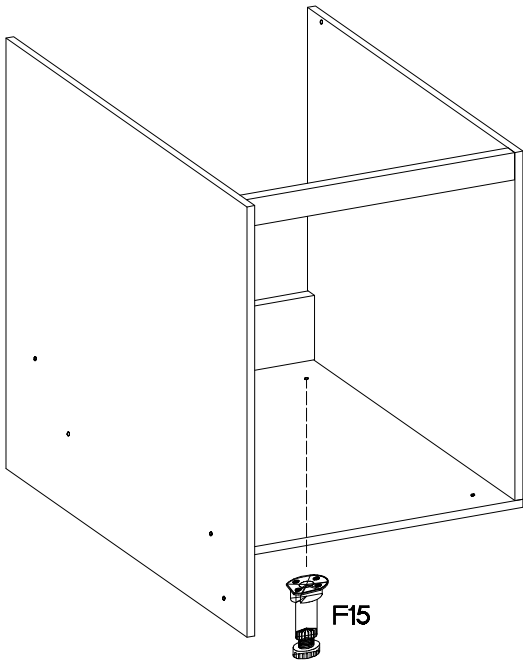

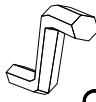

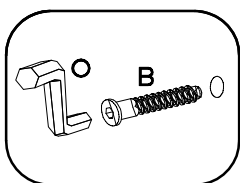
6,4 x 50mm	
	
B	O
3	1



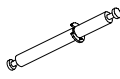

11

12

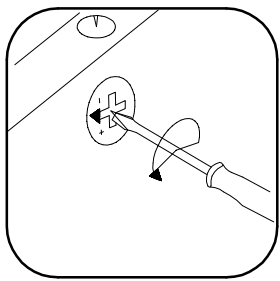
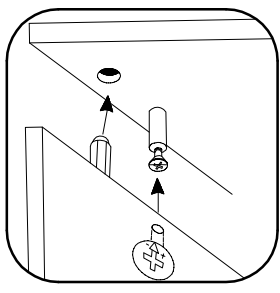
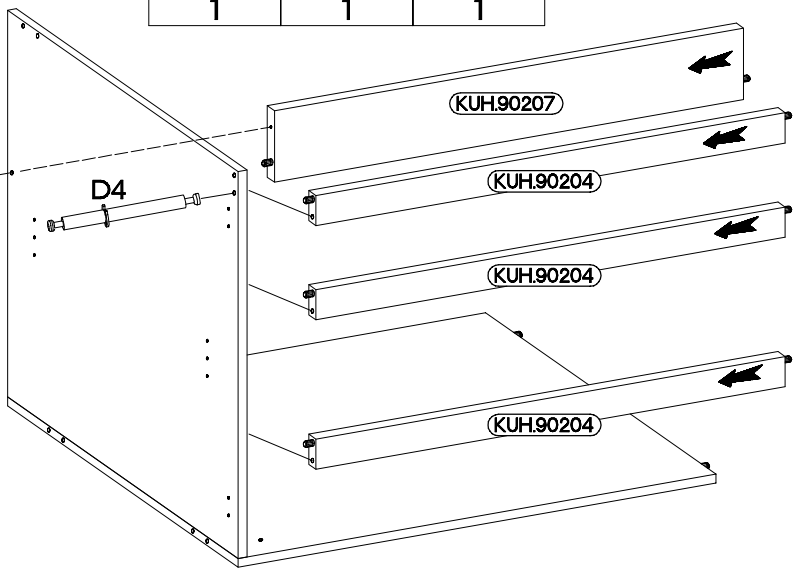
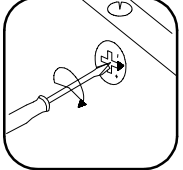
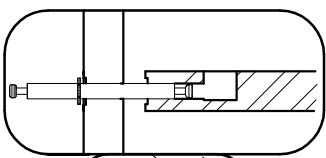
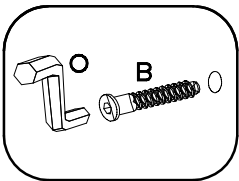
L=56mm	6,4 x 50mm	
		
D4	B	O
1	1	1



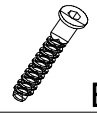

13

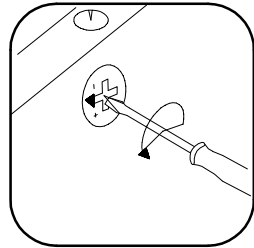
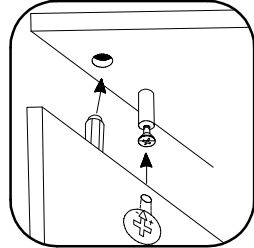
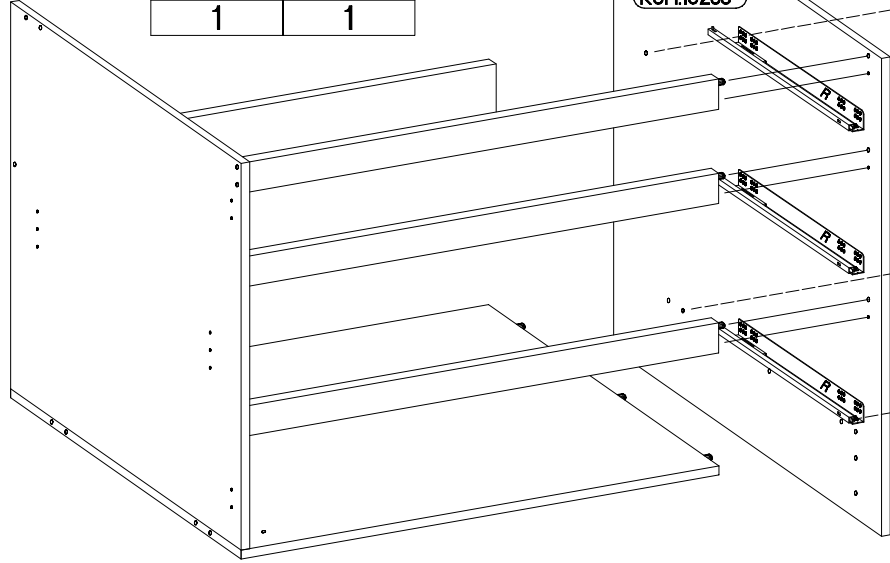
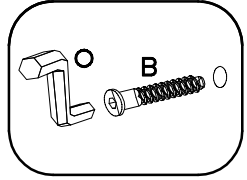
6,4 x 50mm	
	
B	O
1	1



14

±3.5x13mm	
	
P5	F15
4	1

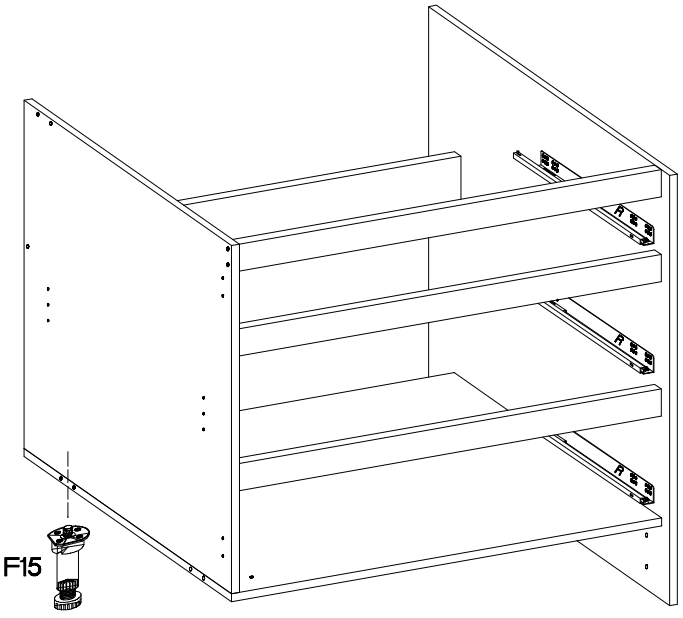
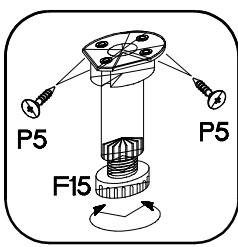

# 15

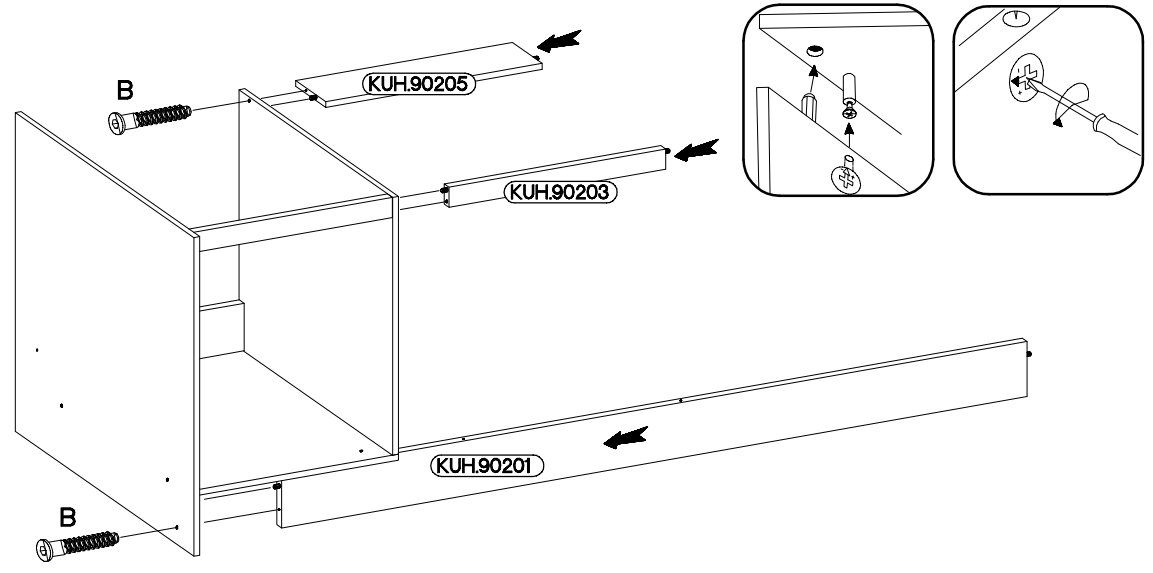
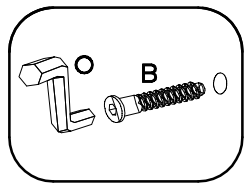
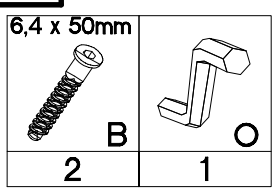

# 16

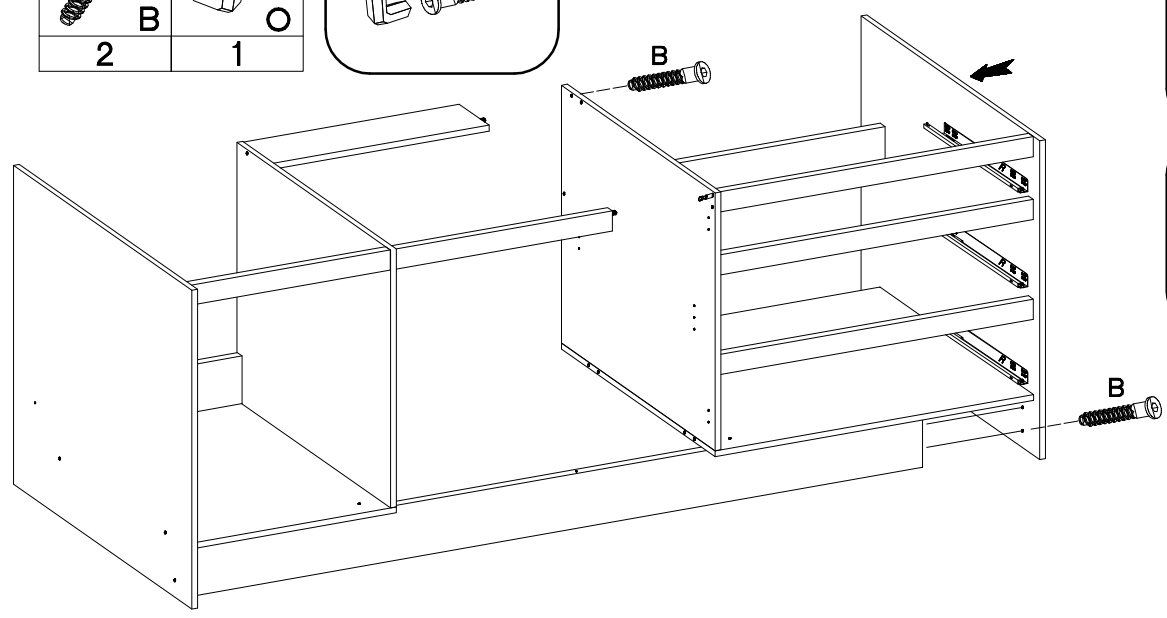
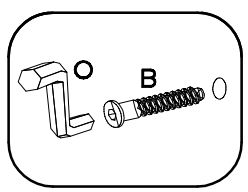
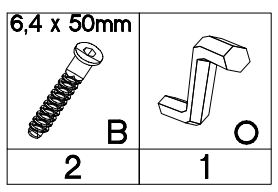

# 17

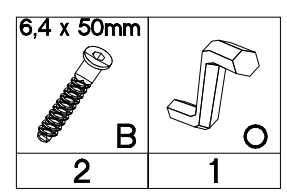
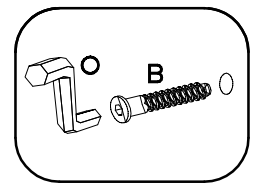
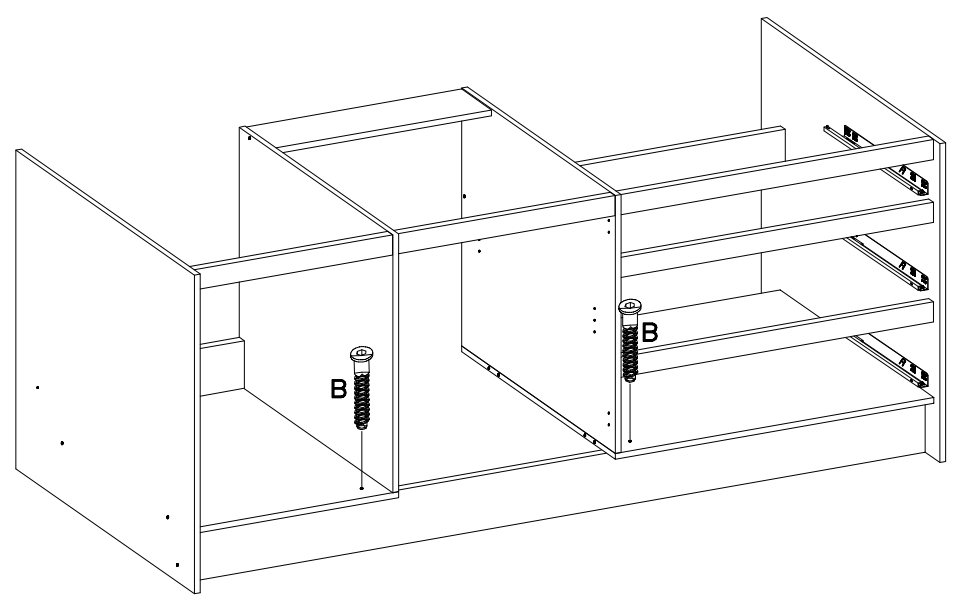

# 18

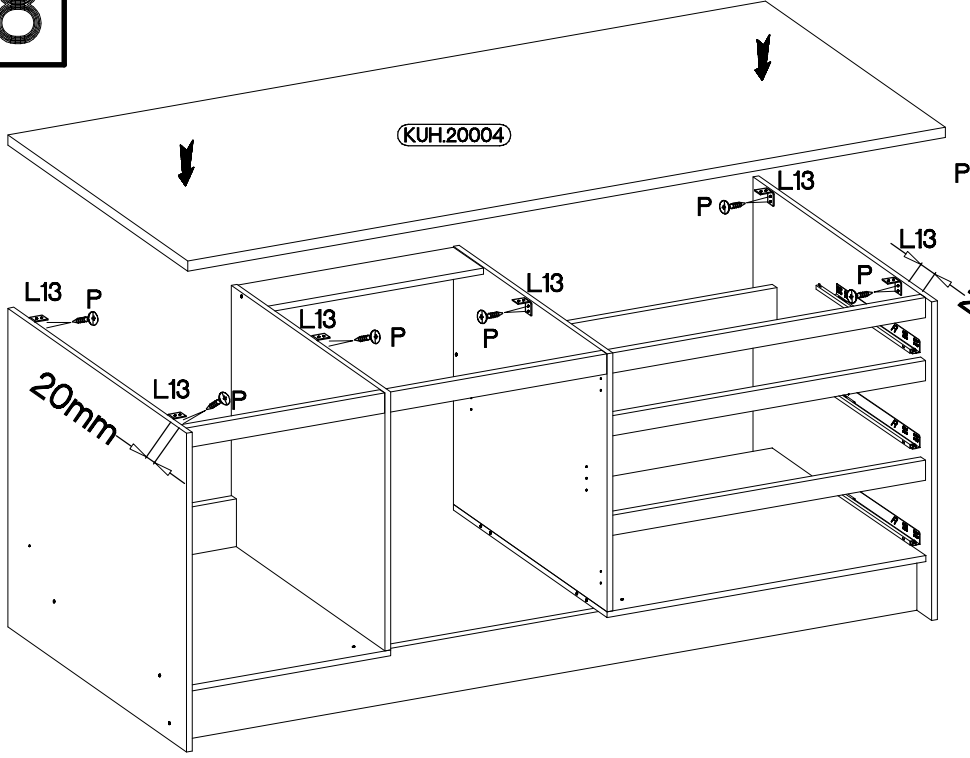

	+4.0x13mm
L13	P
6	24

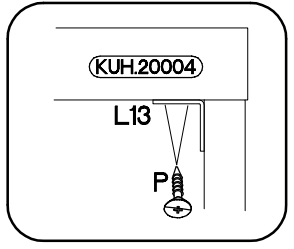
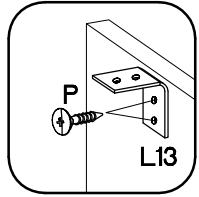

# 19

	+3.5x13mm
HG2	P5
2	4
J5	
2	

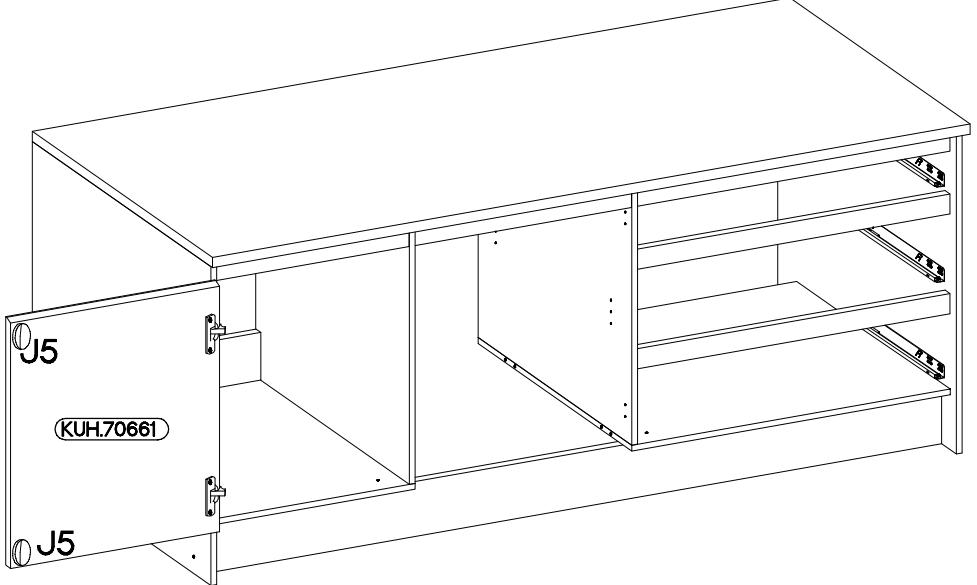
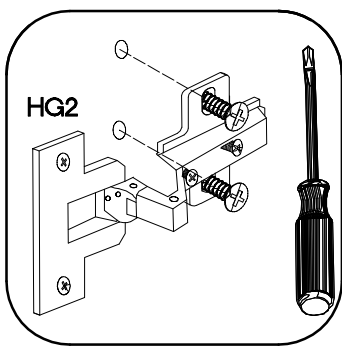
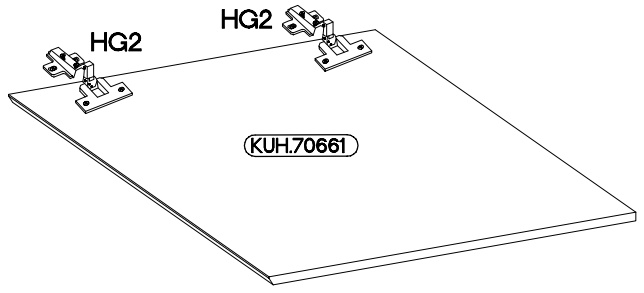
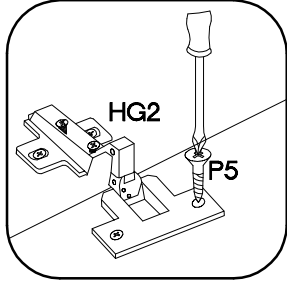

E1
10

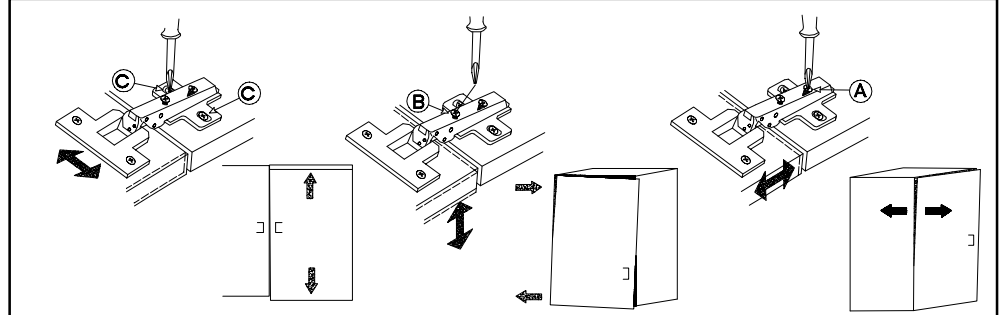
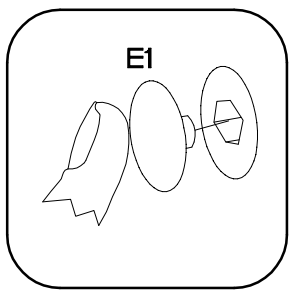

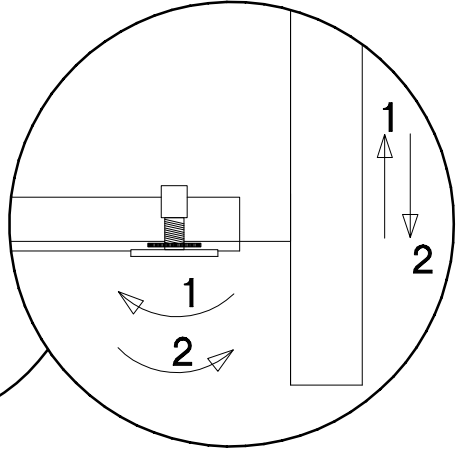
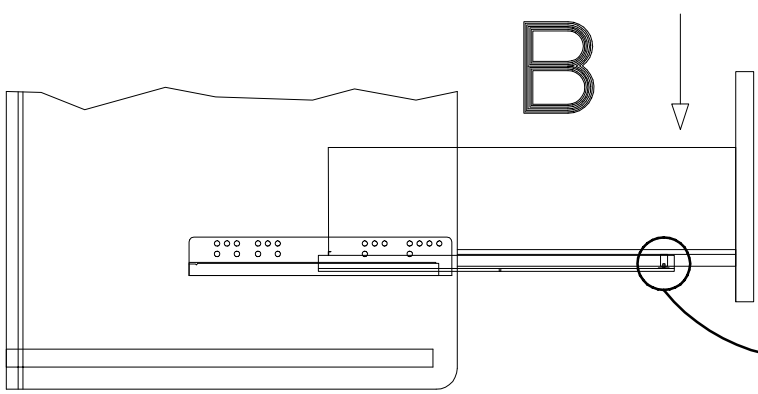
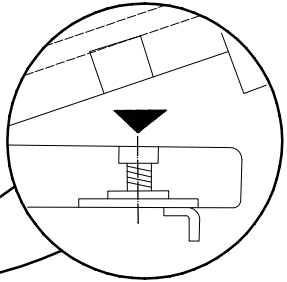
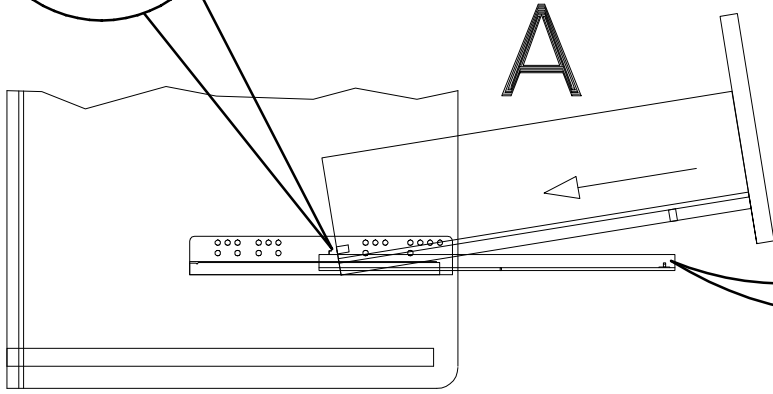
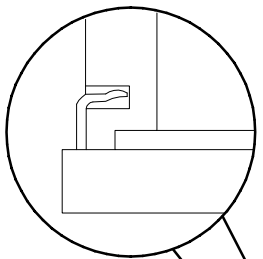
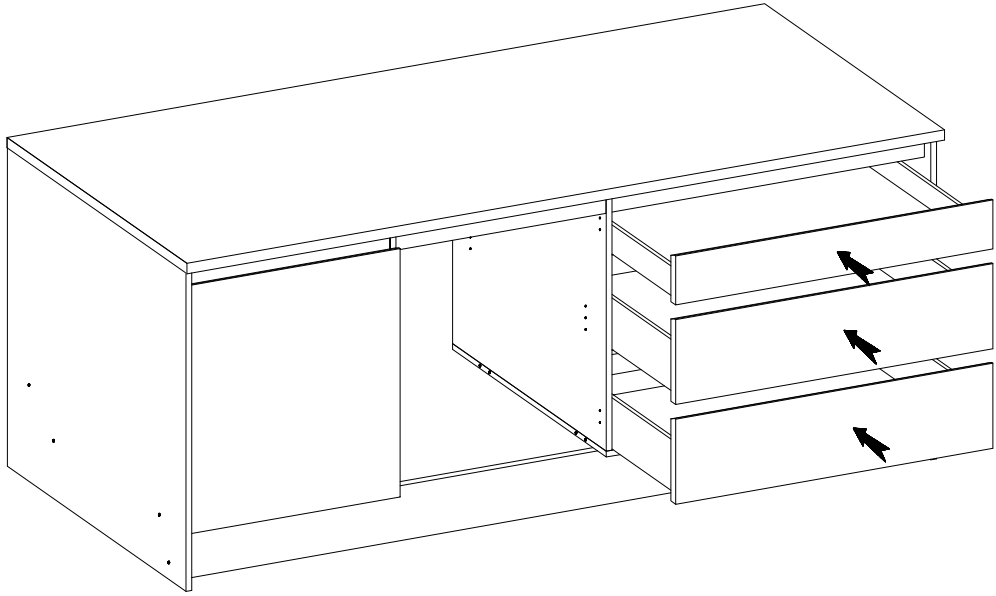

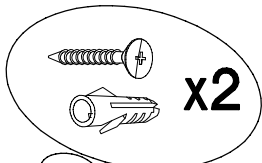

#3.5x13mm	
P5	L19
4	2

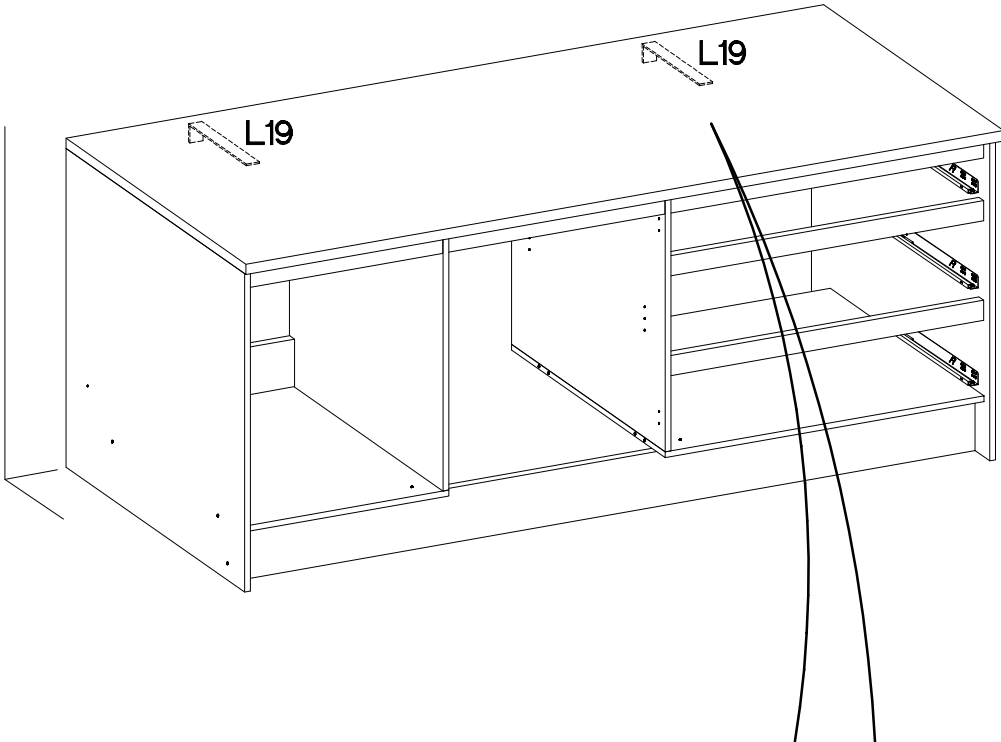
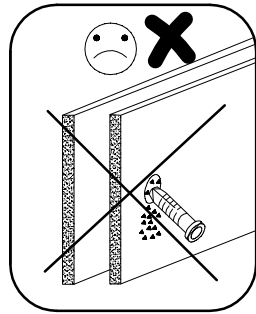
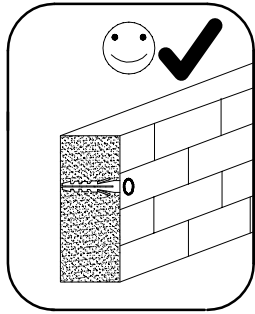

- 
- 
- 
- 
-