

MALTA MYK8

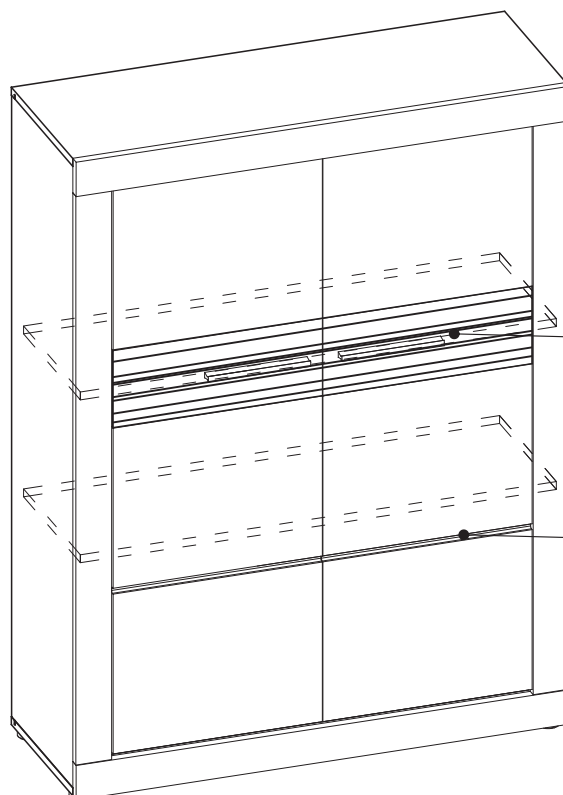
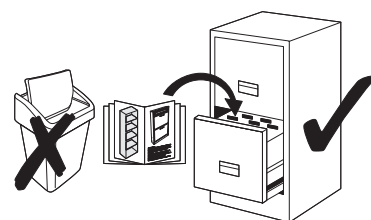

 max.
5 kg

 max.
5 kg

- | | | |
|--------|--------|--------|
| ① - C4 | ⑥ - C4 | ⑪ - C5 |
| ② - C4 | ⑦ - C4 | ⑫ - C5 |
| ③ - C4 | ⑧ - C4 | ⑬ - C5 |
| ④ - C4 | ⑨ - C5 | ⑭ - C5 |
| ⑤ - C4 | ⑩ - C5 | ⑮ - C4 |

C1  1/6

C2  2/6

C3  3/6

C4  4/6

C5  5/6

C6  6/6

MALTA MYM01

MALTA MYK8

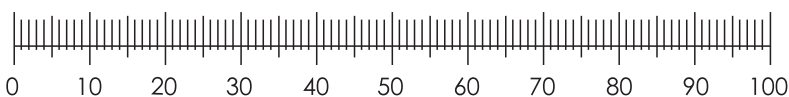
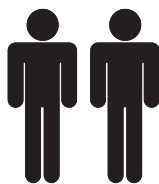
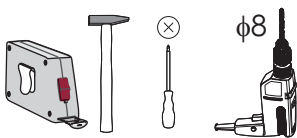
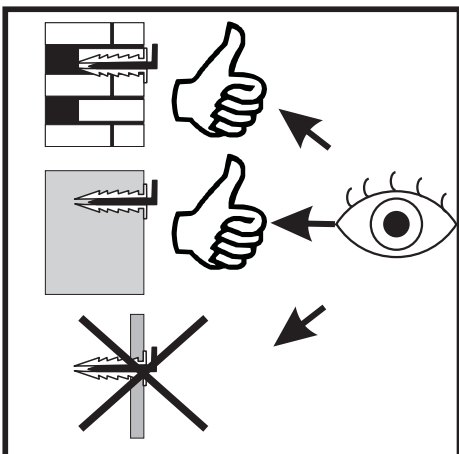
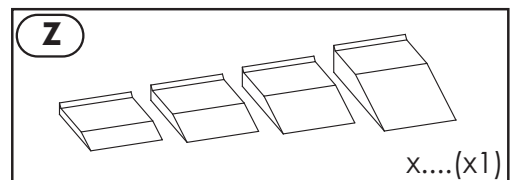
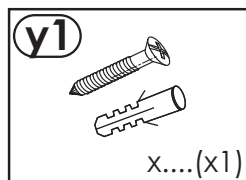
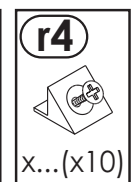
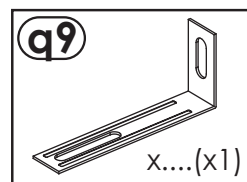
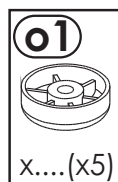
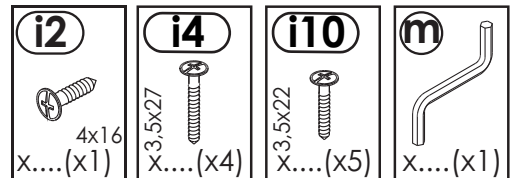
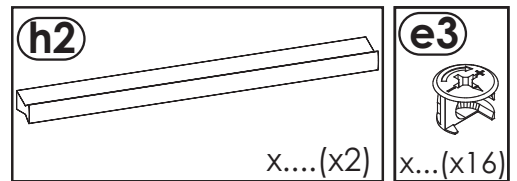
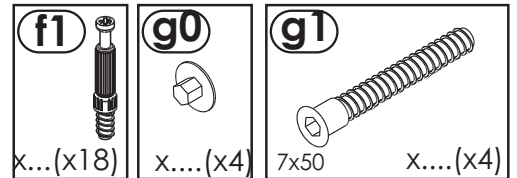
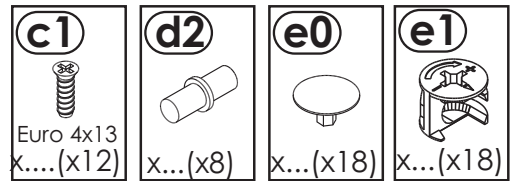
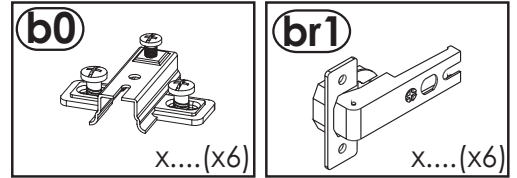
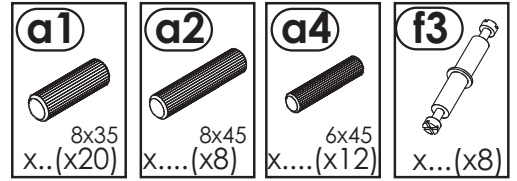
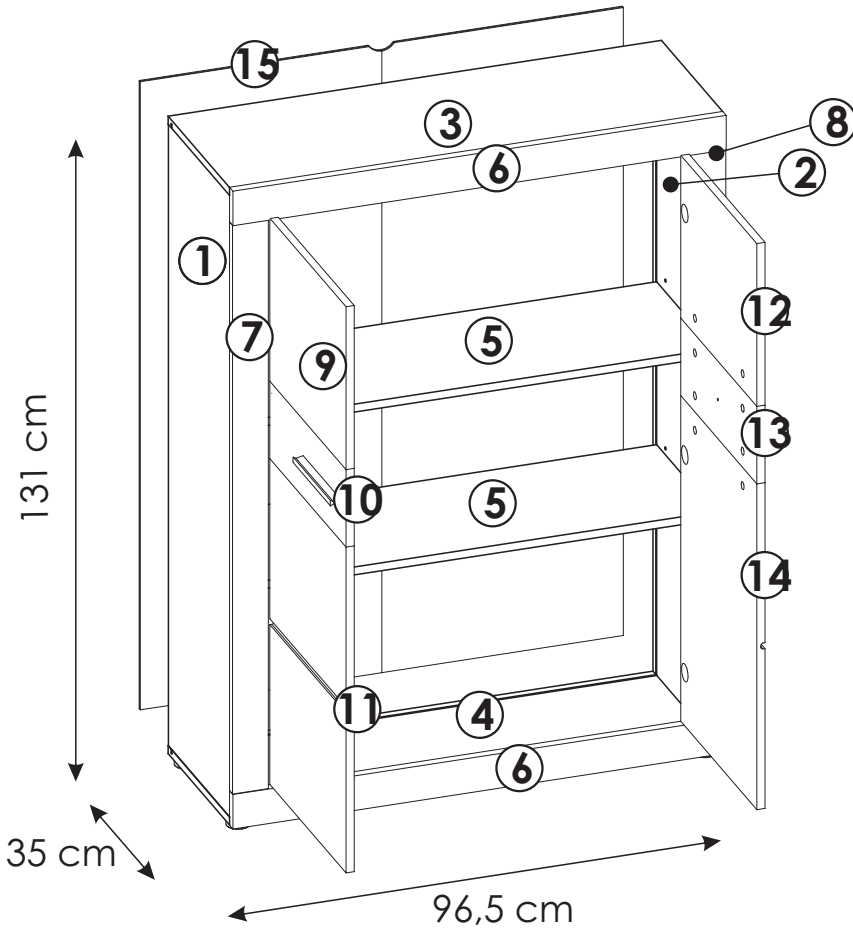

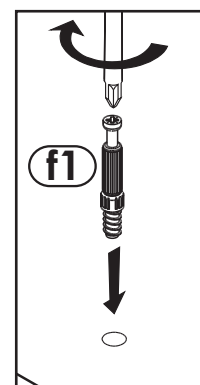
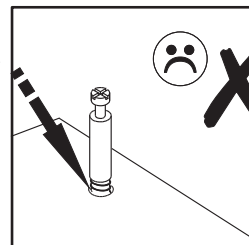
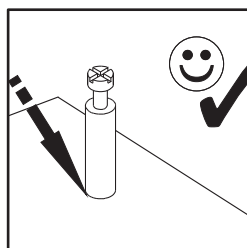
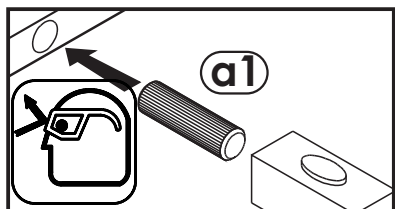
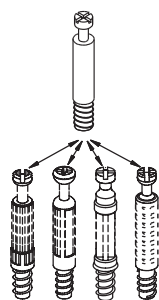
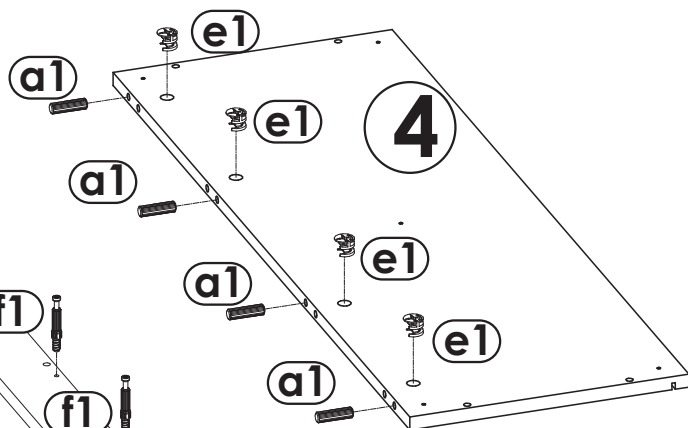
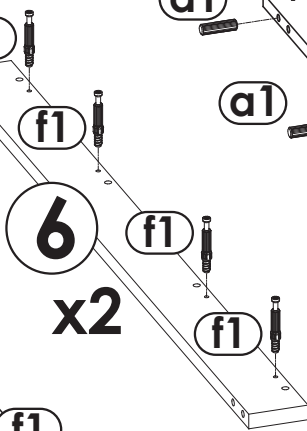
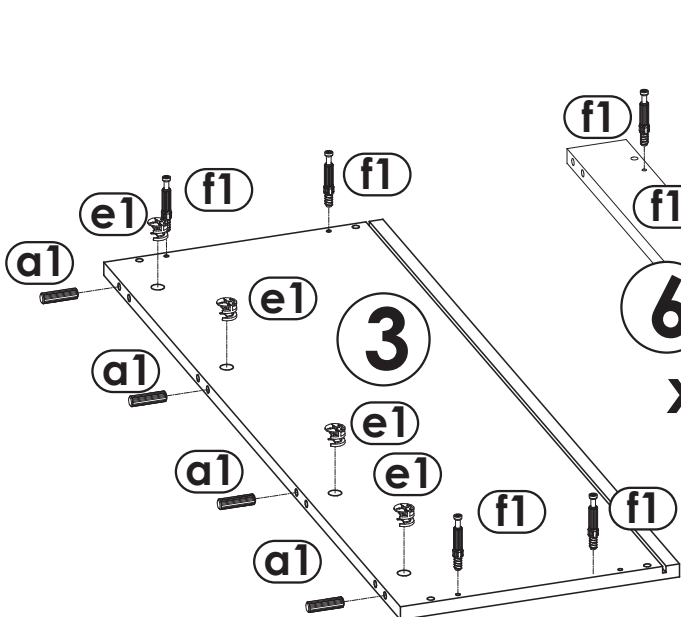
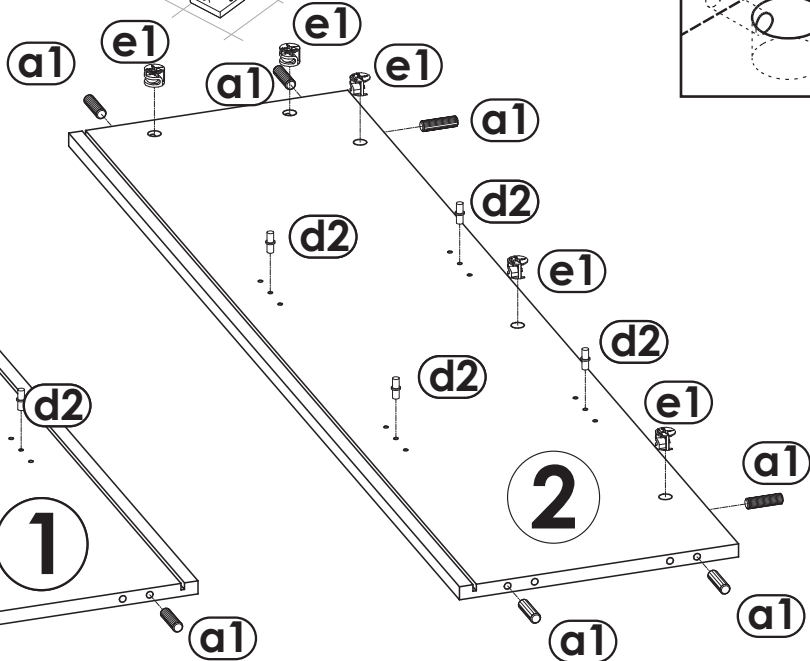
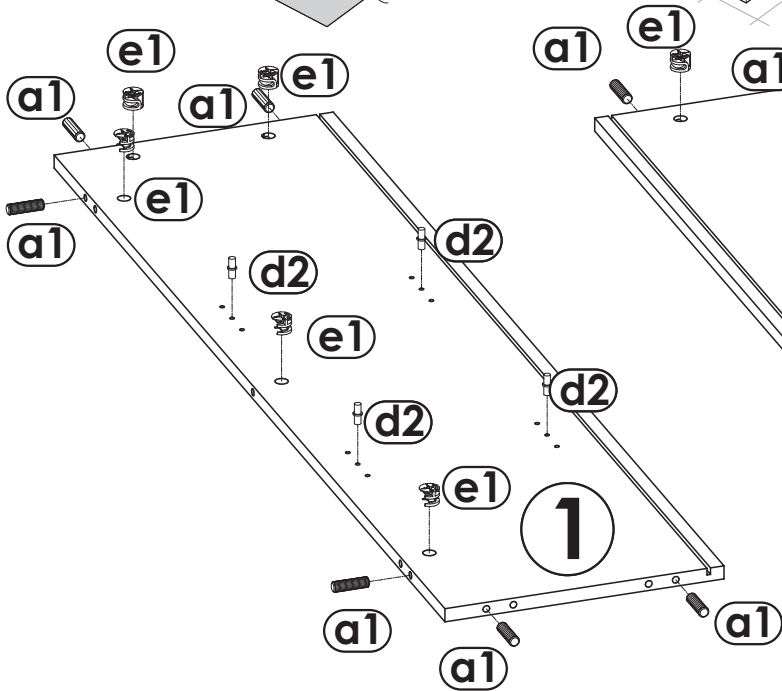
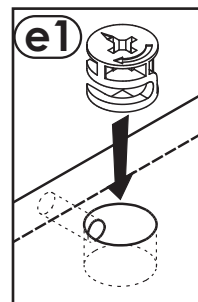
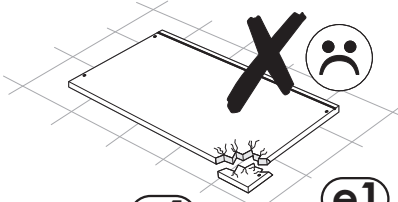
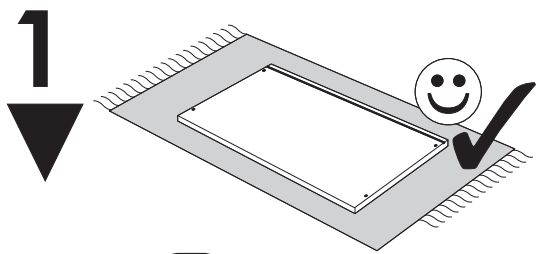

2

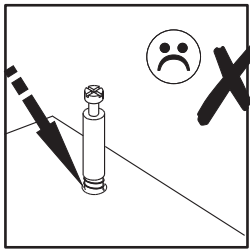
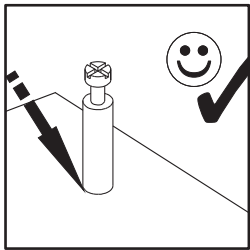
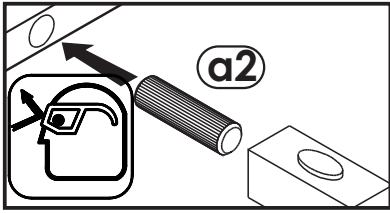
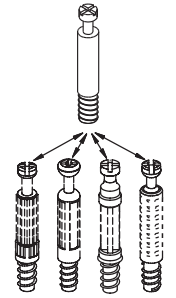
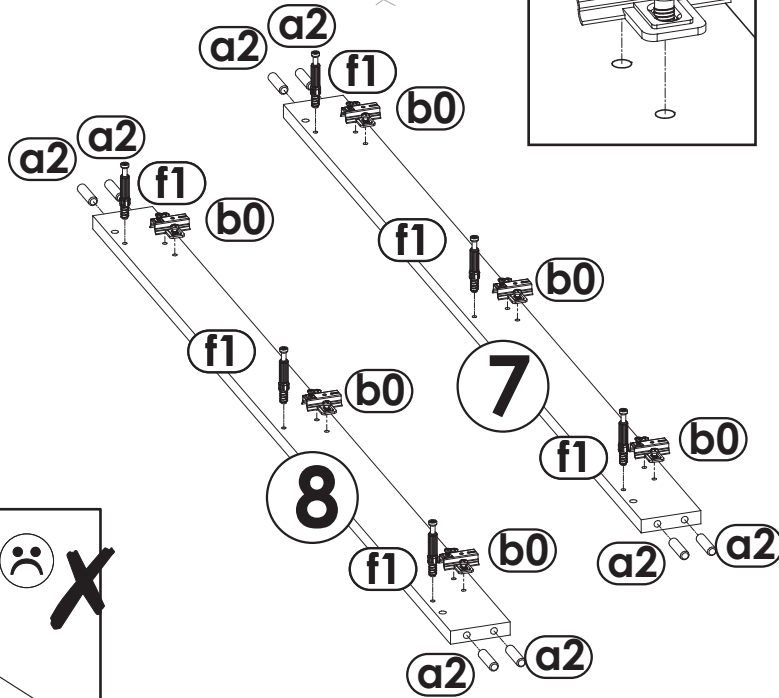
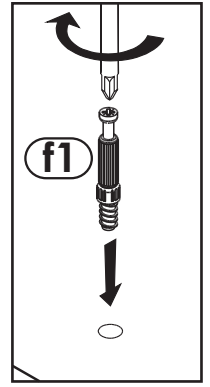
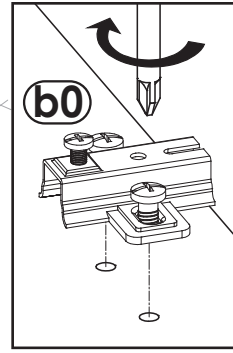
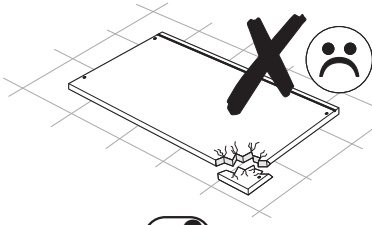
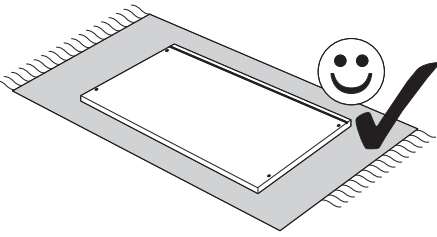

3

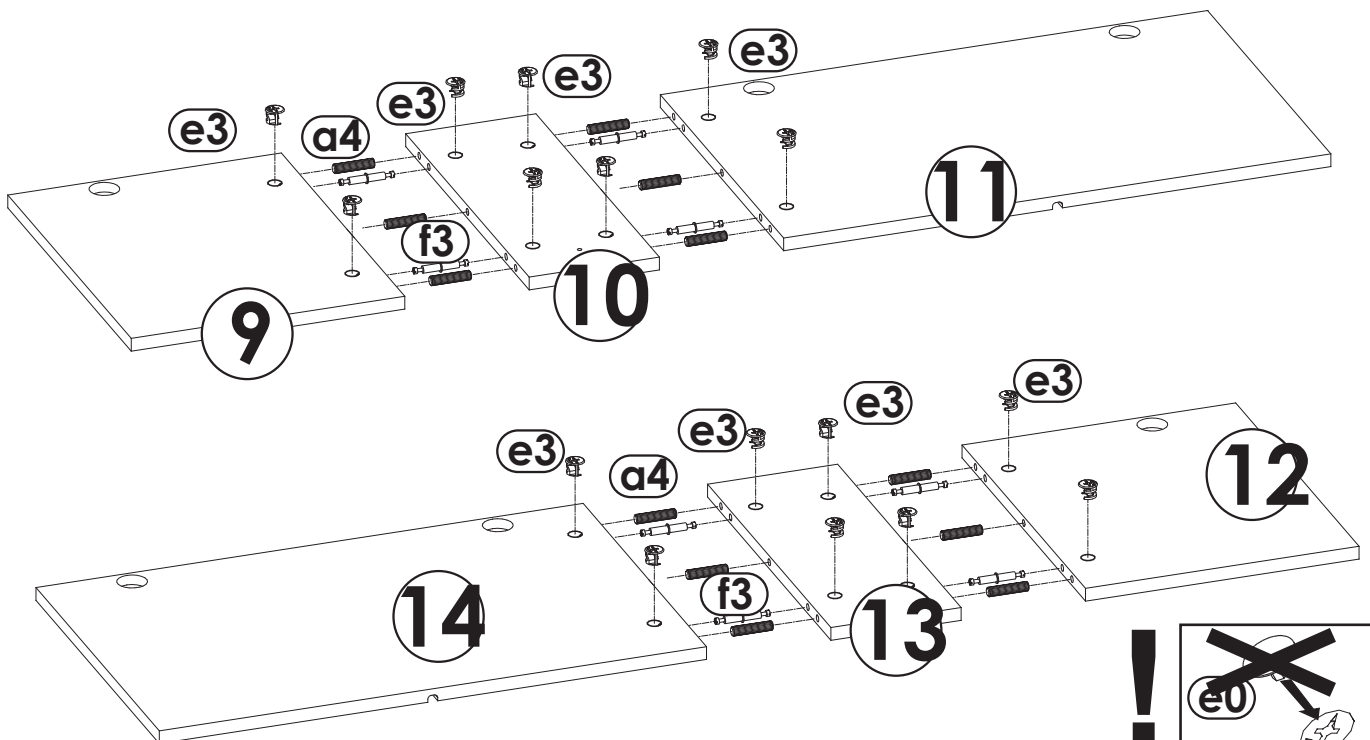
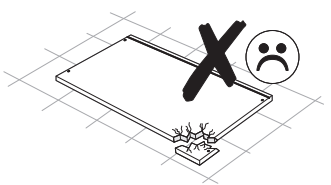
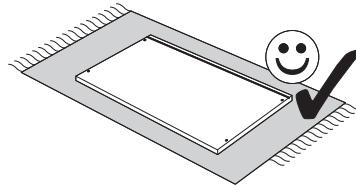
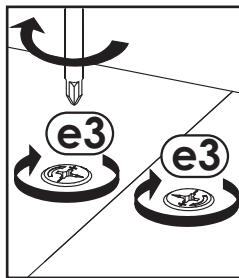
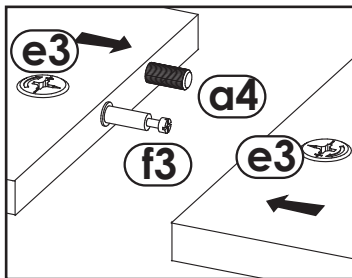

4

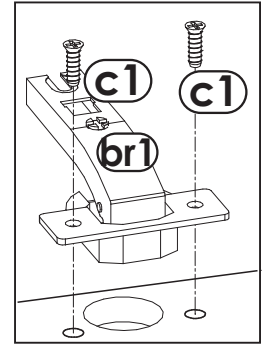
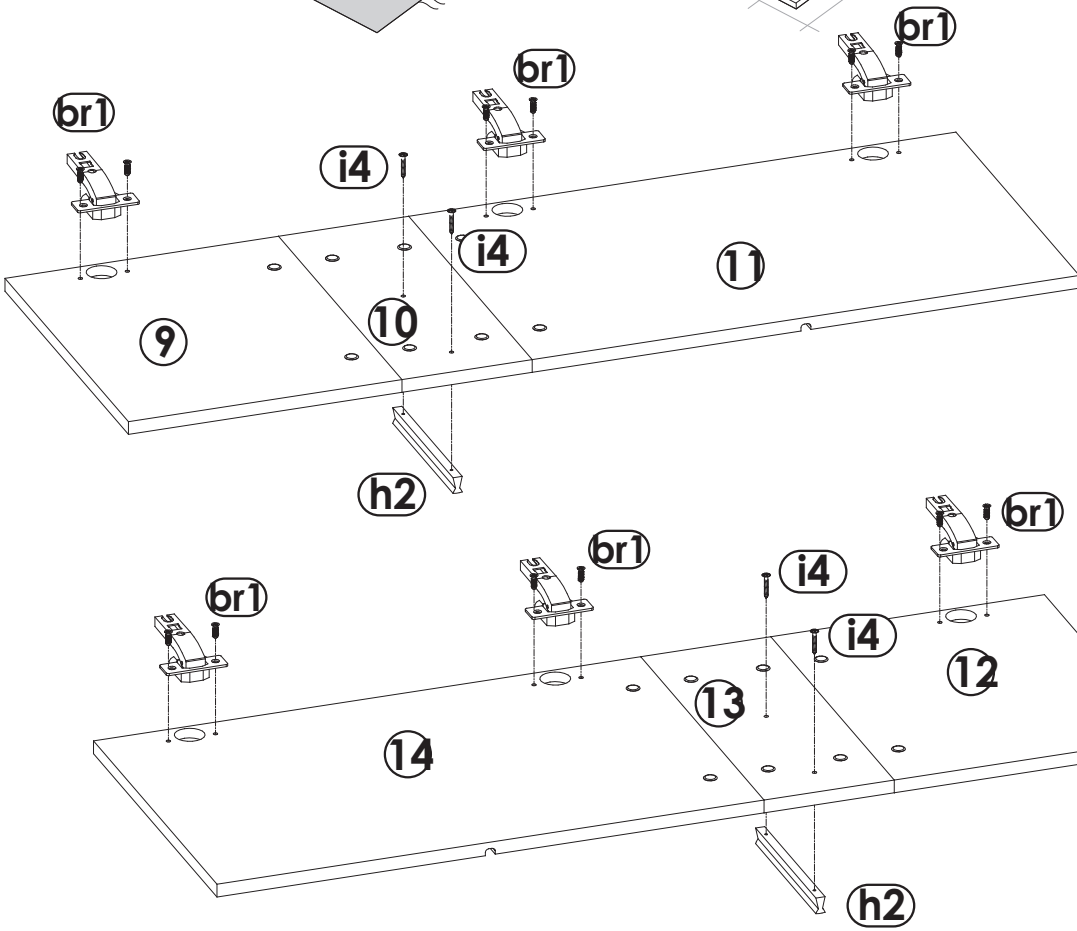
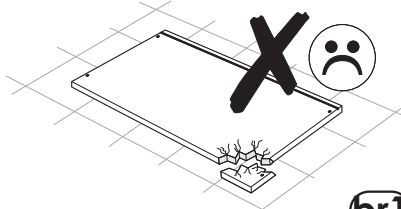
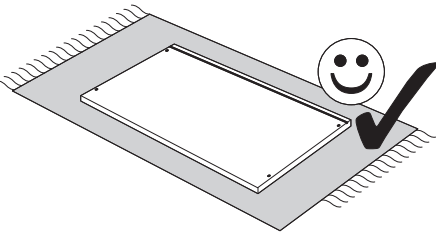

5

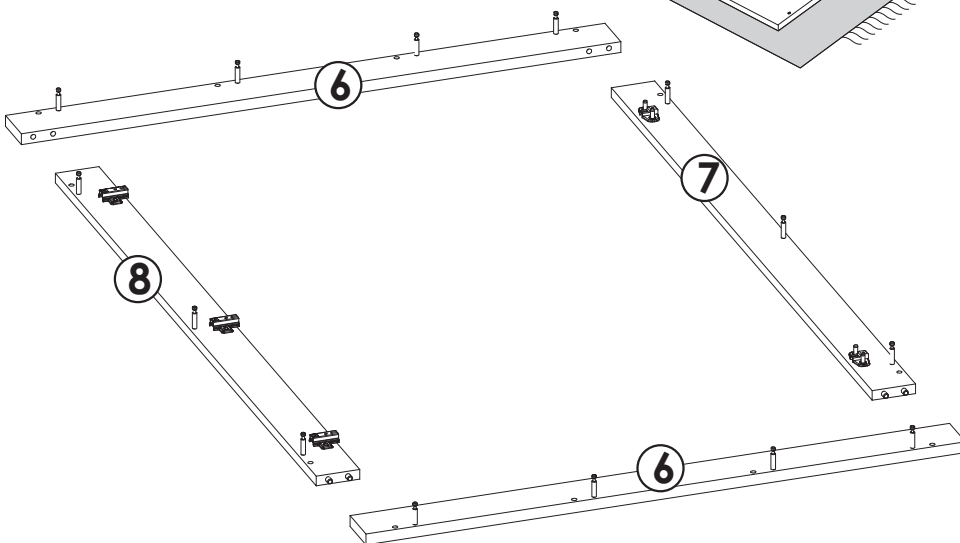
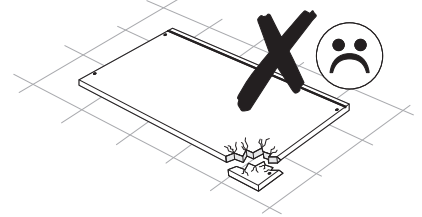
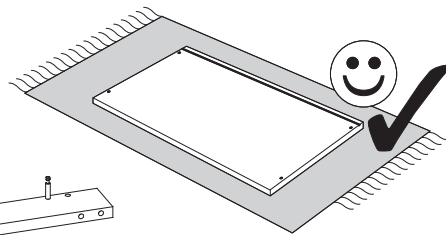

6

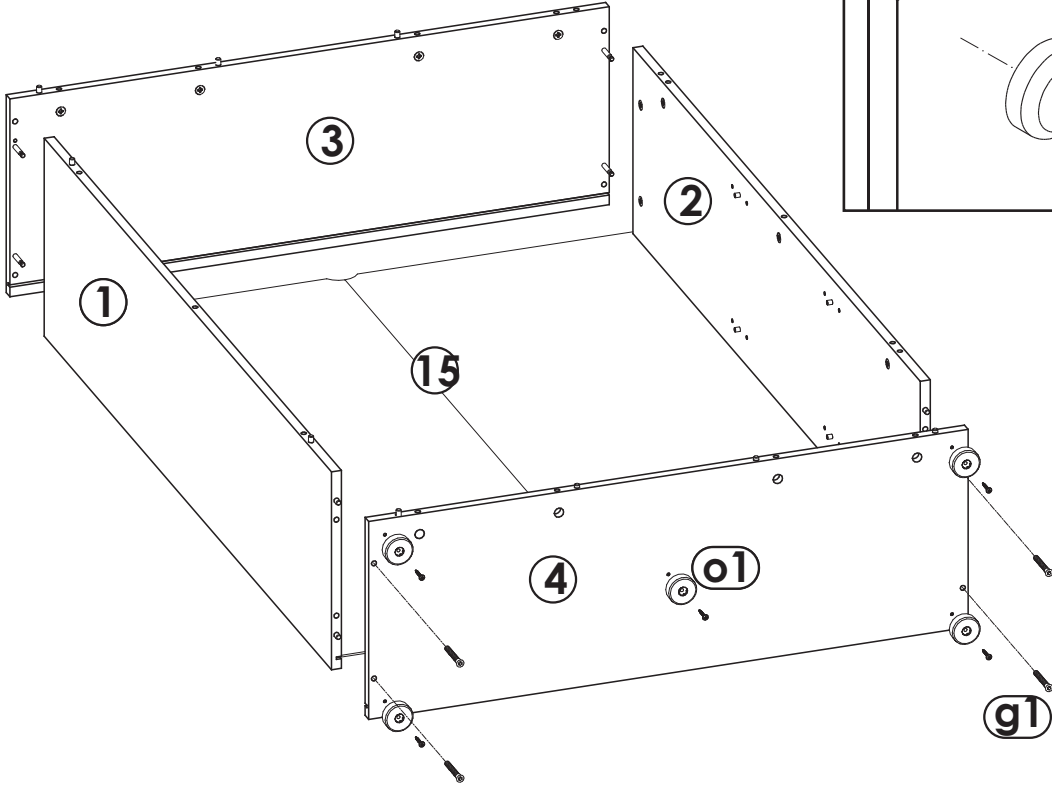
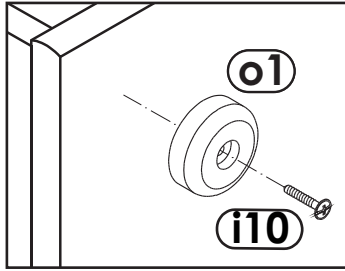
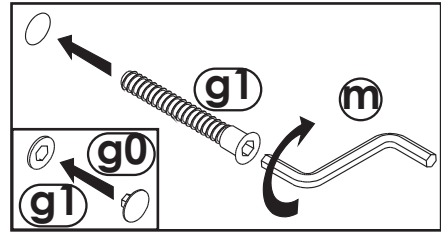
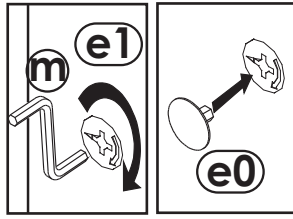
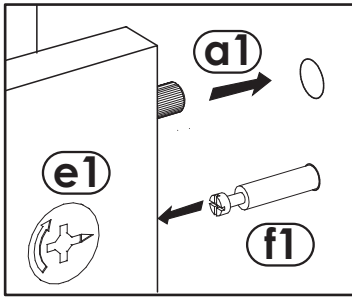

7

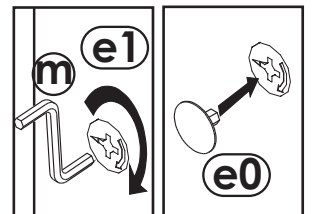
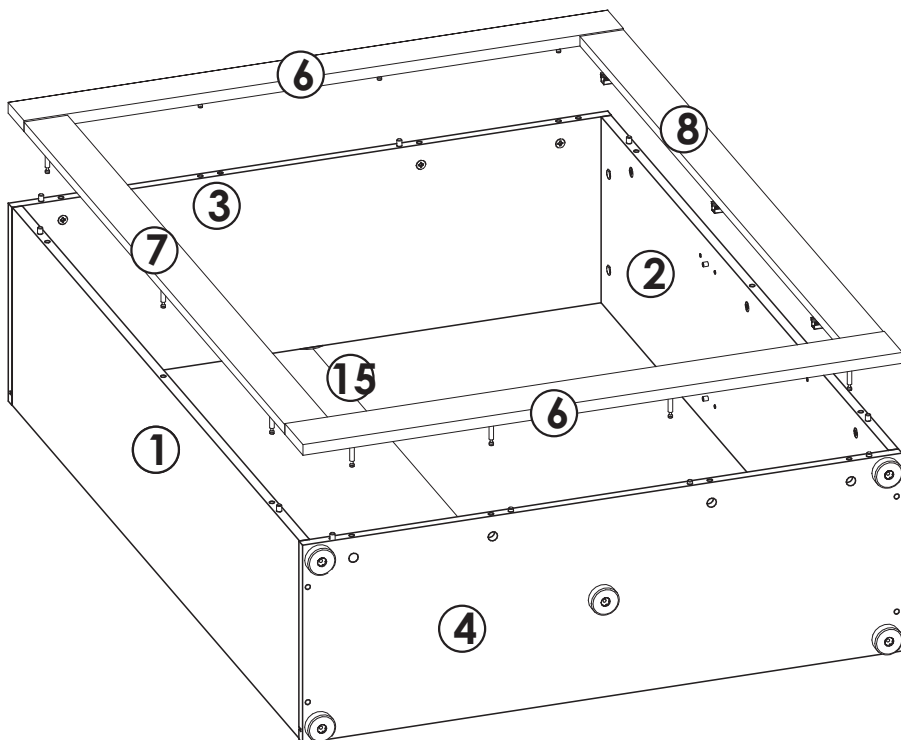

8

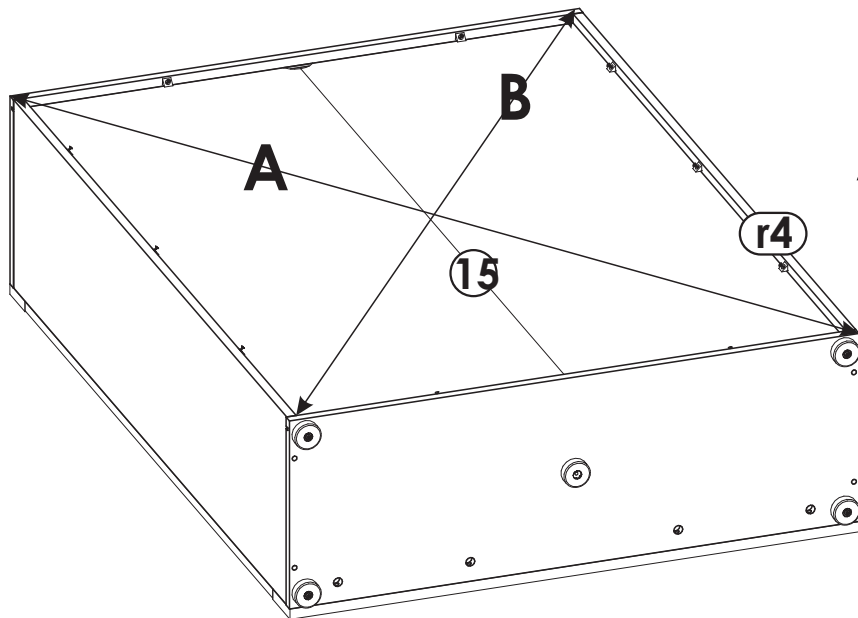

A=B

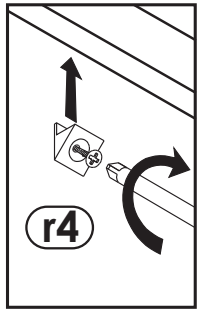

9

