

4

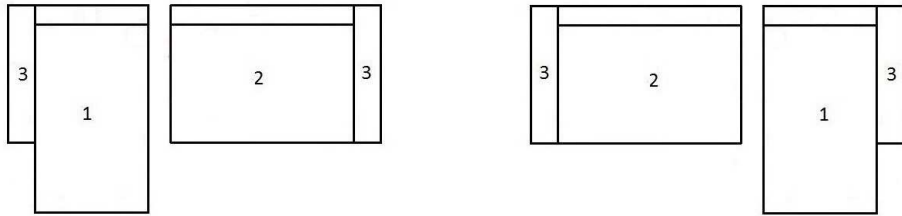

5

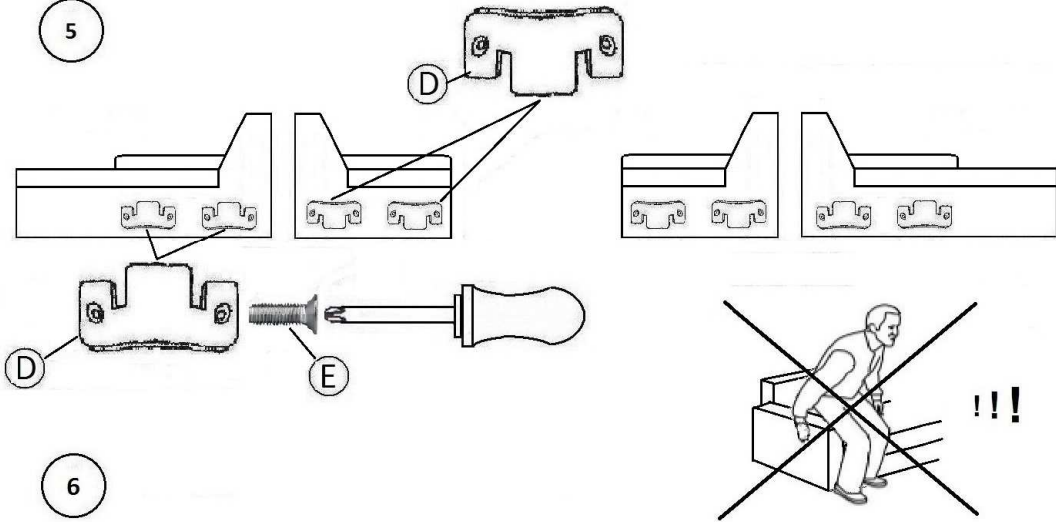

6

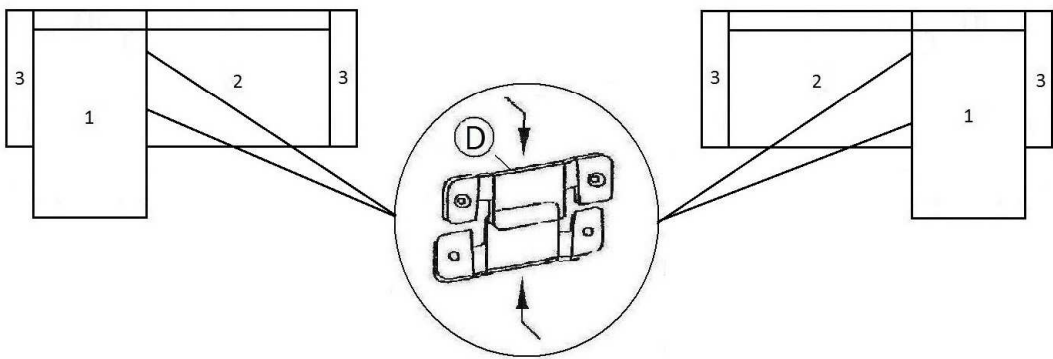

- 1 - 156 x 86 x 87 x 1
- 2 - 112 x 86 x 94 x 1
- 3 - 92 x 24 x 68 x 2



60 min

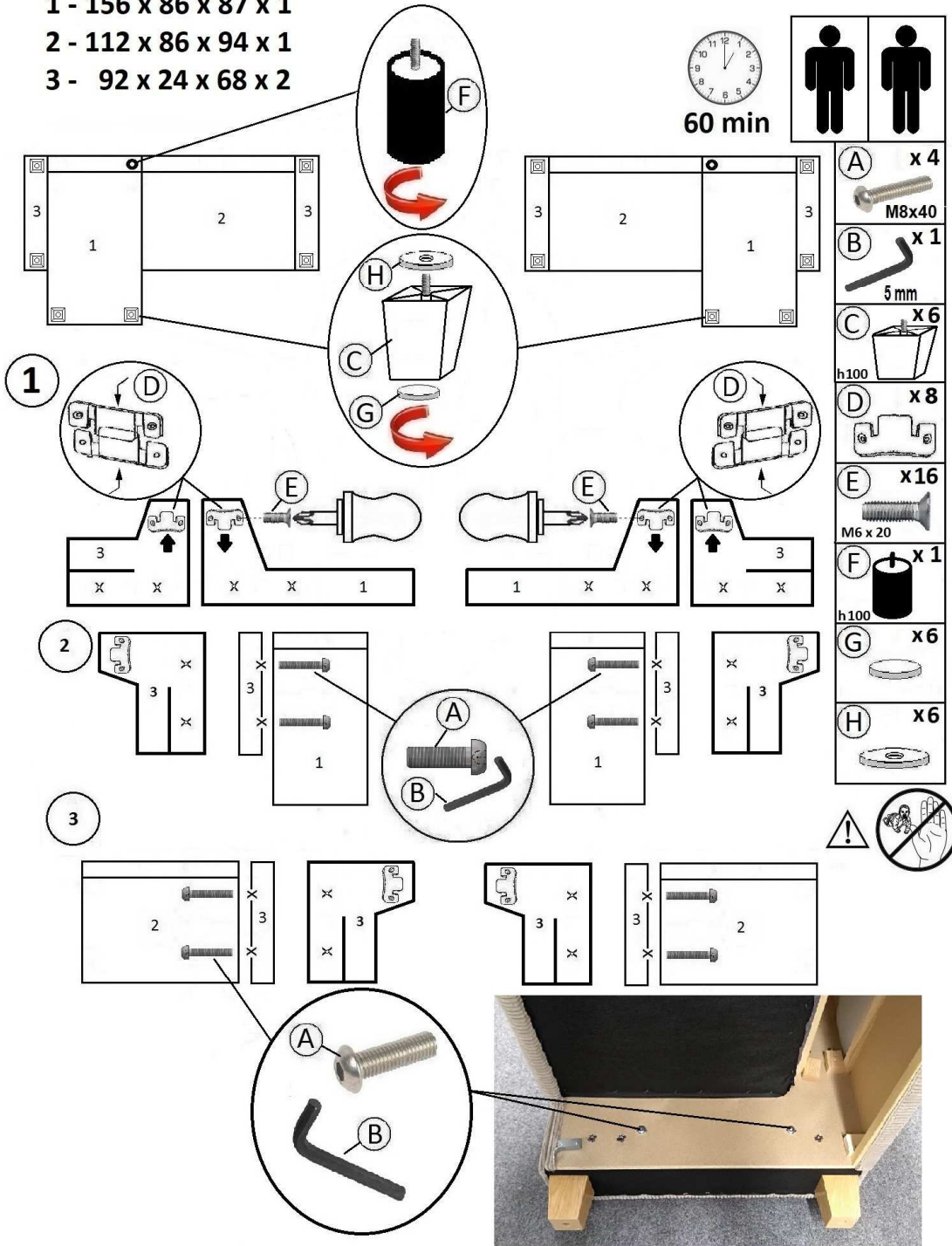
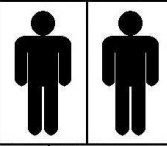

- (A) x 4
M8x40
- (B) x 1
5 mm
- (C) x 6
h100
- (D) x 8
- (E) x 16
M6 x 20
- (F) x 1
h100
- (G) x 6
- (H) x 6



1

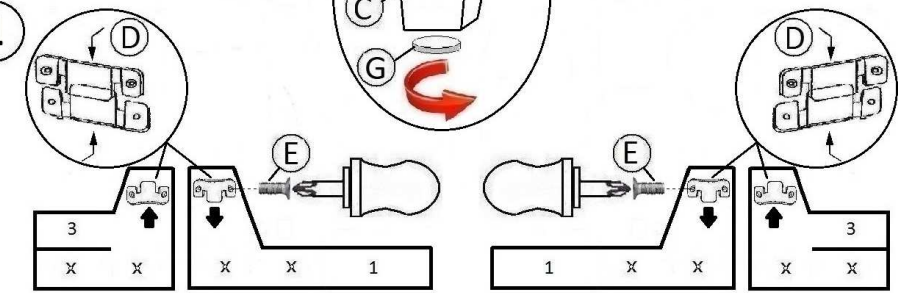

2

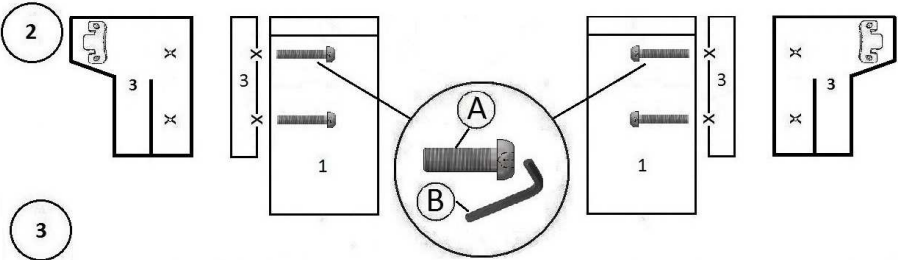

3

