

2018-11-08

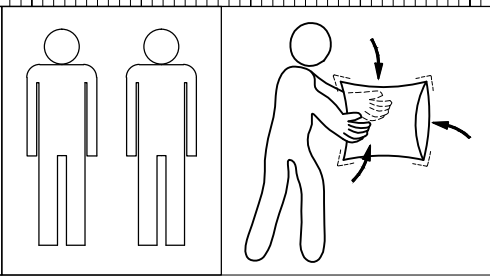

30min.

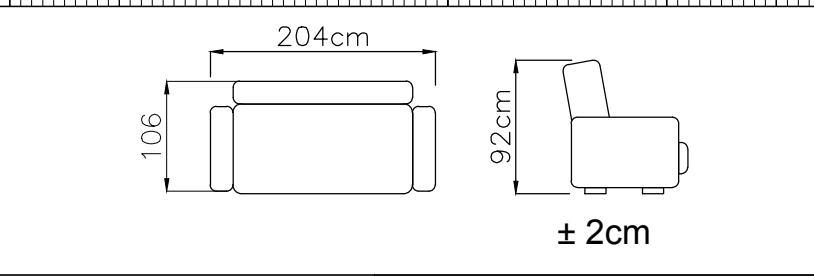

Belavio 2

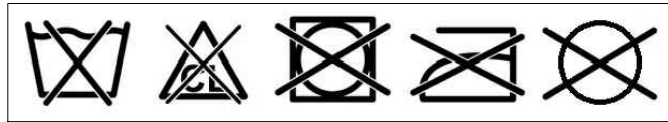
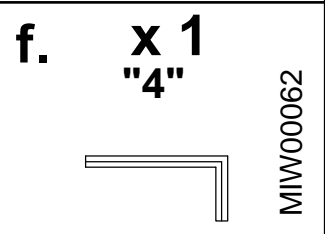
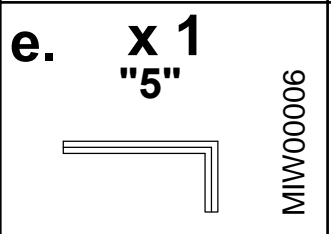
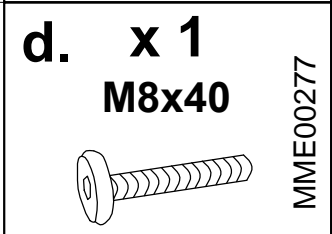
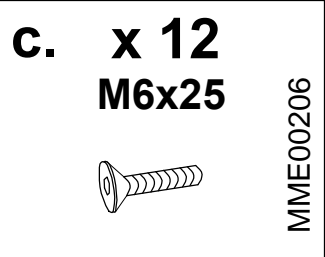
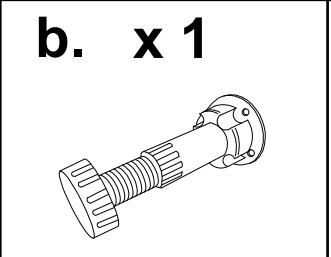
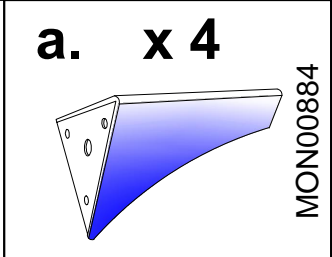
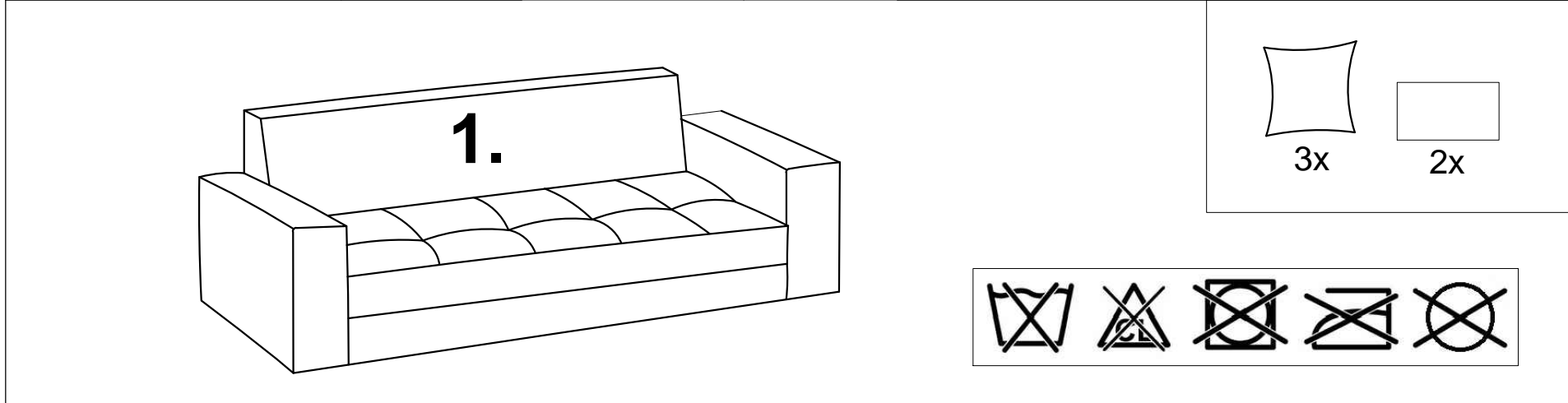

I	a. x 4	b. x 1
	c. x 12 M6x25	d. x 1 M8x40
	f. x 1 "4"	e. x 1 "5"

