

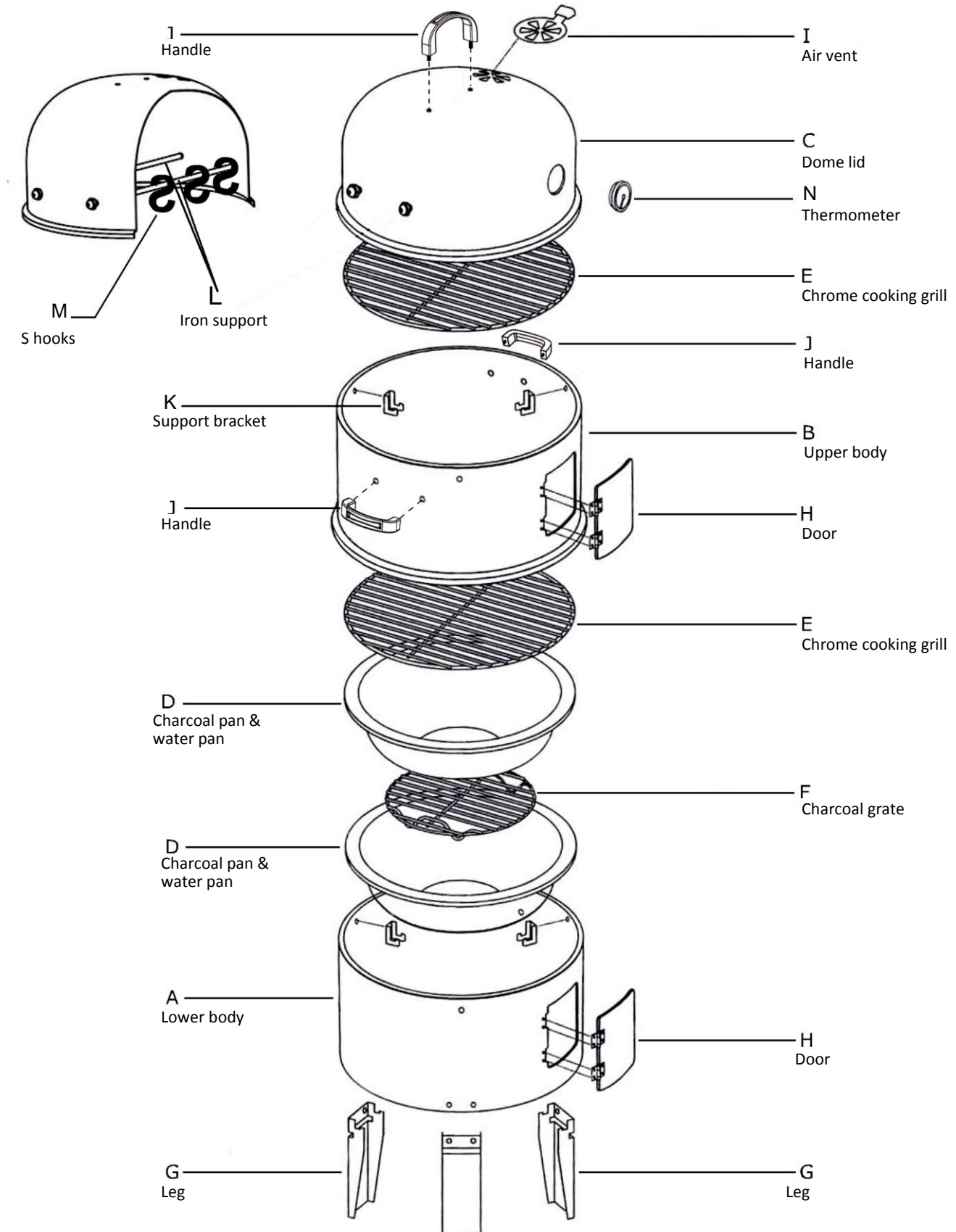

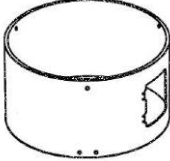

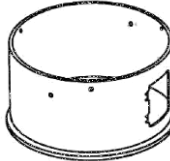

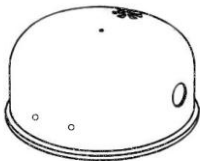

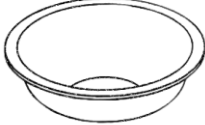

[UK] MANUAL





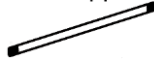



Exploded Diagram



Parts List

<p>A</p>  <p>Lower Body x 1</p>	<p>B</p>  <p>Upper Body x 1</p>	<p>C</p>  <p>Dome Lid x 1</p>
<p>D</p>  <p>Charcoal Pan and Water Pan x 2</p>	<p>E</p>  <p>Chrome Cooking Grill x 2</p>	<p>F</p>  <p>Charcoal Grate x 1</p>
<p>G</p>  <p>Leg x 3</p>	<p>H</p>  <p>Door x 2</p>	<p>I</p>  <p>Air Vent x 1</p>
<p>J</p>  <p>Handle x 3</p>	<p>K</p>  <p>Support Bracket x 6</p>	<p>L</p>  <p>Iron Support x 2</p>
<p>M</p> <p>S</p> <p>S Hook x 3</p>	<p>N</p>  <p>Thermometer x 1</p>	

Hardware

 <p>AA x 6</p>	 <p>BB x 7</p>	 <p>CC x 8</p>	 <p>DD x 6</p>	 <p>EE x 12</p>
 <p>FF x 7</p>	 <p>GG x 8</p>	 <p>HH x 4</p>	 <p>II x 6</p>	

Assembly Instructions

Step 1

Attach three legs (G) to lower body (A) using six bolts (AA) & six nuts (EE), then attach door (H) to lower body (A) using four bolts (CC) & four nuts (GG).

Attach three support brackets (K) to lower body (A) using three bolts (BB) & three nuts (FF).

Place charcoal grate (F) inside the charcoal pan (D).

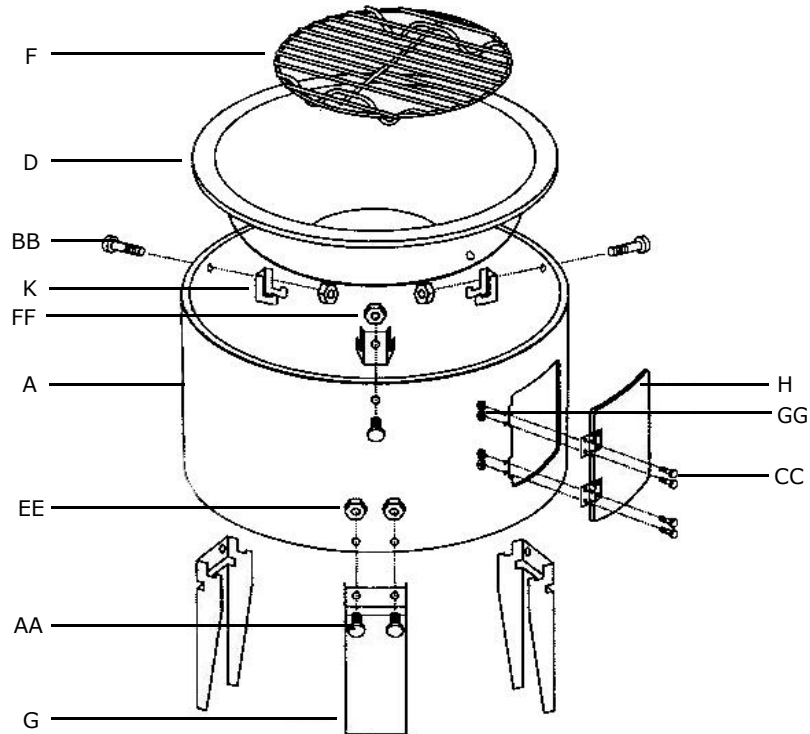

Step 2

Attach door (H) to upper body (B) using four bolts (CC) and four nuts (GG).

Attach three support brackets (K) to upper body (B) using three bolts (BB) & three nuts (FF).

Attach two handles (J) on upper body (B) using four heat-resistant plates (II), four washers (DD) and four nuts (EE).

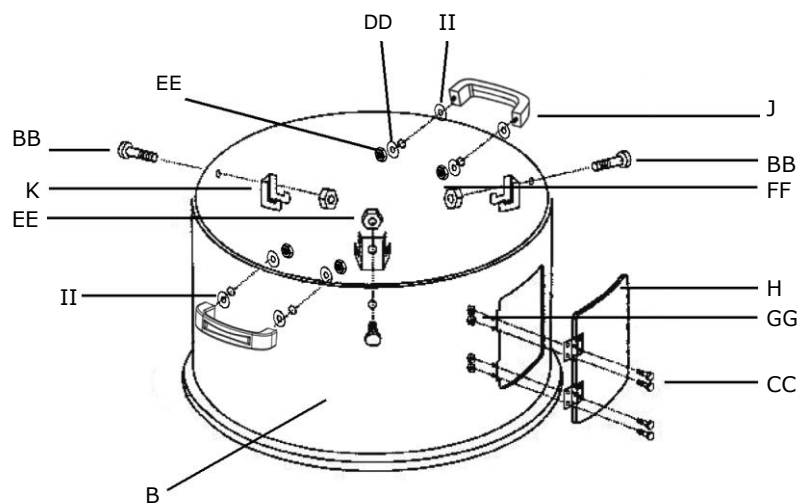

Step 3

Attach handle (J) to dome lid (C) using two heat resistant plates (II), two washers (DD) and two nuts (EE). Attach air vent (I) to lid (C) using one bolt (BB) and one nut (FF). Attach two iron supports (L) to dome lid (C) using four nuts (HH).

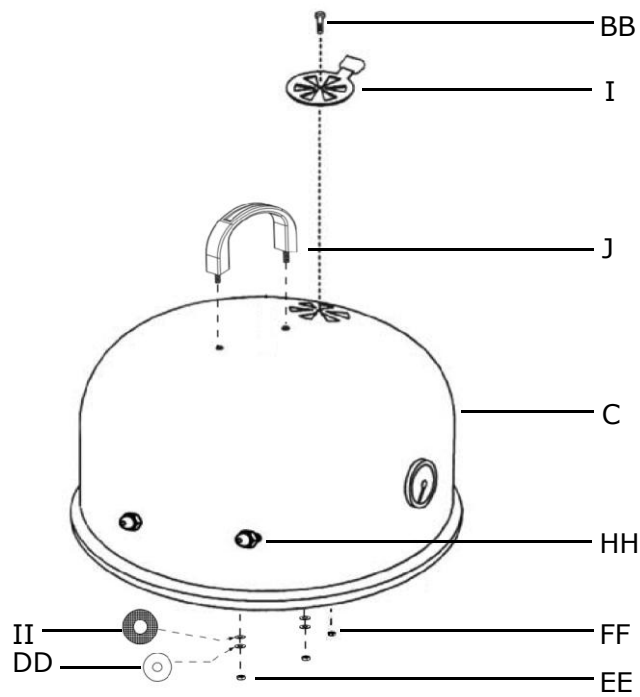

Step 4

Stack the parts as shown below.

Final appearance of assembled charcoal smoker.

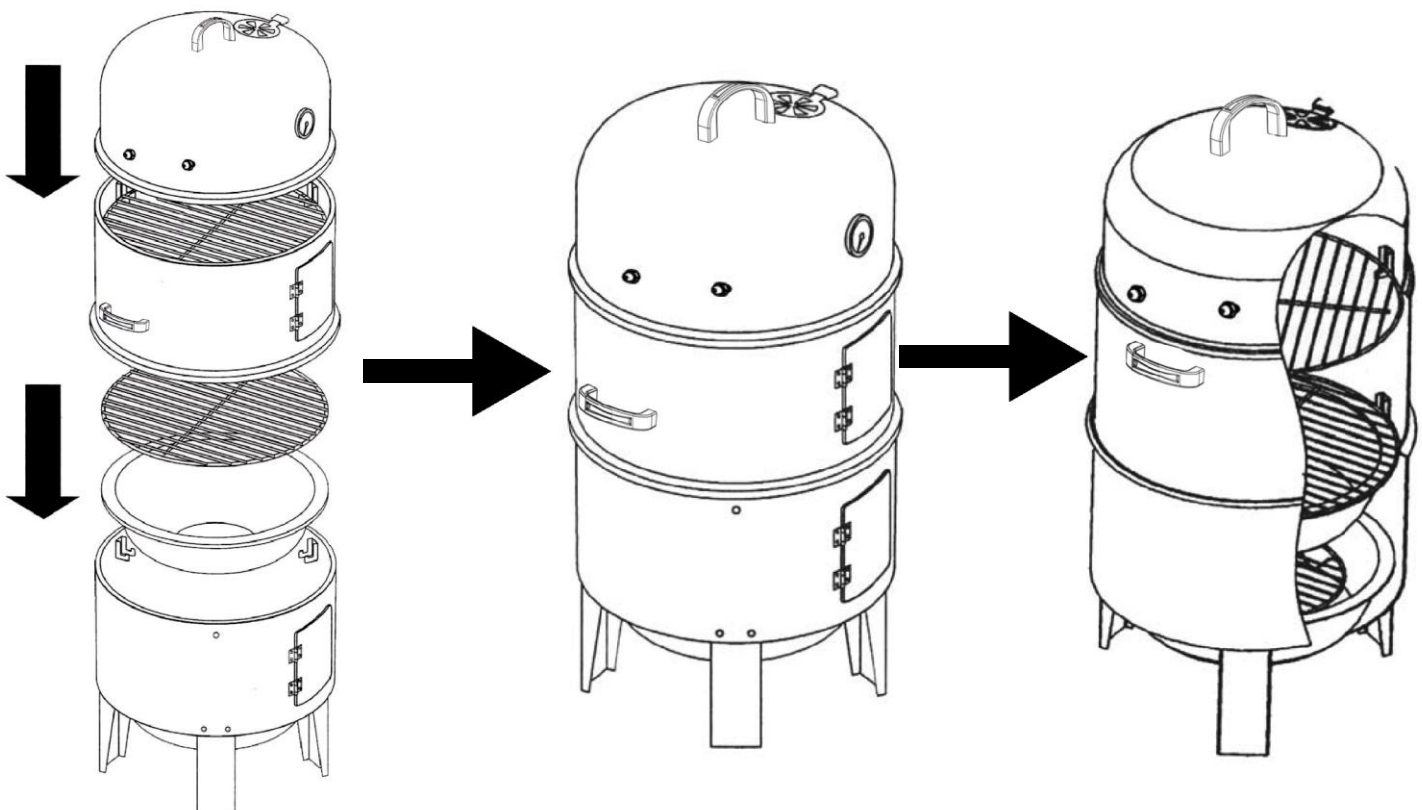





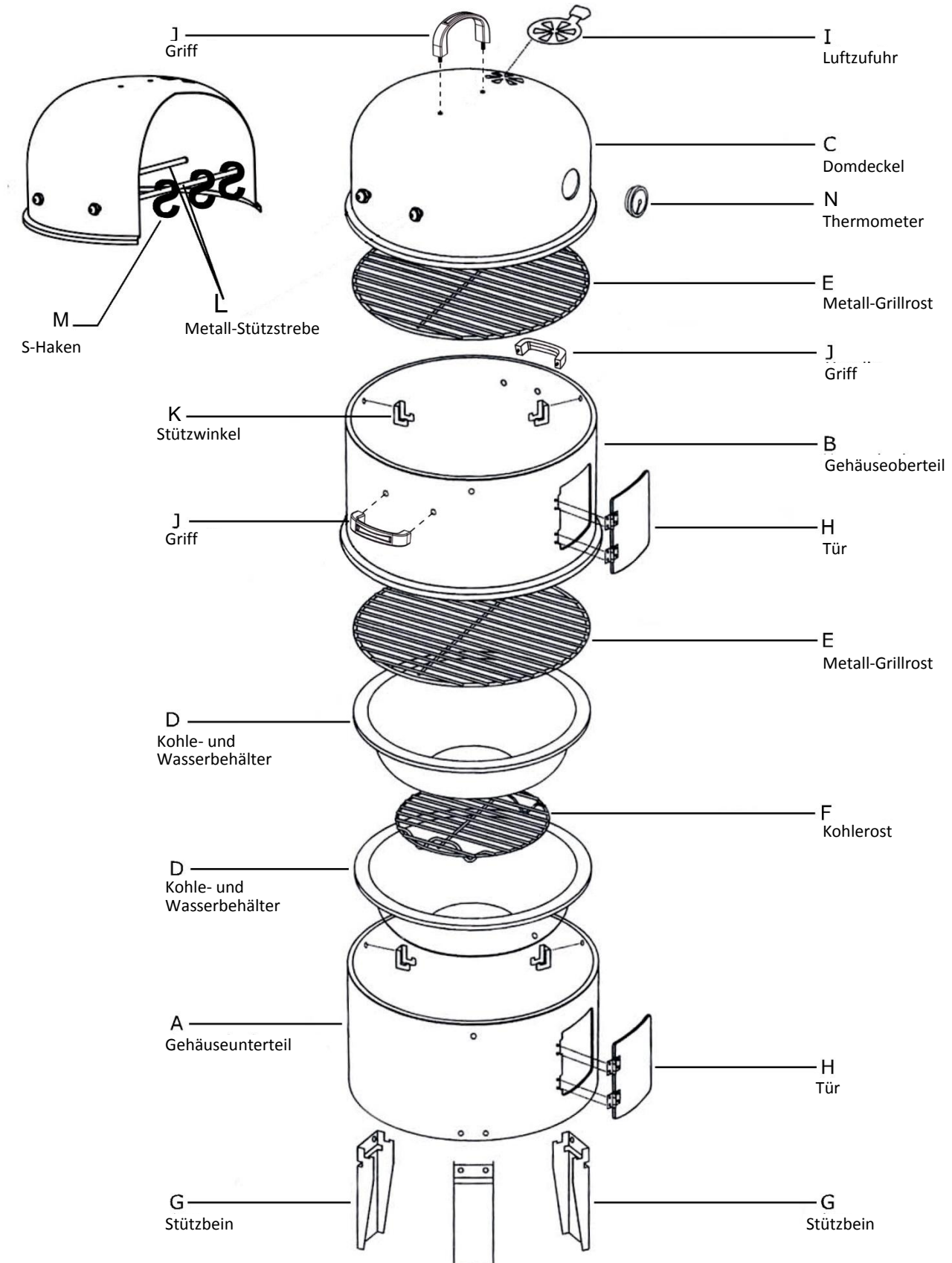

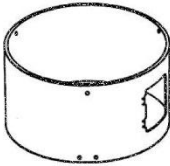
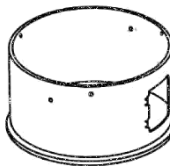
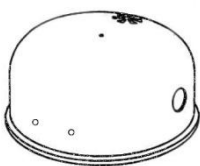
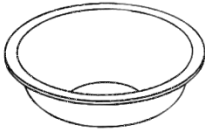
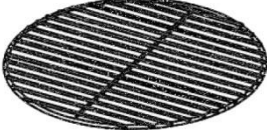

[DE] BEDIENUNGS- ANLEITUNG





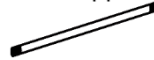



Explosionsdarstellung



Teilleiste

<p>A</p>  <p>Gehäuseunterteil x 1</p>	<p>B</p>  <p>Gehäuseoberteil x 1</p>	<p>C</p>  <p>Domdeckel x 1</p>
<p>D</p>  <p>Kohle- und Wasserbehälter x 2</p>	<p>E</p>  <p>Metall-Grillrost x 2</p>	<p>F</p>  <p>Kohlerost x 1</p>
<p>G</p>  <p>Stützbein x 3</p>	<p>H</p>  <p>Tür x 2</p>	<p>I</p>  <p>Luftzufuhr x 1</p>
<p>J</p>  <p>Griff x 3</p>	<p>K</p>  <p>Stützwinkel x 6</p>	<p>L</p>  <p>Metall-Stützstrebe x 2</p>
<p>M</p> <p>S</p>  <p>S-Haken x 3</p>	<p>N</p>  <p>Thermometer x 1</p>	

Hardware

 <p>AA x 6</p>	 <p>BB x 7</p>	 <p>CC x 8</p>	 <p>DD x 6</p>	 <p>EE x 12</p>
 <p>FF x 7</p>	 <p>GG x 8</p>	 <p>HH x 4</p>	 <p>II x 6</p>	

Montageanweisungen

Schritt 1

Befestigen Sie die drei Stützbeine (G) mit sechs Schrauben (AA) und sechs Muttern (EE) am Gehäuseunterteil (A) an. Befestigen Sie dann die Tür (H) mit vier Schrauben (CC) und vier Muttern (GG) am Gehäuseunterteil (A).

Befestigen Sie drei Stützwinkel (K) mit drei Schrauben (BB) und drei Muttern (FF) am Gehäuseunterteil (A). Setzen Sie den Kohlerost (F) in den Kohlebehälter (D) ein.

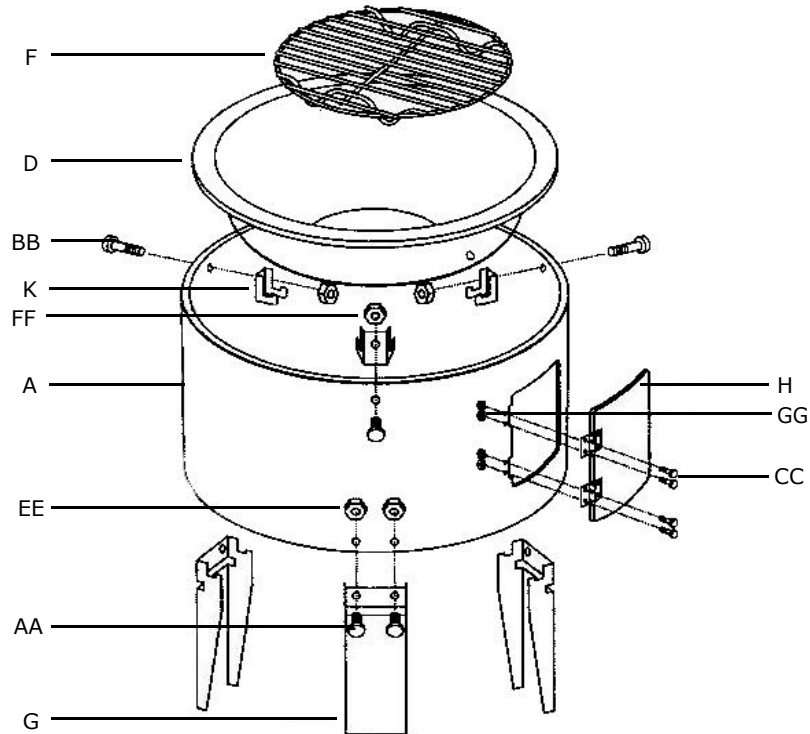

Schritt 2

Befestigen Sie die Tür (H) mit vier Schrauben (CC) und vier Muttern (GG) am Gehäuseoberteil (B).

Befestigen Sie drei Stützwinkel (K) mit drei Schrauben (BB) und drei Muttern (FF) am Gehäuseoberteil (B).

Befestigen Sie die beiden Griffe (J) unter Verwendung vier hitzebeständiger Platten (II) mit vier Unterlegscheiben (DD) und vier Muttern (EE) am Gehäuseoberteil (B).

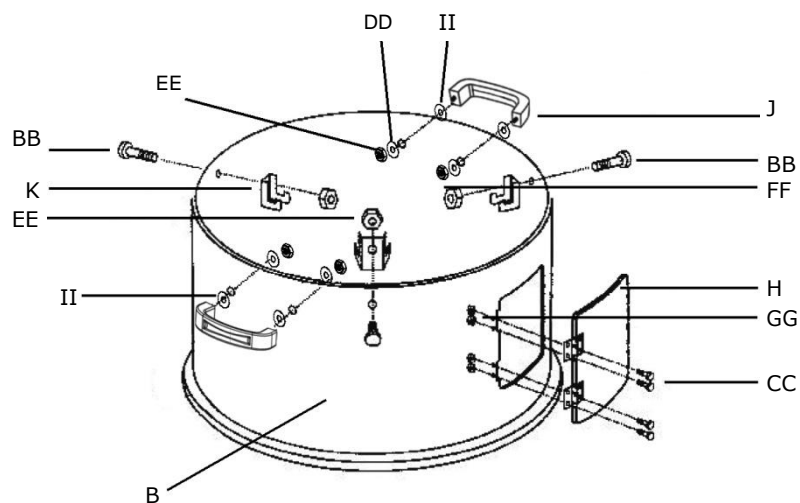

Schritt 3

Befestigen Sie den Griff (J) unter Verwendung zwei hitzebeständiger Platten (II) mit zwei Unterlegscheiben (DD) und zwei Muttern (EE) am Domdeckel (C).

Befestigen Sie die Luftzufuhr (I) mit einer Schraube (BB) und einer Mutter (FF) am Domdeckel (C). Befestigen Sie die zwei Metall-Stützstreben (L) mit vier Muttern (HH) am Domdeckel (C).

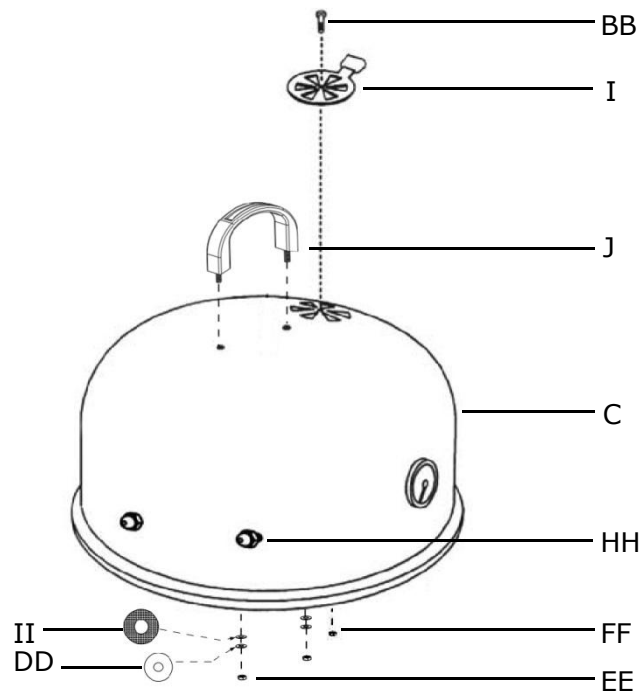

Schritt 4

Stapeln Sie die Teile wie unten dargestellt übereinander.

Fertig montierter Holzkohle-Räucherofen.

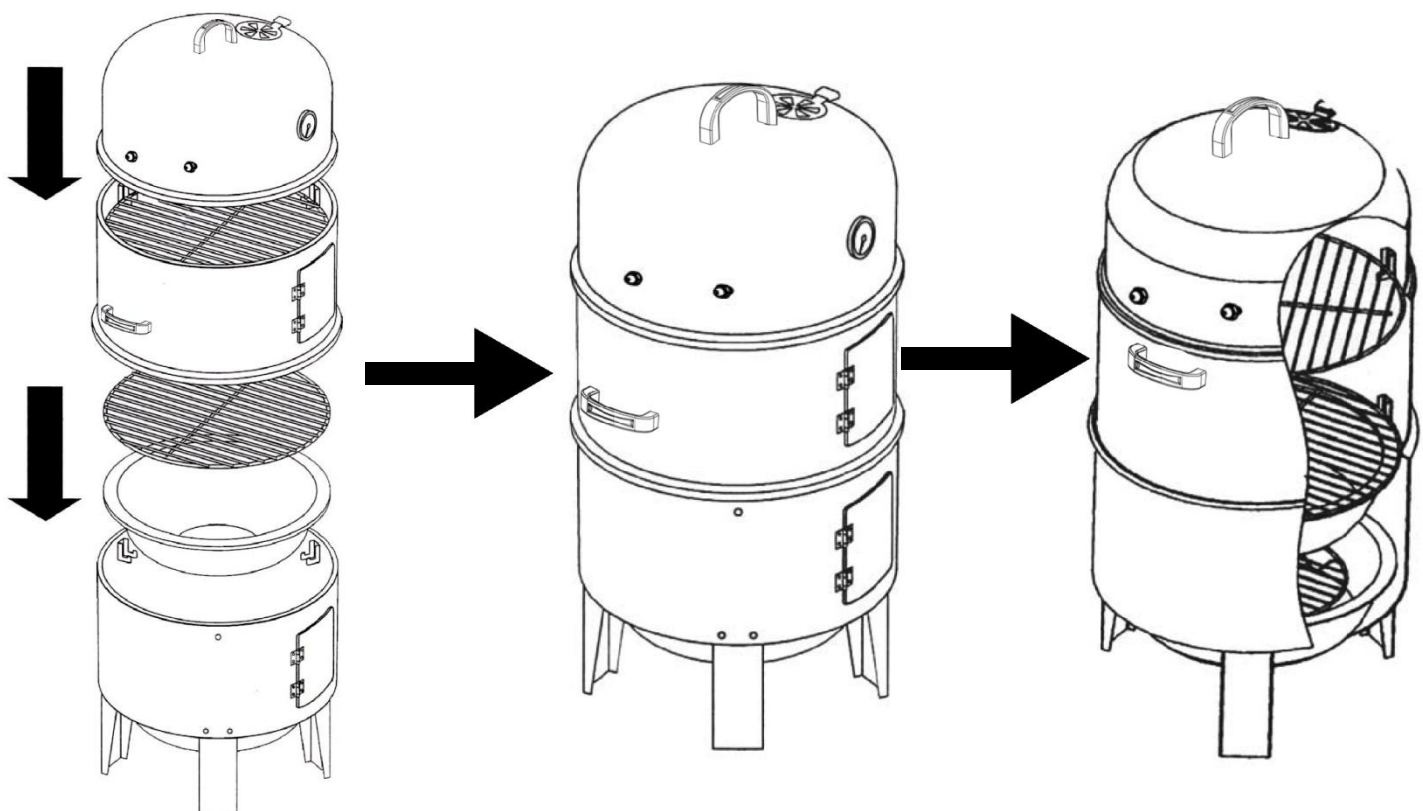





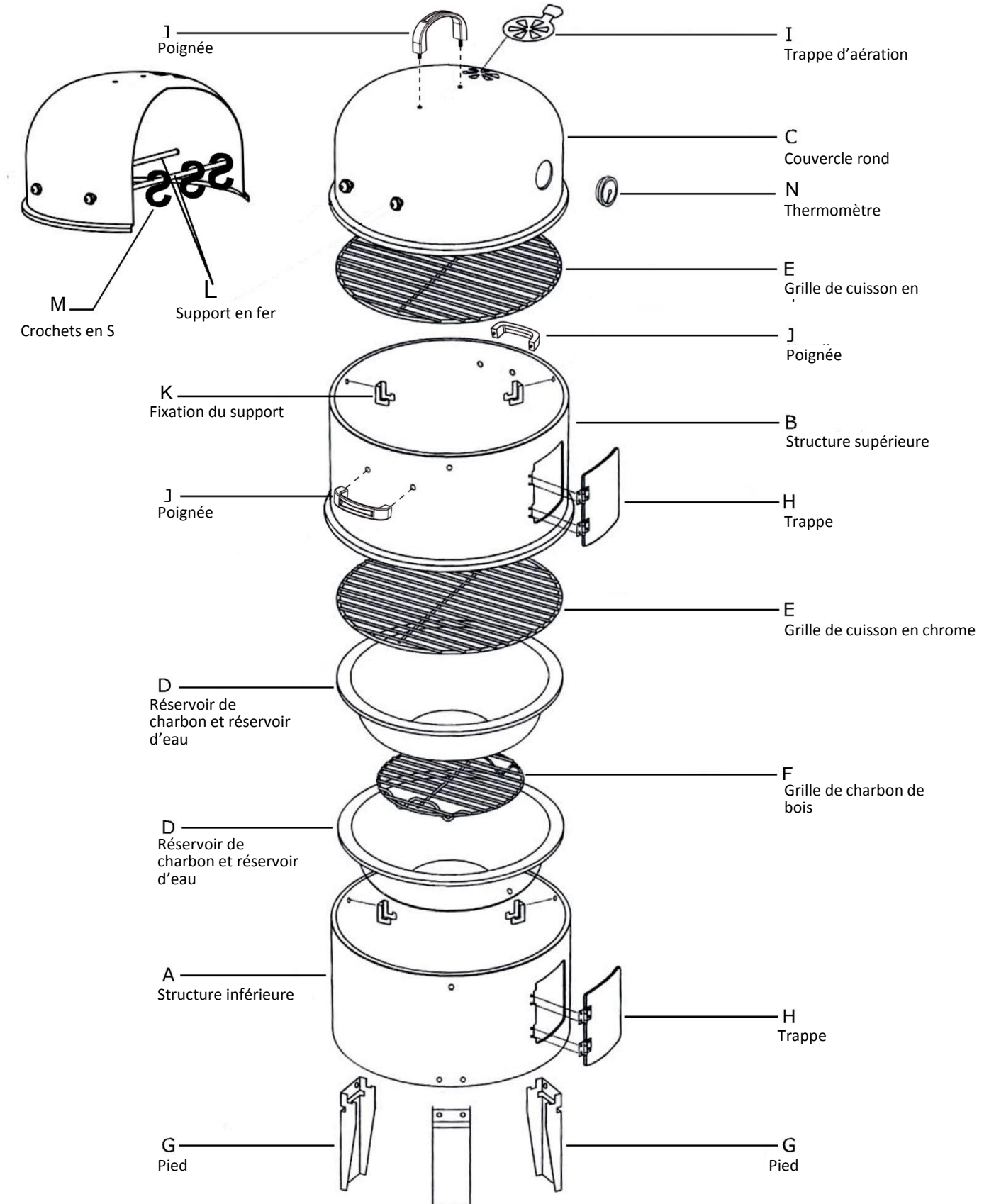

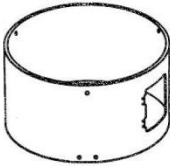
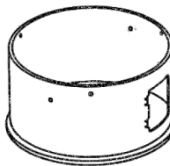
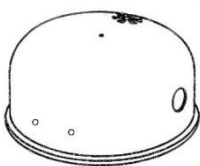
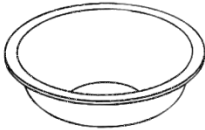
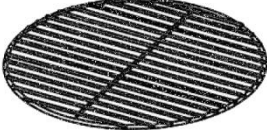

[FR] MANUEL





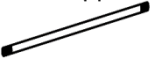



Vue éclatée

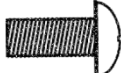

Liste des pièces

<p>A</p>  <p>Structure inférieure x 1</p>	<p>B</p>  <p>Structure supérieure x 1</p>	<p>C</p>  <p>Couvercle rond x 1</p>
<p>D</p>  <p>Réservoir de charbon et réservoir d'eau x 2</p>	<p>E</p>  <p>Grille de cuisson en chrome x 2</p>	<p>F</p>  <p>Grille de charbon de bois x 1</p>
<p>G</p>  <p>Pied x 3</p>	<p>H</p>  <p>Trappe x 2</p>	<p>I</p>  <p>Trappe d'aération x 1</p>
<p>J</p>  <p>Poignée x 3</p>	<p>K</p>  <p>Fixation du support x 6</p>	<p>L</p>  <p>Support en fer x 2</p>
<p>M</p> <p>S</p> <p>Crochet en S x 3</p>	<p>N</p>  <p>Thermomètre x 1</p>	

Fixations

 <p>AA x 6</p>	 <p>BB x 7</p>	 <p>CC x 8</p>	 <p>DD x 6</p>	 <p>EE x 12</p>
 <p>FF x 7</p>	 <p>GG x 8</p>	 <p>HH x 4</p>	 <p>II x 6</p>	

Instructions de montage

Étape 1

Fixez trois pieds (G) sur la structure inférieure (A) en utilisant six vis (AA) et six écrous (EE), puis fixez la trappe (H) sur la structure inférieure (A) en utilisant quatre vis (CC) et quatre écrous (GG).

Fixez trois fixations de support (K) sur la structure inférieure (A) en utilisant trois vis (BB) et trois boulons (FF). Placez la grille de charbon de bois (F) dans le réservoir de charbon (D).

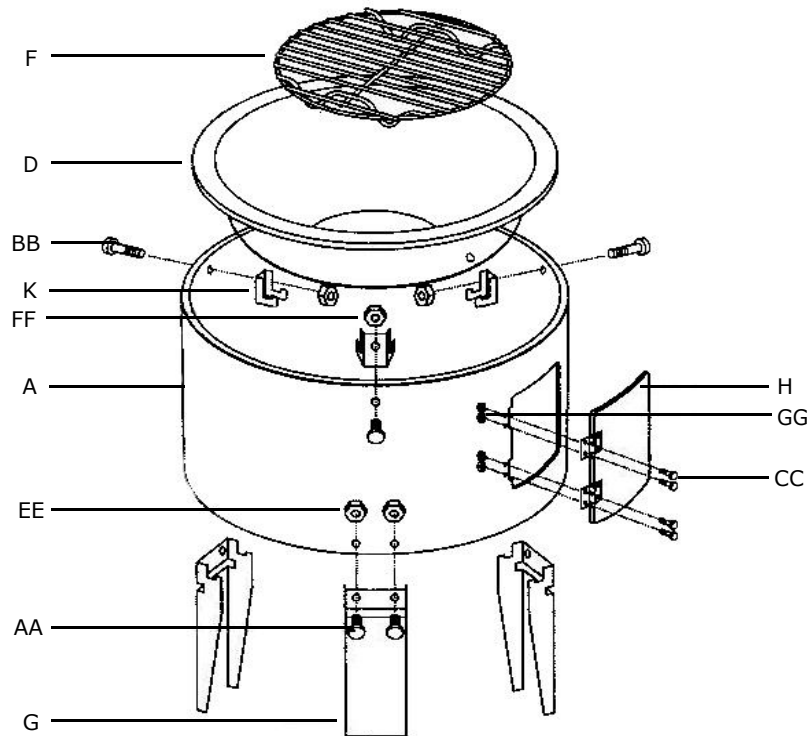

Étape 2

Fixez la trappe (H) sur la structure supérieure (B) en utilisant quatre vis (CC) et quatre écrous (GG).

Fixez trois fixations de support (K) sur la structure supérieure (B) en utilisant trois vis (BB) et trois boulons (FF).

Fixez deux poignées (J) sur la structure supérieure (B) en utilisant quatre rondelles résistantes à la chaleur (II), quatre rondelles (DD) et quatre écrous (EE).

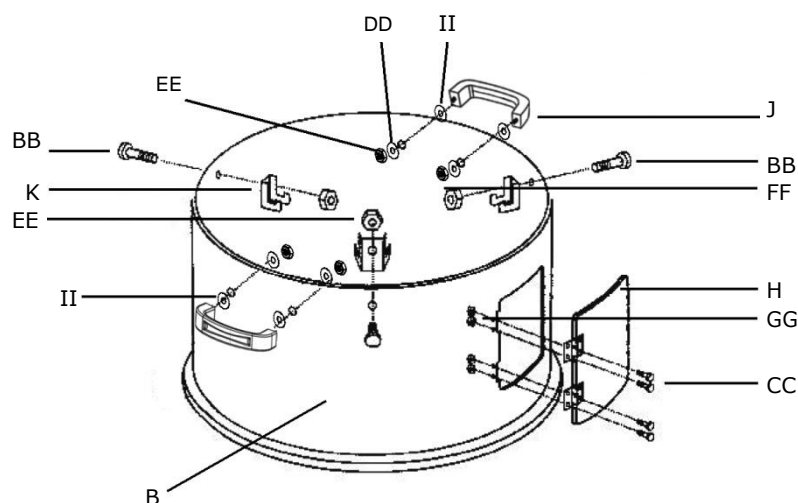

Étape 3

Fixez la poignée (J) sur le couvercle rond (C) en utilisant deux rondelles résistantes à la chaleur (II), deux rondelles (DD) et deux écrous (EE).

Fixez la trappe d'aération (I) sur le couvercle (C) en utilisant une vis (BB) et un écrou (FF). Fixez deux supports en fer (L) sur le couvercle rond (C) en utilisant quatre écrous (HH).

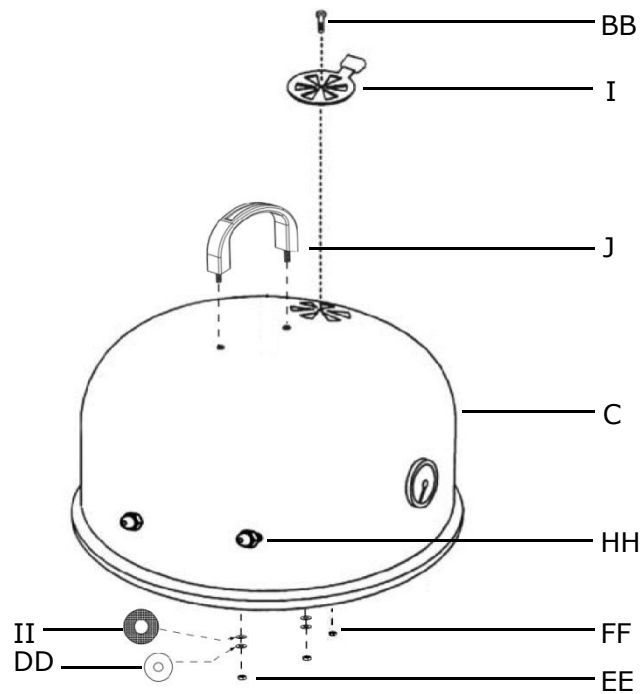

Étape 4

Empilez les différentes parties, comme illustré ci-dessous.

Aspect final du fumeur à charbon assemblé.

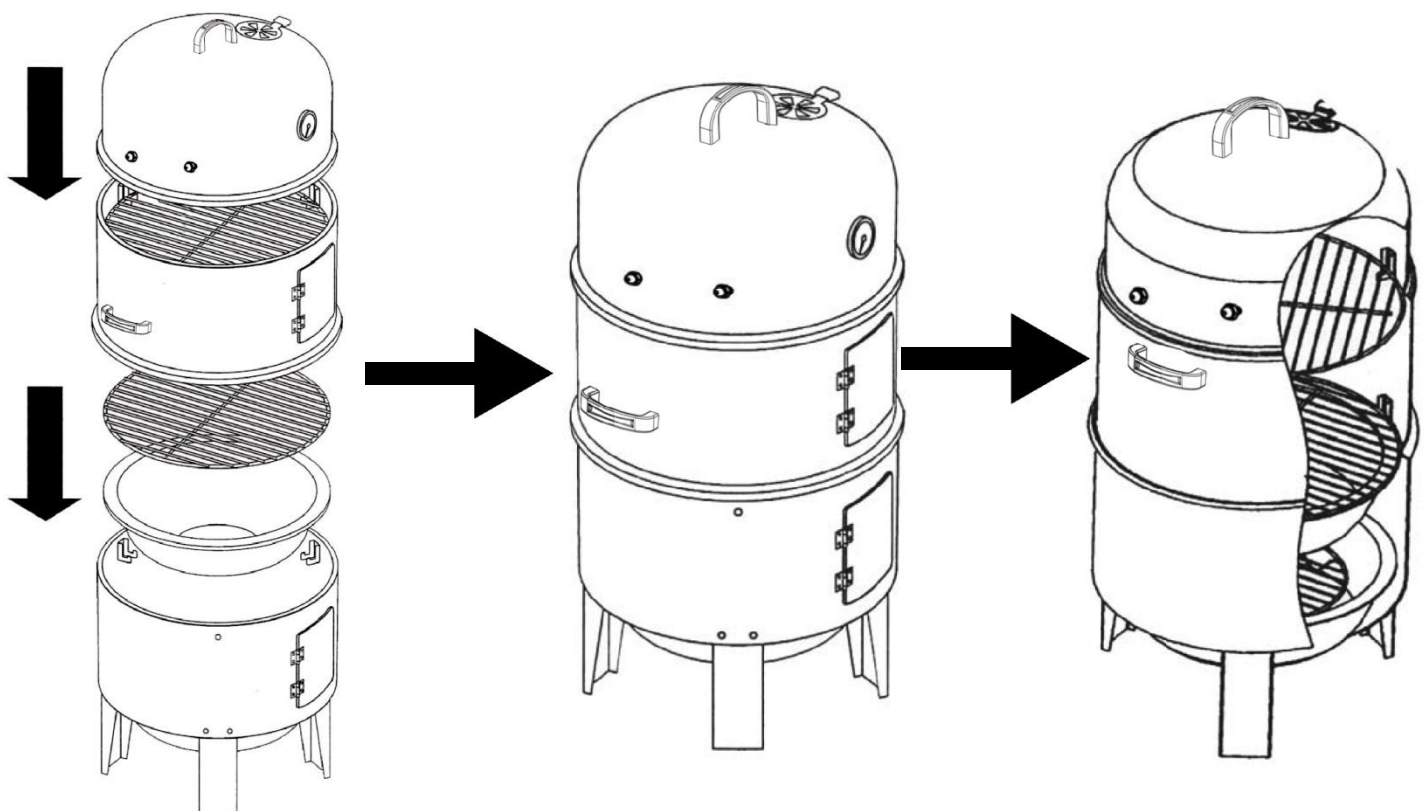





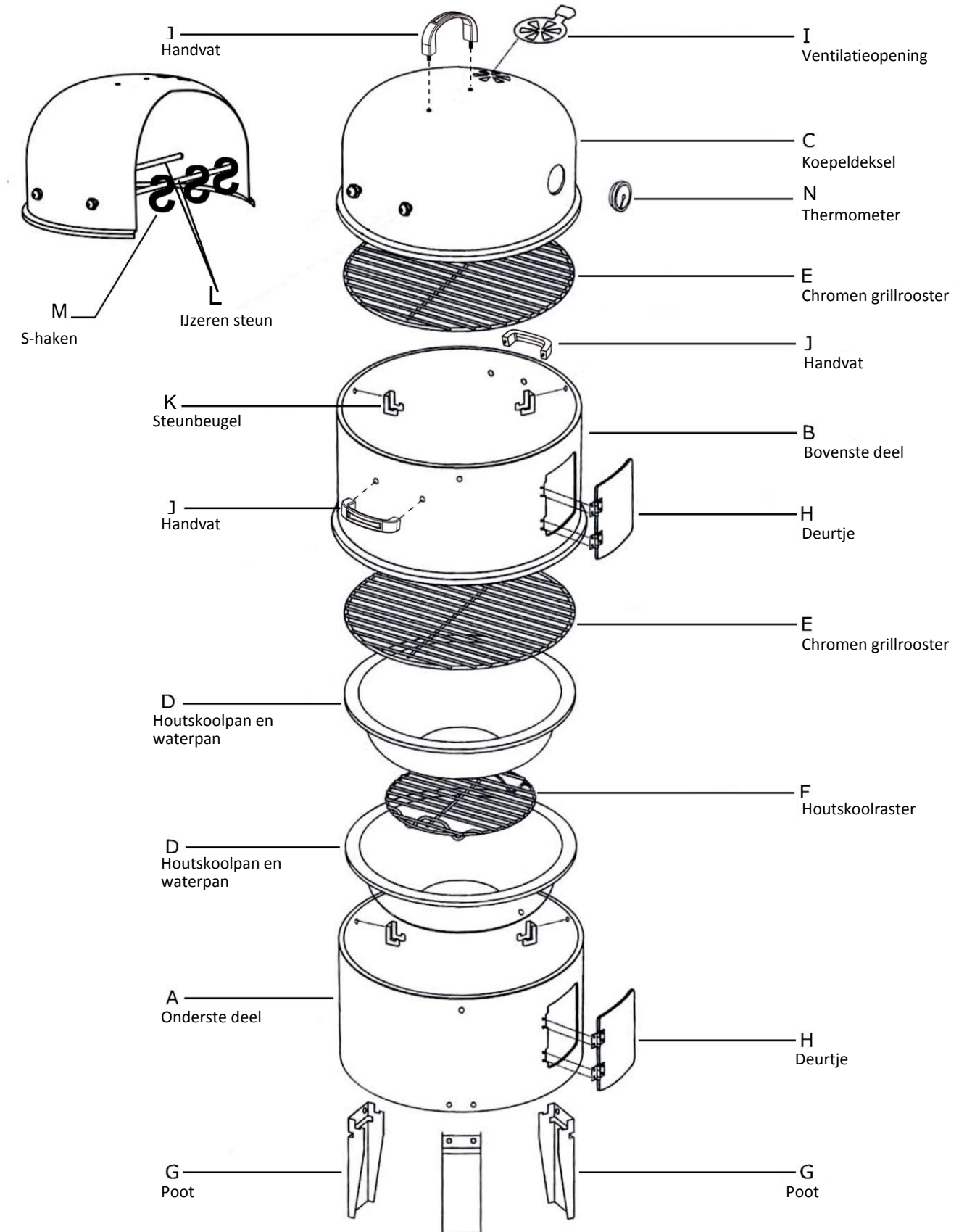



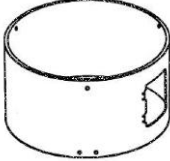
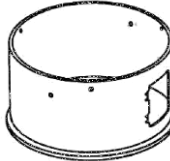
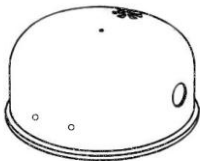
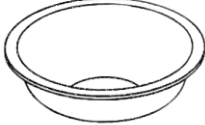

[NL] HANDLEIDING





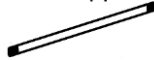



Opengewerkt diagram



Onderdelenlijst

<p>A</p>  <p>Onderste deel x 1</p>	<p>B</p>  <p>Bovenste deel x 1</p>	<p>C</p>  <p>Koepeldeksel x 1</p>
<p>D</p>  <p>Houtskoolpan en waterpan x 2</p>	<p>E</p>  <p>Chromen grillrooster x 2</p>	<p>F</p>  <p>Houtskoolraster x 1</p>
<p>G</p>  <p>Poot x 3</p>	<p>H</p>  <p>Deurtje x 2</p>	<p>I</p>  <p>Ventilatieopening x 1</p>
<p>J</p>  <p>Handvat x 3</p>	<p>K</p>  <p>Steunbeugel x 6</p>	<p>L</p>  <p>IJzeren steun x 2</p>
<p>M</p> <p>S</p> <p>S-haak x 3</p>	<p>N</p>  <p>Thermometer x 1</p>	

Hardware

 <p>AA x 6</p>	 <p>BB x 7</p>	 <p>CC x 8</p>	 <p>DD x 6</p>	 <p>EE x 12</p>
 <p>FF x 7</p>	 <p>GG x 8</p>	 <p>HH x 4</p>	 <p>II x 6</p>	

Montage-instructies

Stap 1

Bevestig drie poten (G) met zes bouten (AA) en zes moeren (EE) aan het onderste deel (A).
Bevestig daarna het deurtje (H) met vier bouten (CC) en vier moeren (GG) aan het onderste deel (A).

Bevestig drie steunbeugels (K) met drie bouten (BB) en drie moeren (FF) aan het onderste deel (A).
Plaats het houtskoolraster (F) in de houtskoolbak (D).

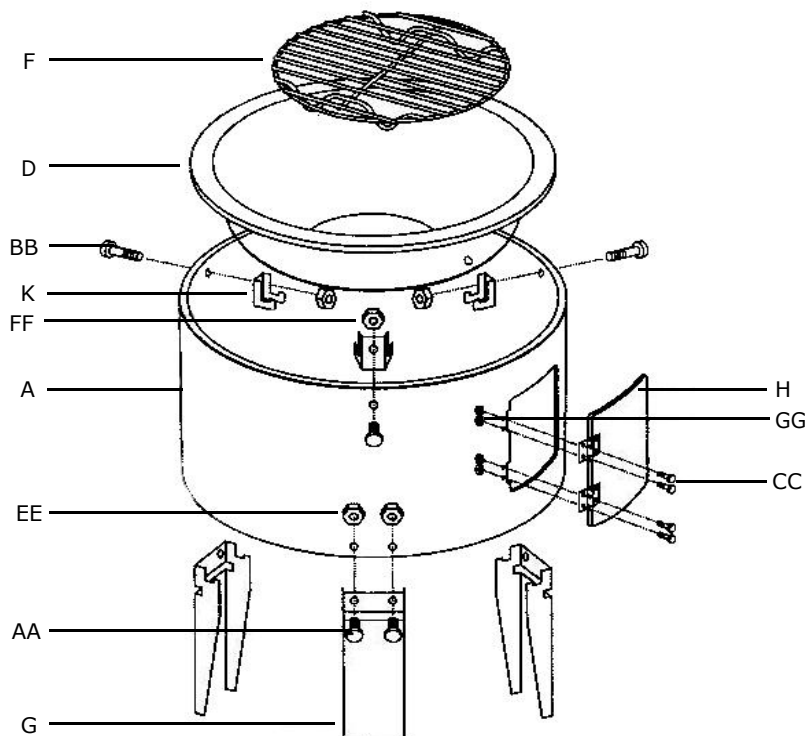

Stap 2

Bevestig het deurtje (H) met vier bouten (CC) en vier moeren (GG) aan het bovenste deel (B).

Bevestig drie steunbeugels (K) met drie bouten (BB) en drie moeren (FF) aan het bovenste deel (B).

Bevestig twee handvaten (J) met behulp van vier hittebestendige platen (II), vier sluitringen (DD) en vier moeren (EE) aan het bovenste deel (B).

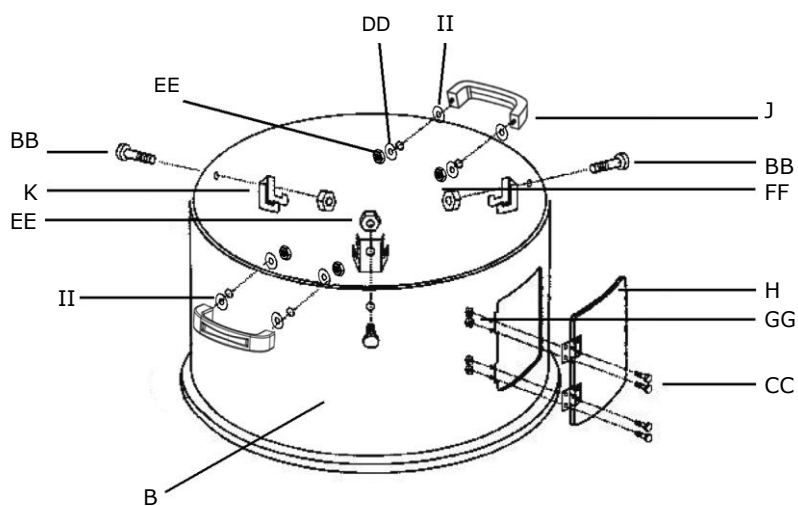

Stap 3

Bevestig het handvat (J) met behulp van twee hittebestendige platen (II), twee sluitringen (DD) en twee moeren (EE) aan het koepeldeksel (C).

Bevestig de ventilatieopening (I) met behulp van één bout (BB) en één moer (FF) aan het deksel (C).

Bevestig twee ijzeren steunen (L) met behulp van vier moeren (HH) aan het koepeldeksel (C).

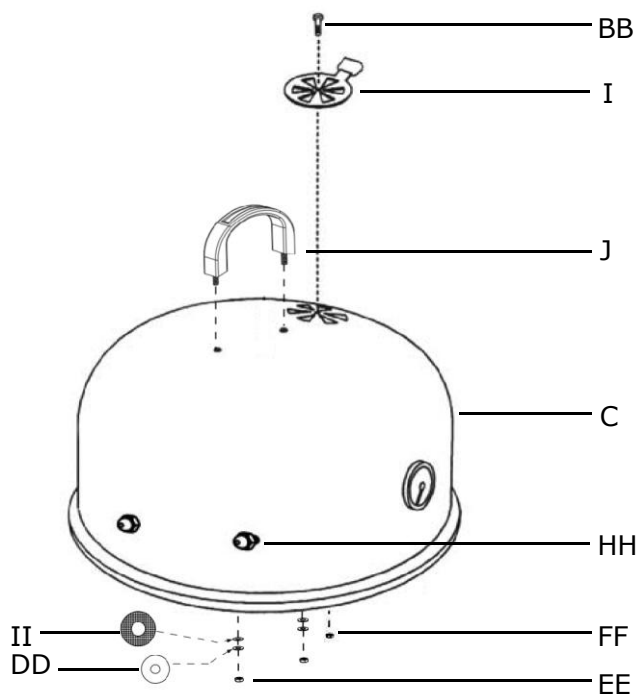

Stap 4

Stapel de onderdelen op elkaar (zie afbeelding).

Uiteindelijke uiterlijk van de gemonteerde houtskoolroker.

