

# 980757

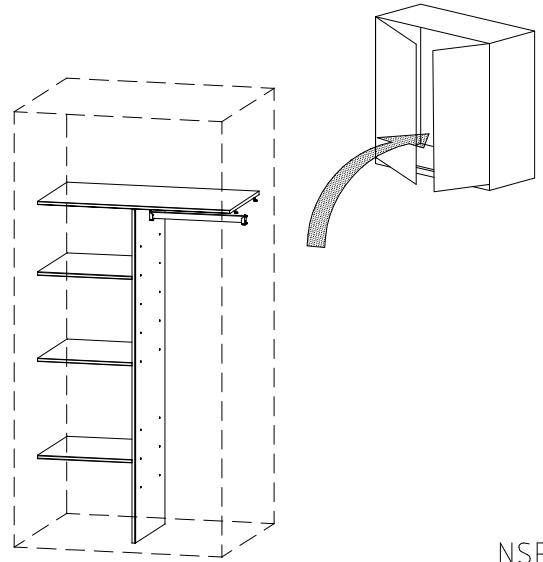

NSP 87

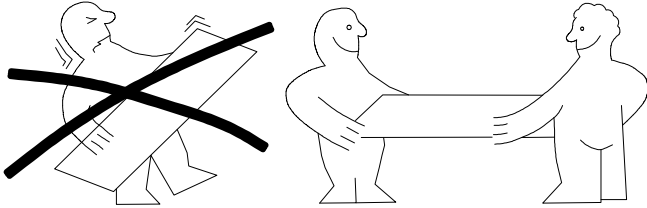
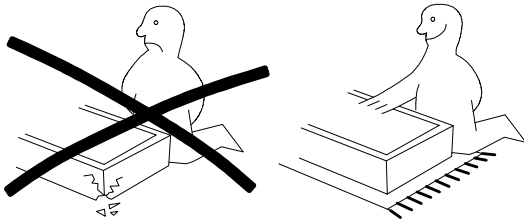
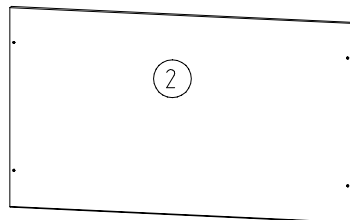
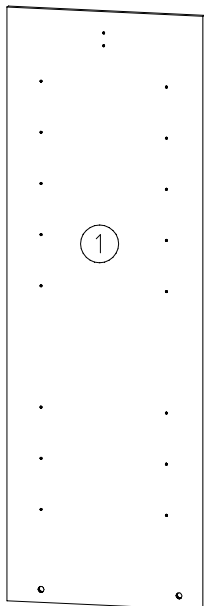
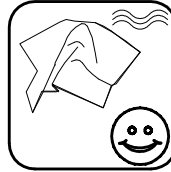
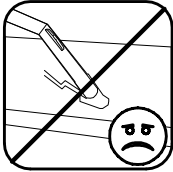
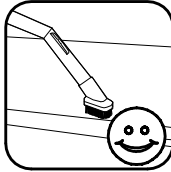
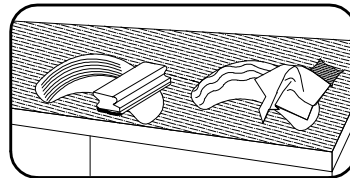
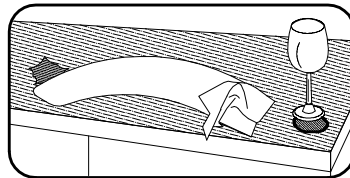
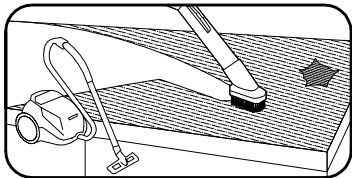
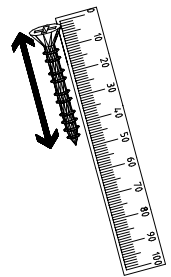
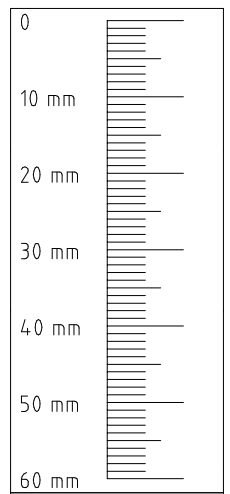
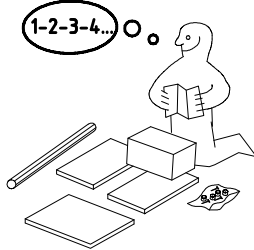
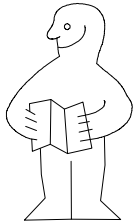

873 x 500 x 18

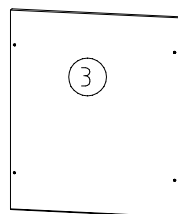

3x 429 x 500 x 18

1486x500x15

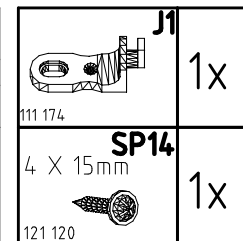
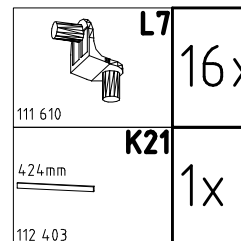
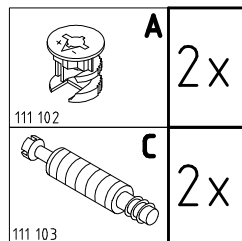
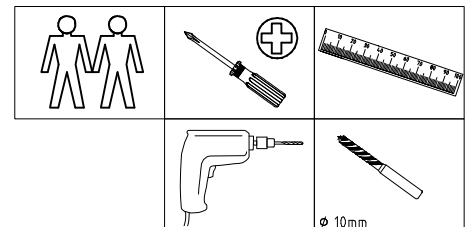

**980757**

17.06.11 / 09.09.13

09 13

1/4

1

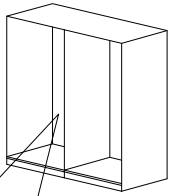

K20  
870mm  
112 402

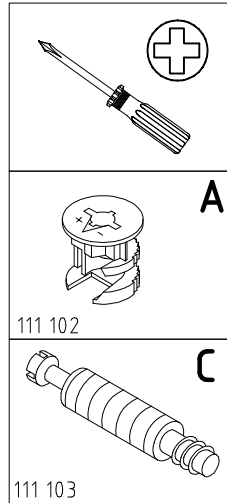
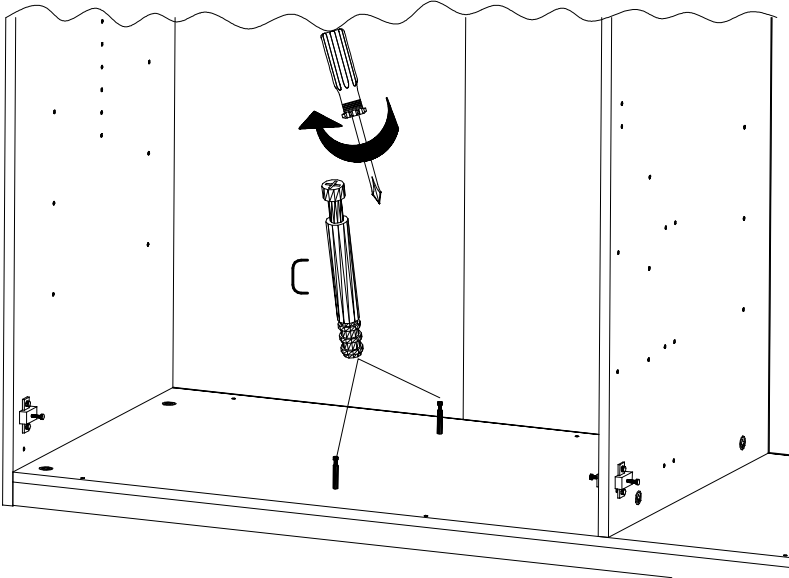
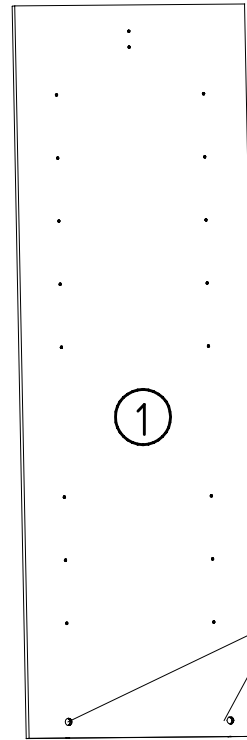
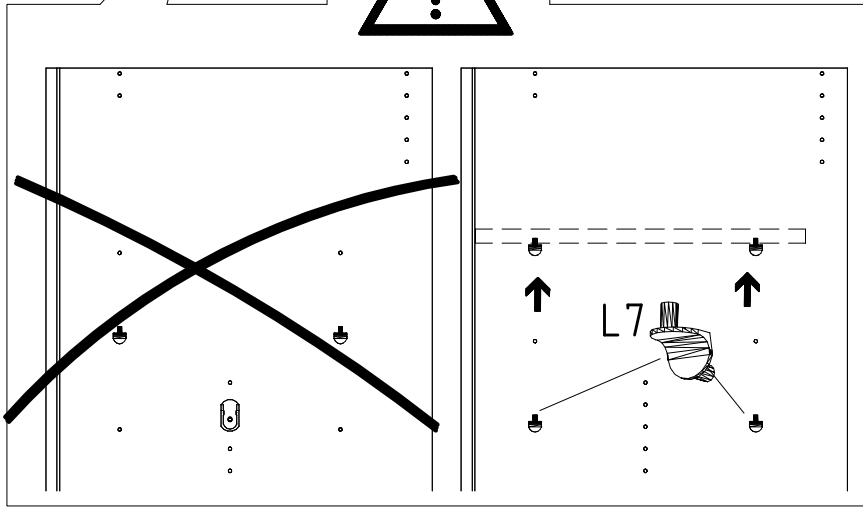
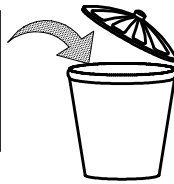

2

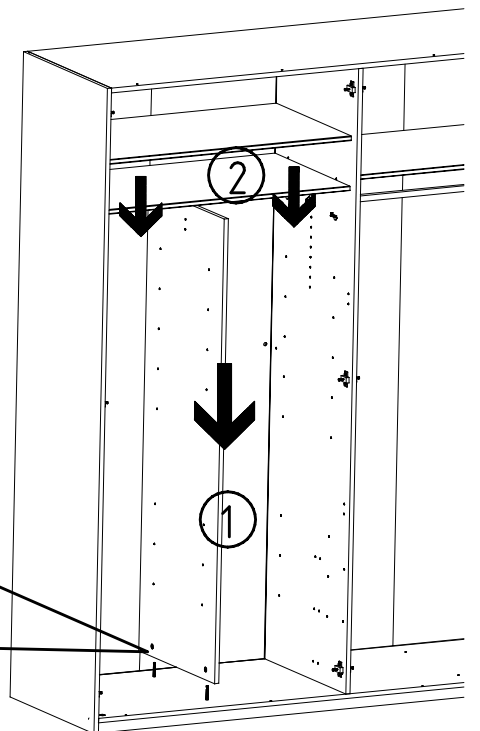
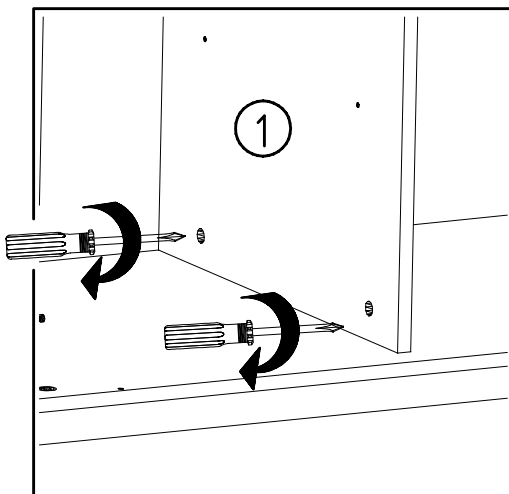
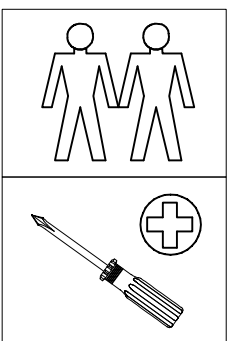

3

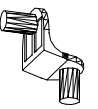
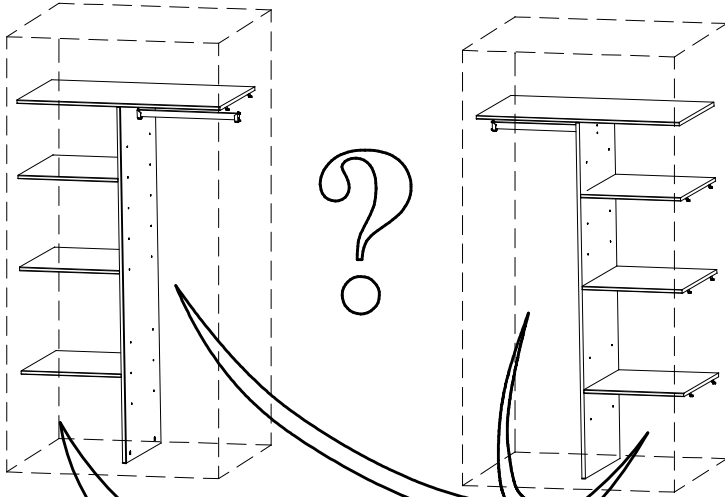

L7

111 610

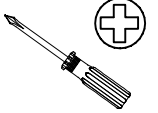

K1

117 001

3,5 x 15 mm

G1

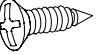

121 370

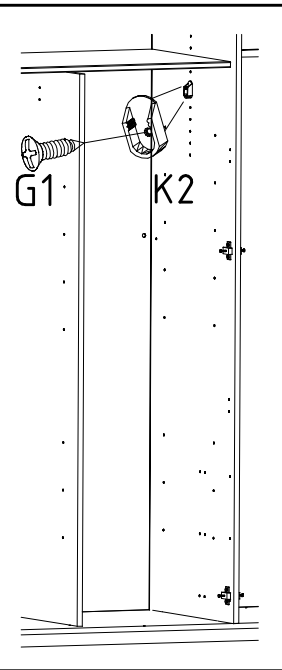
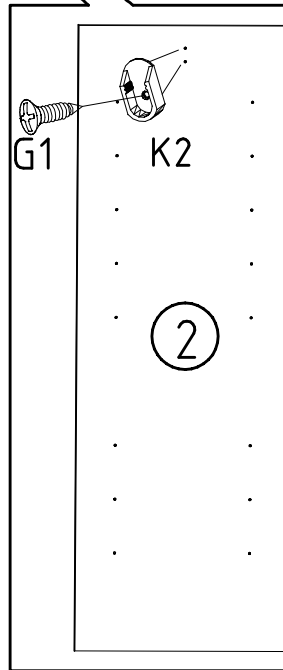
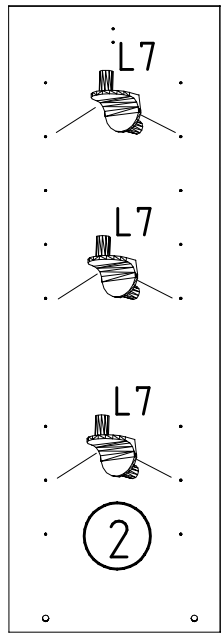
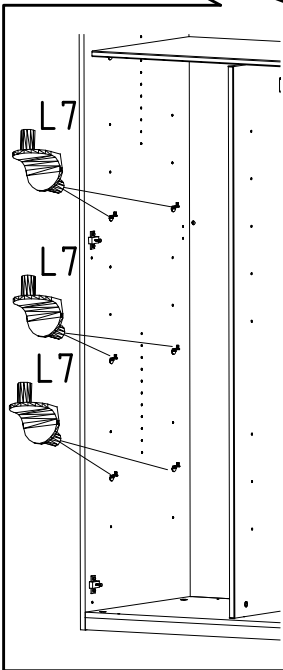

4

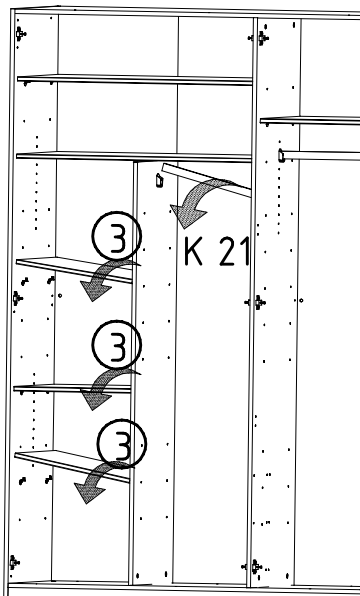
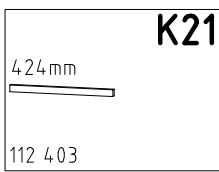

5

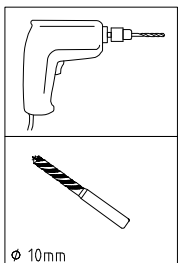
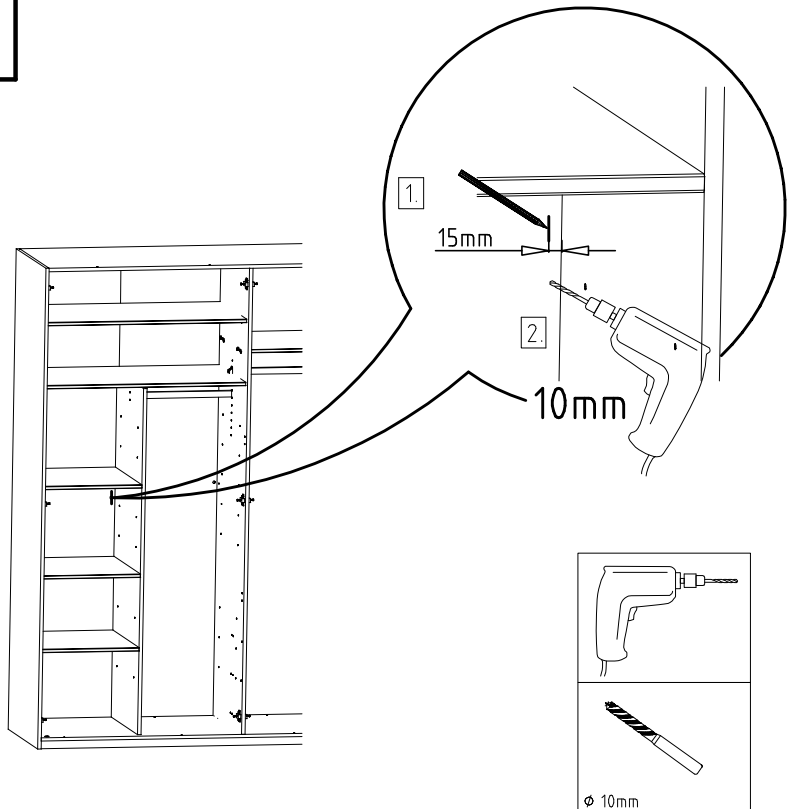

980757

17.06.11 / 09.09.13

09 13

3/4

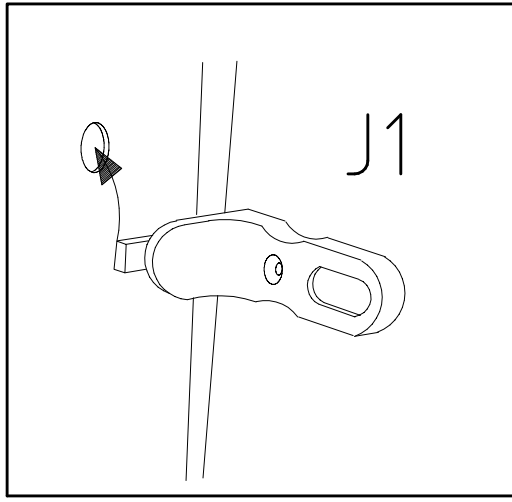

**J1**

111 174

**SP14**

4 X 15mm

121 120

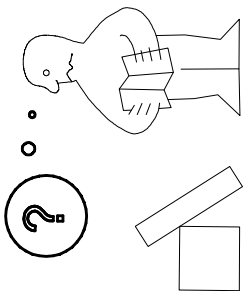
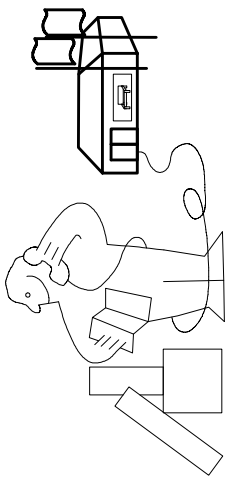
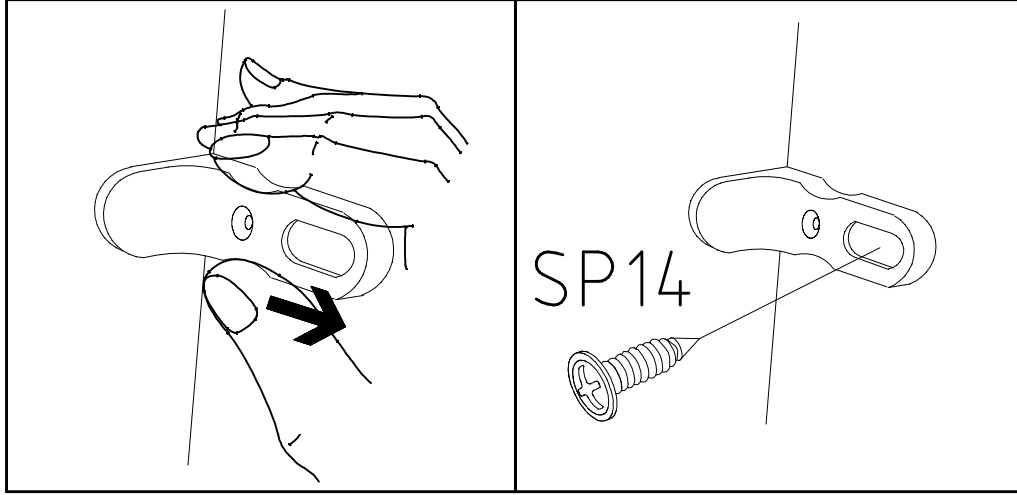

Modell/Model/Modèle

5.

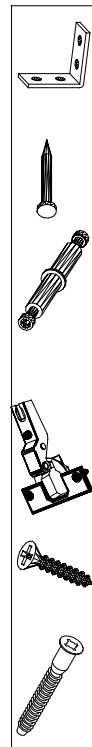

(121 370)	( G 1 )	(4x)

Änderungen die dem technischen Fortschritt geschuldet sind, behalten wir uns vor!  
 Bei nicht vorschriftsmäßiger und/ oder nicht fachmännischer Montage wird bei Personen- und/ oder Sachschäden keinerlei Haftung übernommen.

WIMEX Wohnbedarf/ Import Export Handels GmbH/ Postfach 1407/ 49112 Georgsmarienhütte/ Germany  
 Tel.:(+49) 054-01 8598 16/17 Fax.:(+49) 054-01 8598 33 Mail: info@wimex-wohnbefarf.de