

WERSION B

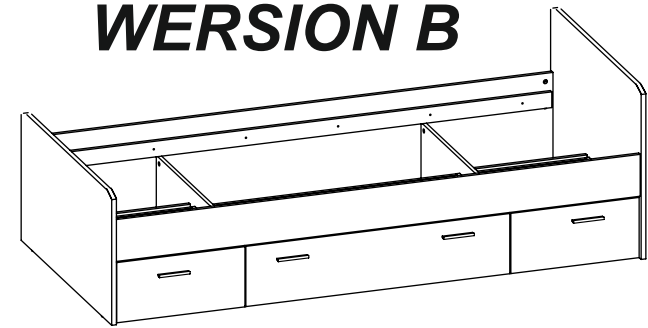

WERSION A

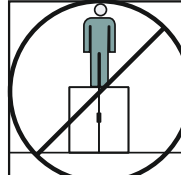

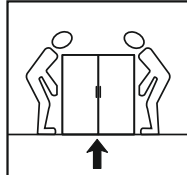
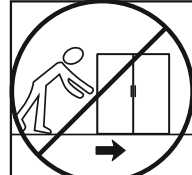
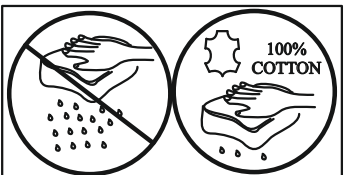
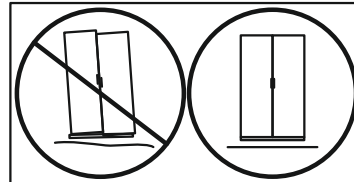
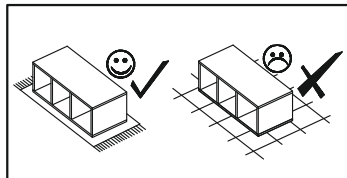
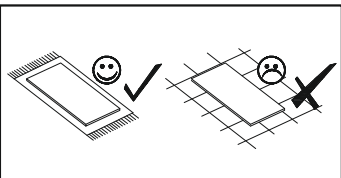
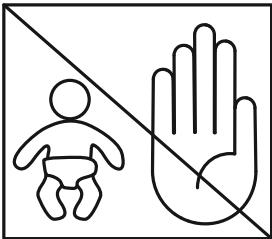
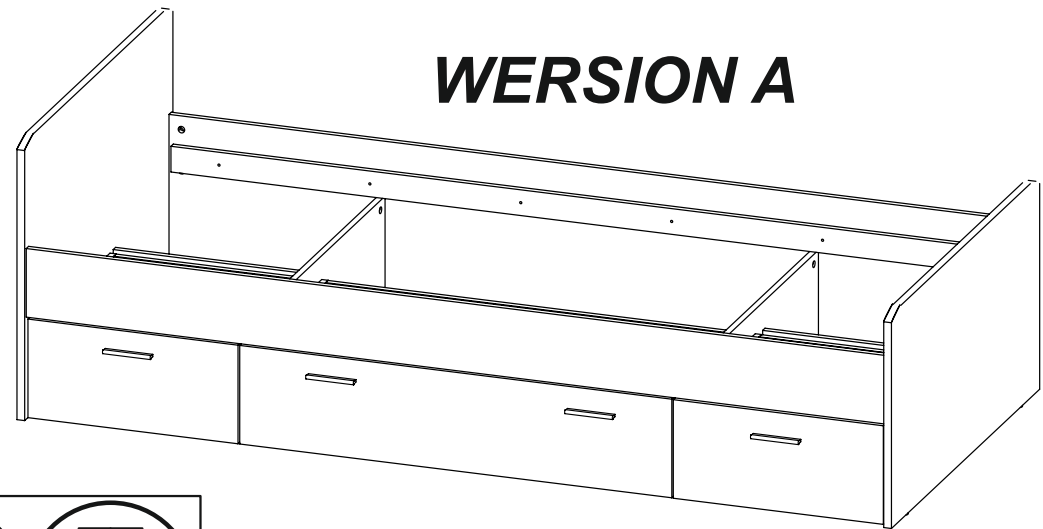
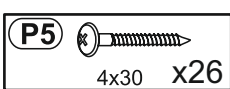
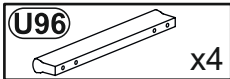
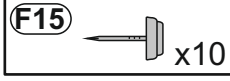
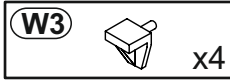
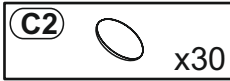
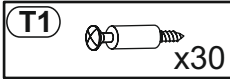
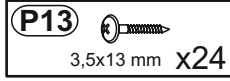
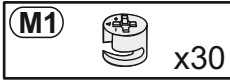
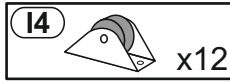
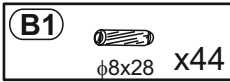

Nr	Ausmaß			St
16	475	270	15	1
15	974	487	2,5	1
14	456	487	2,5	2
13	963	194	15	1
12	445	194	15	2
11	490	194	15	3
10	490	194	15	3
9	490	230	15	2
8	1008	230	15	1
7	1984	60	22	2
6	489	140	15	2
5	900	270	15	2
4	2004	160	15	1
3	2004	398	15	1
2	950	500	18	1
1	950	650	18	1

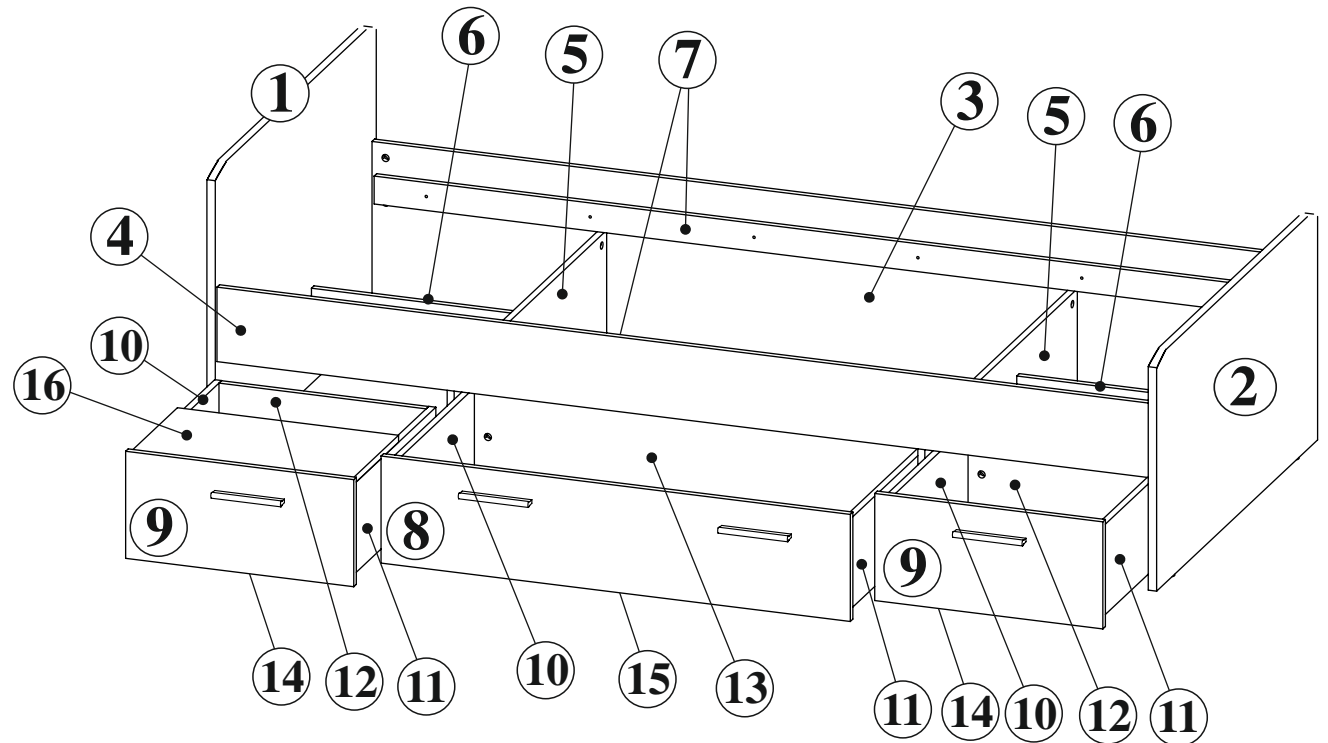

1

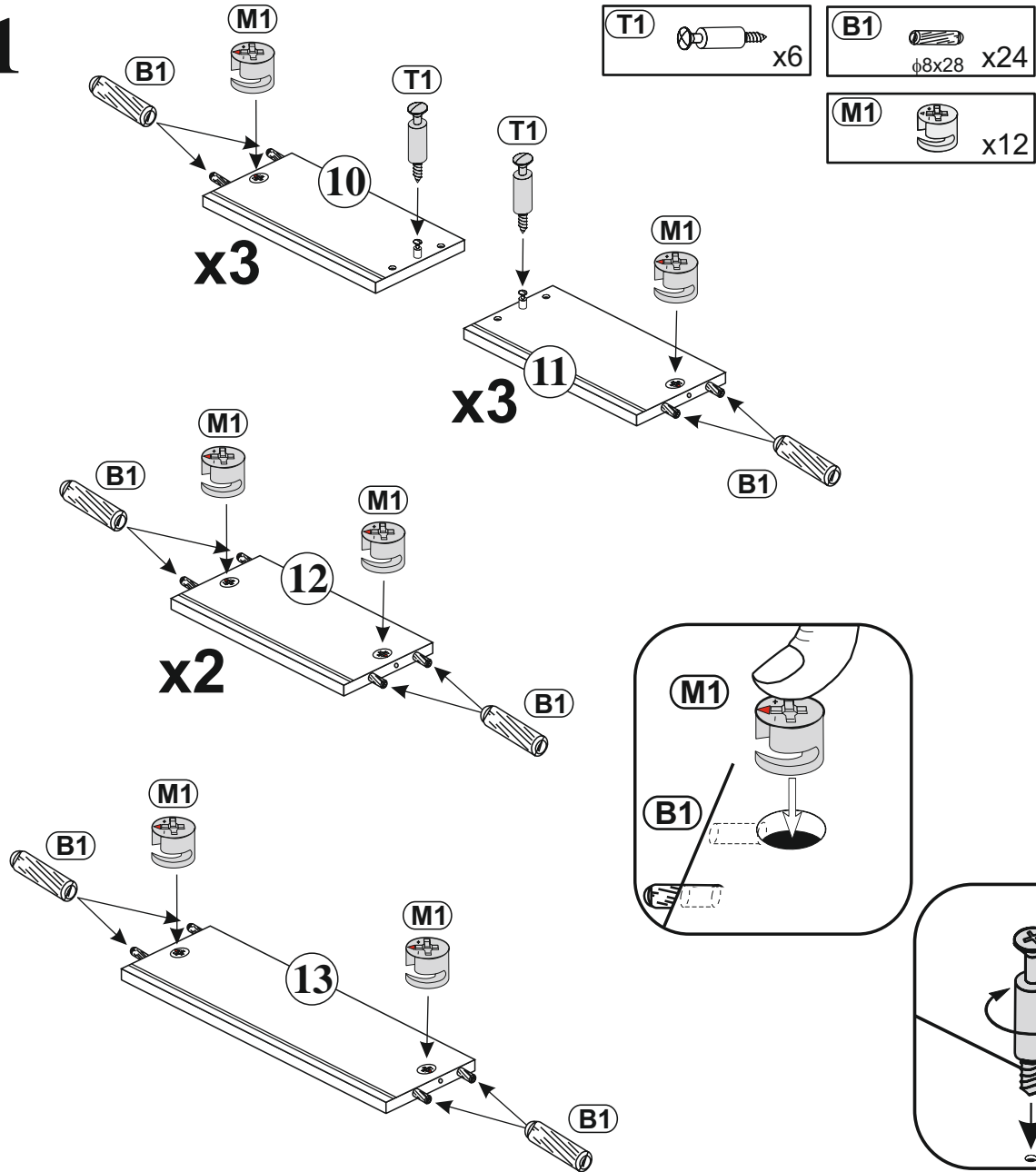

2

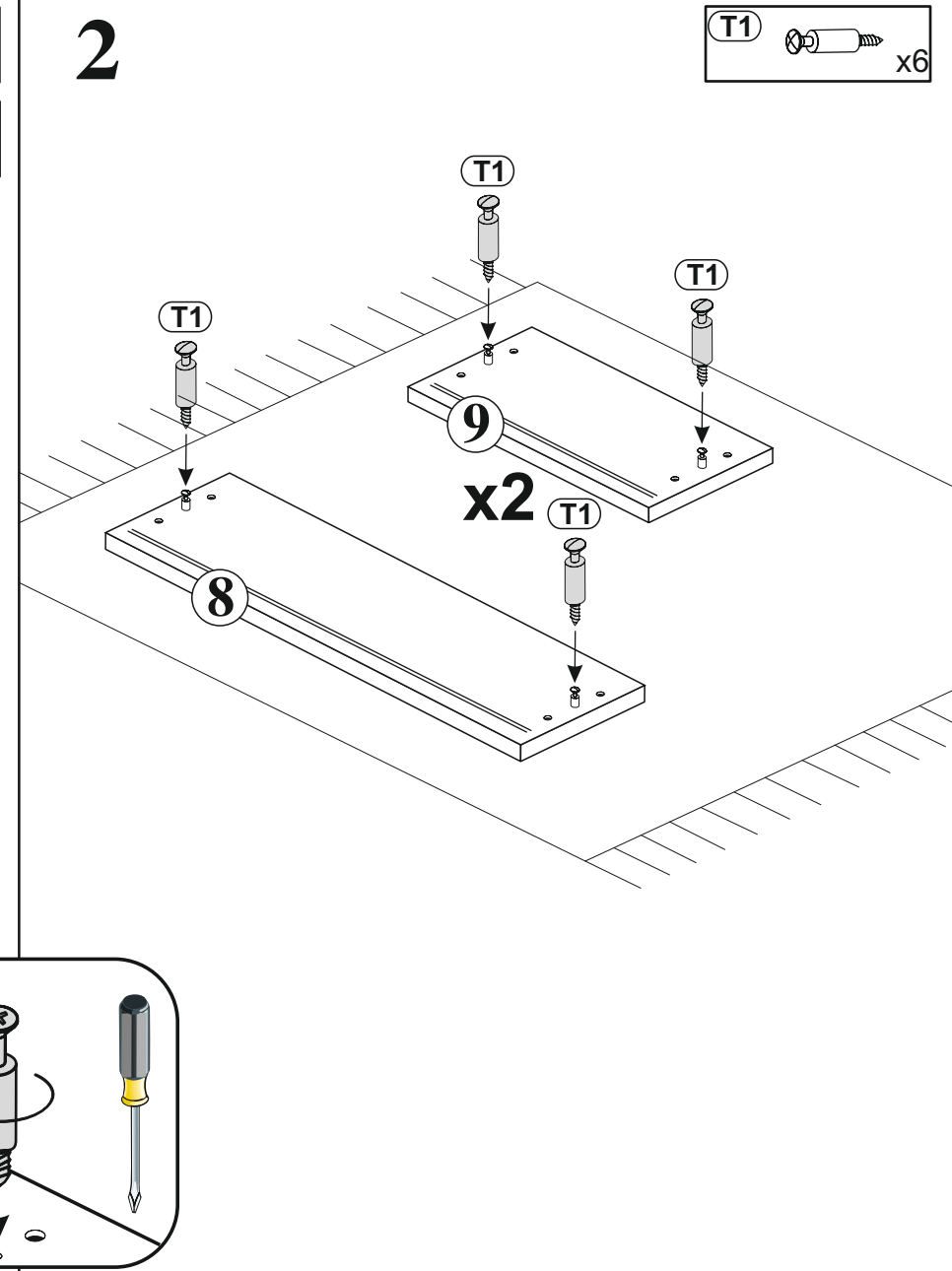

3

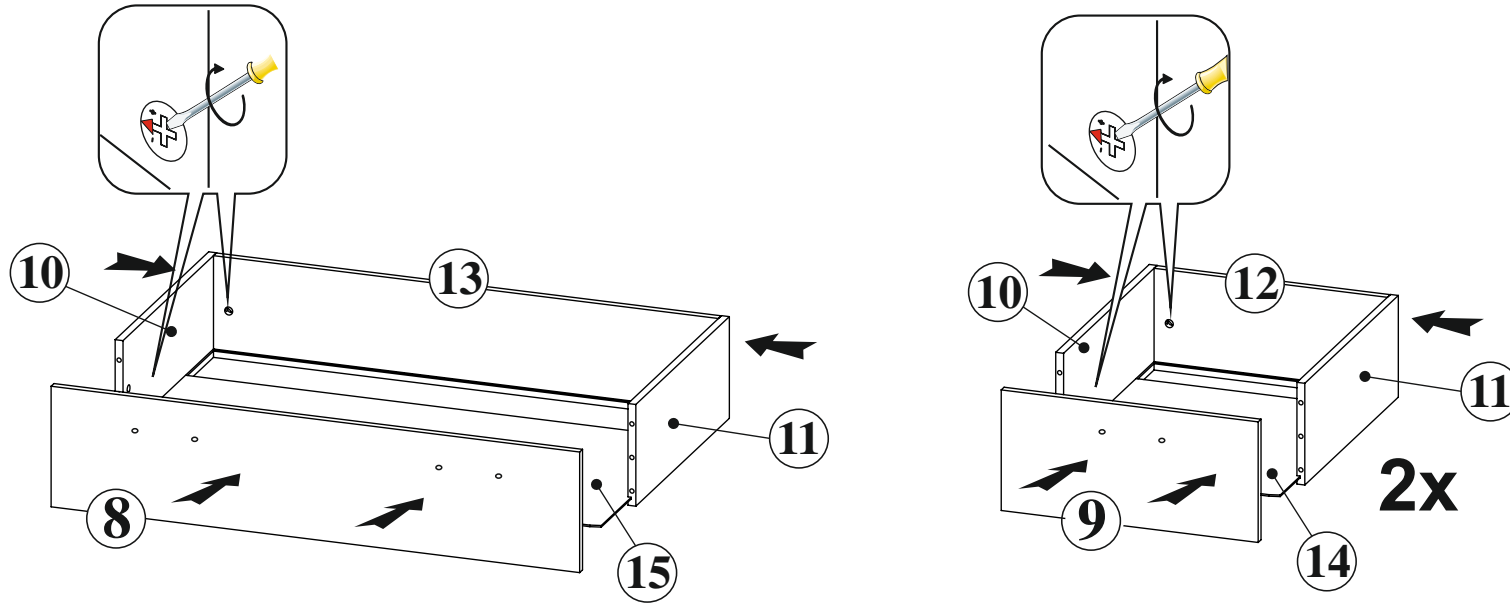

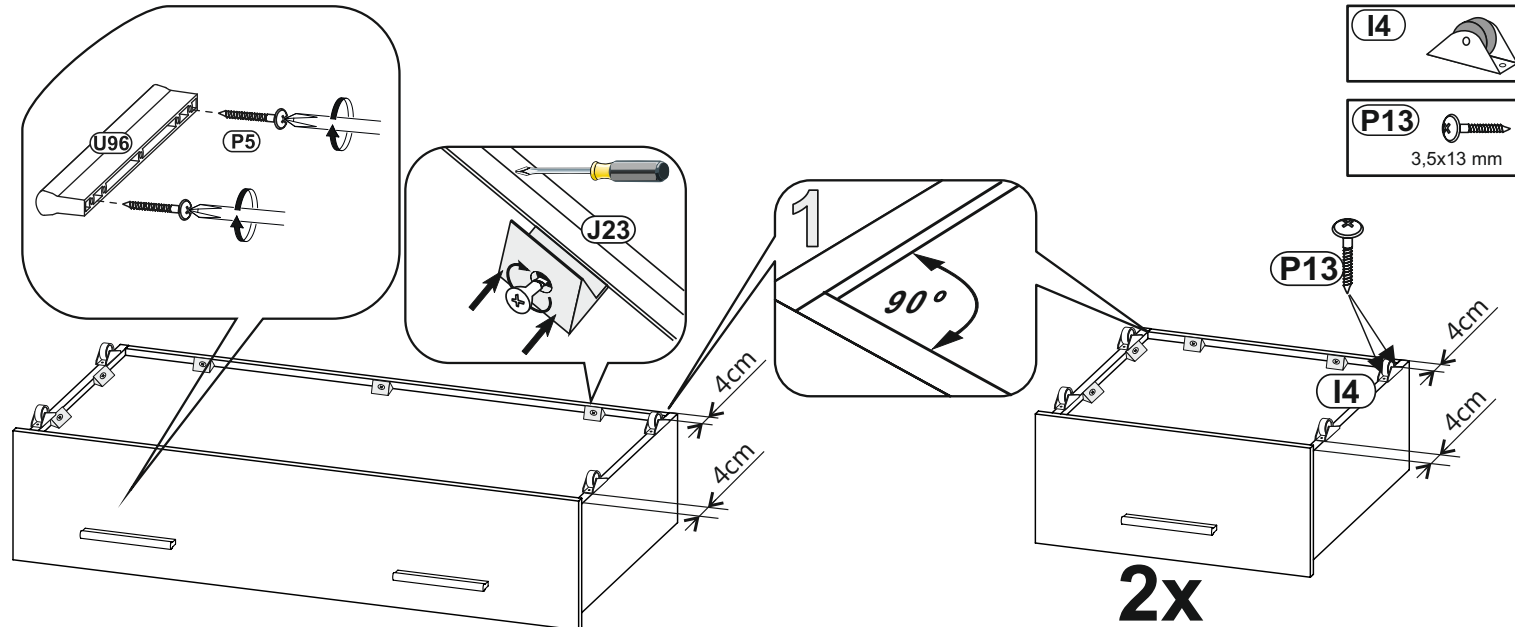
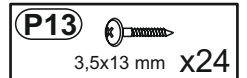
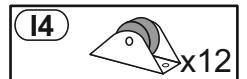
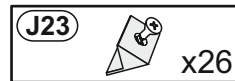
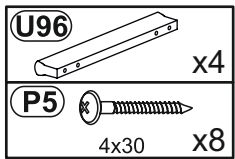

4



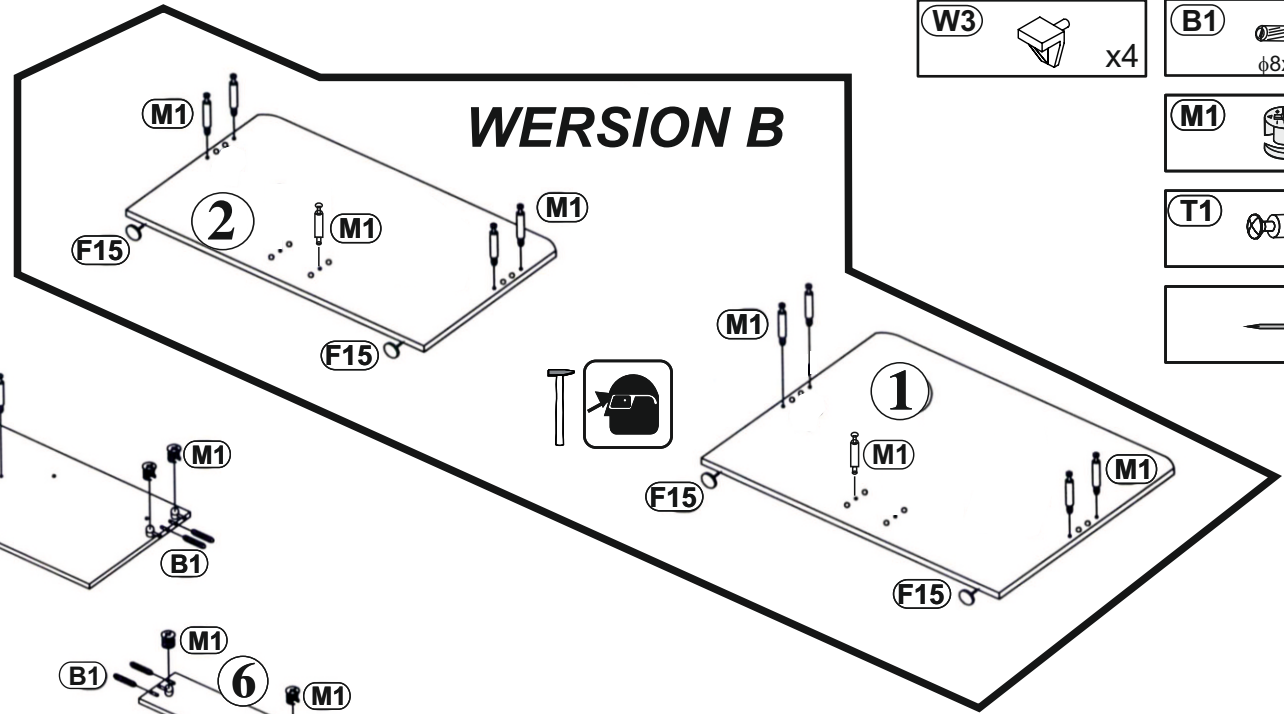

5 WERSION A



W3  x4

B1  $\phi 8 \times 28$ x20

M1  x12

T1  x12

 x10

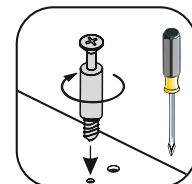
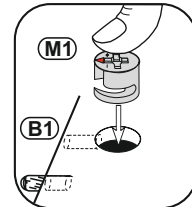
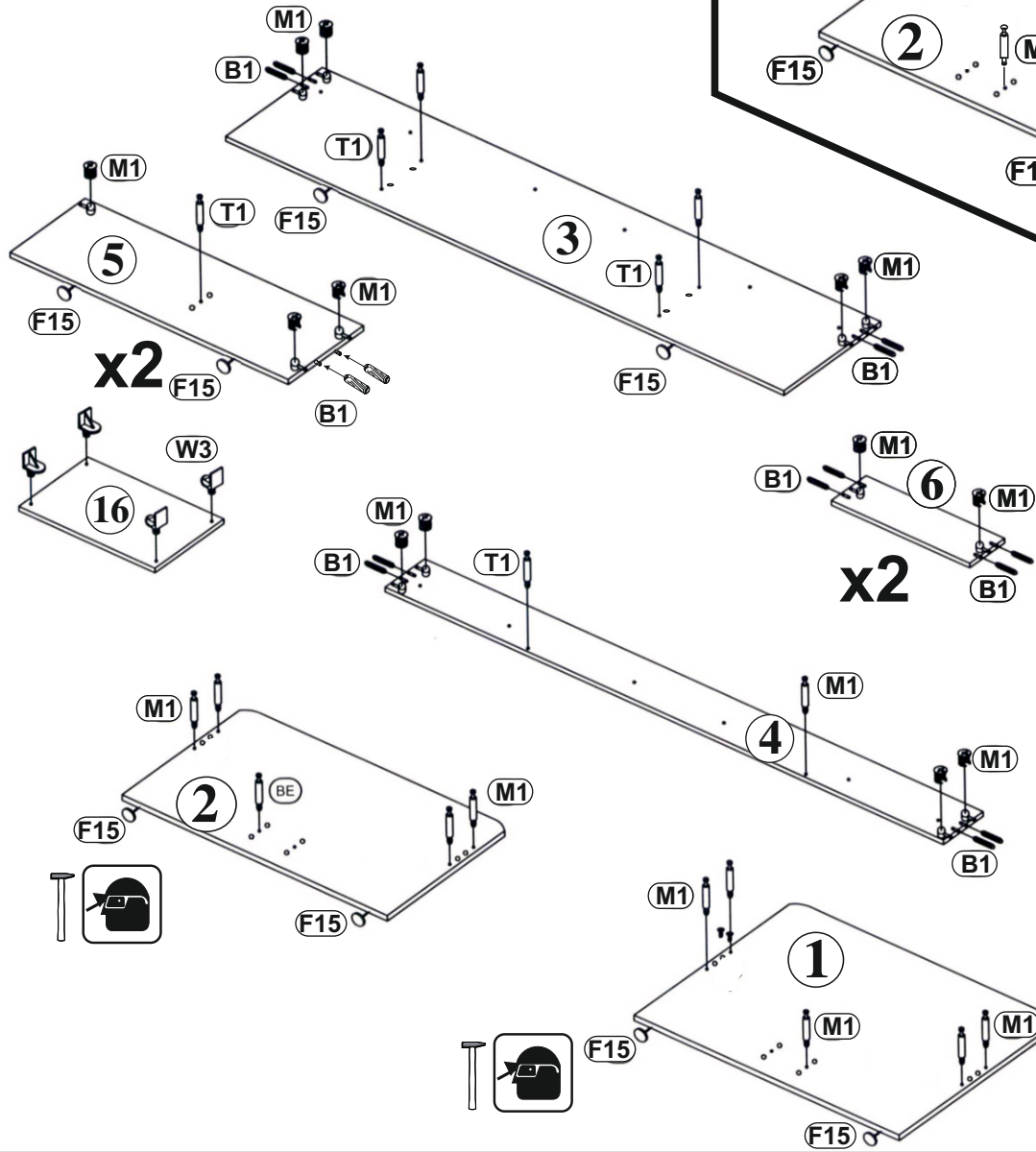

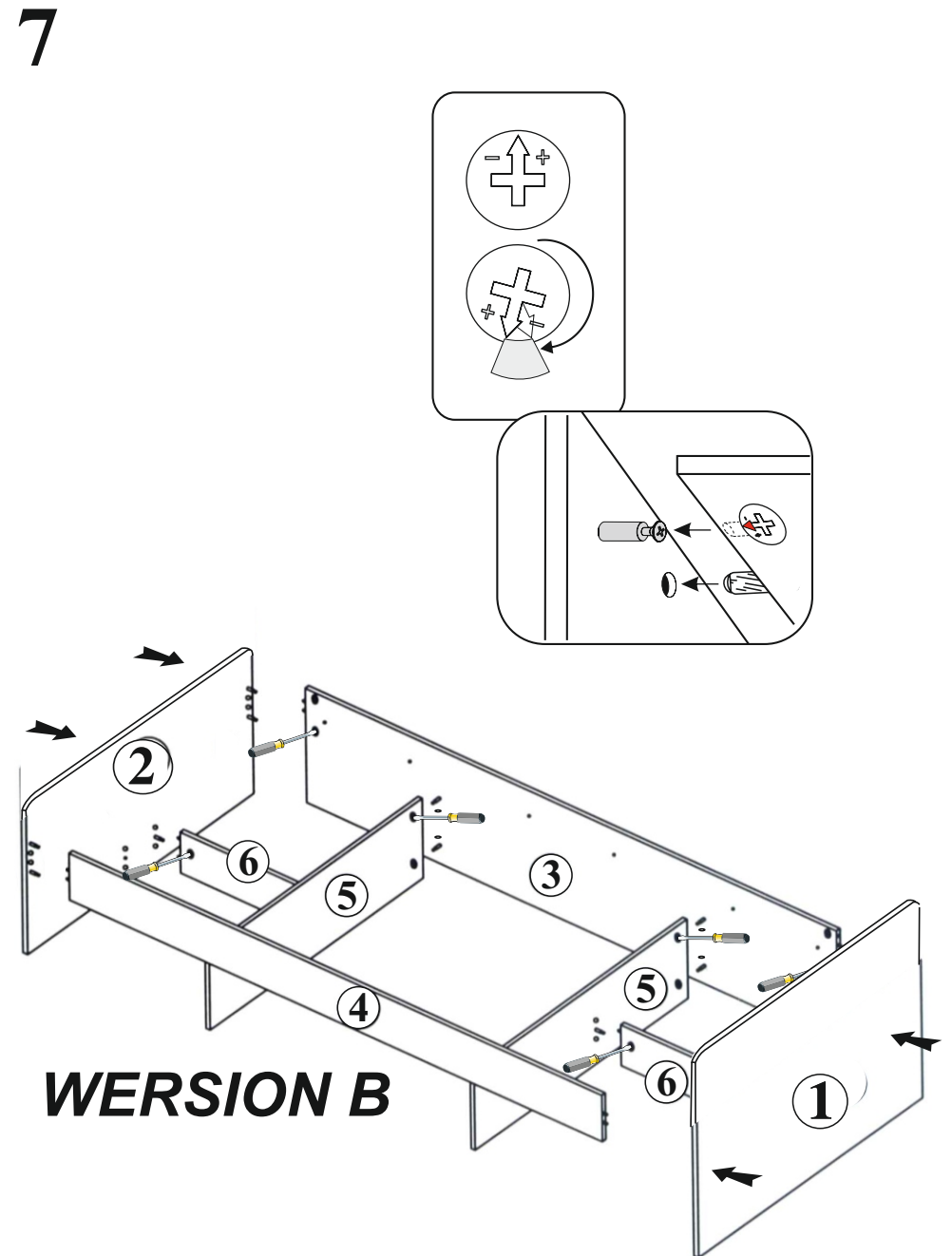
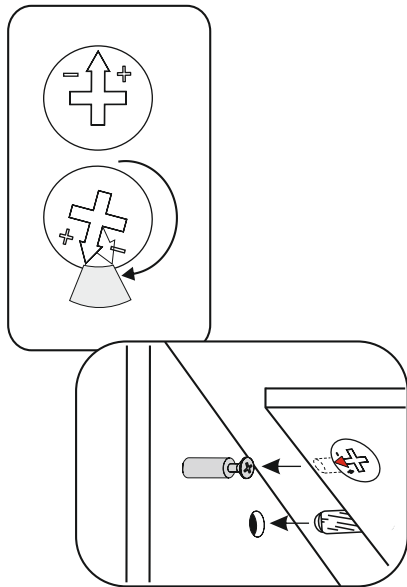
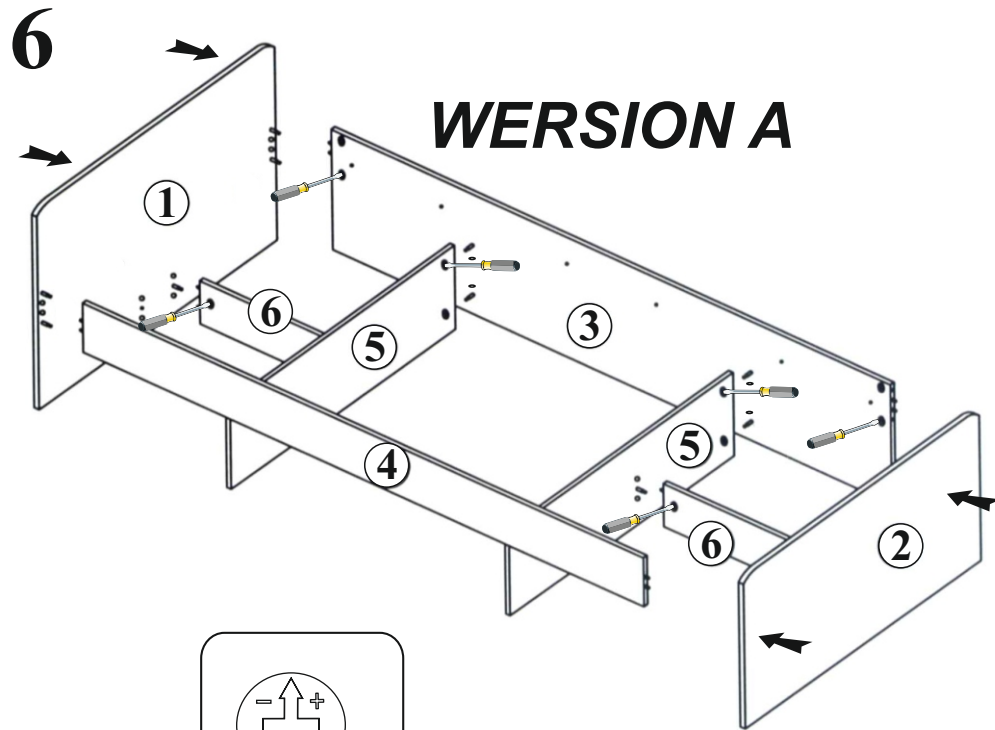

8

