

AVENSIS NEW 204

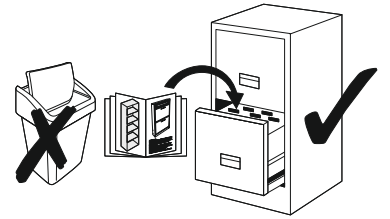

max. 7 kg

max. 30 kg

max. 5 kg

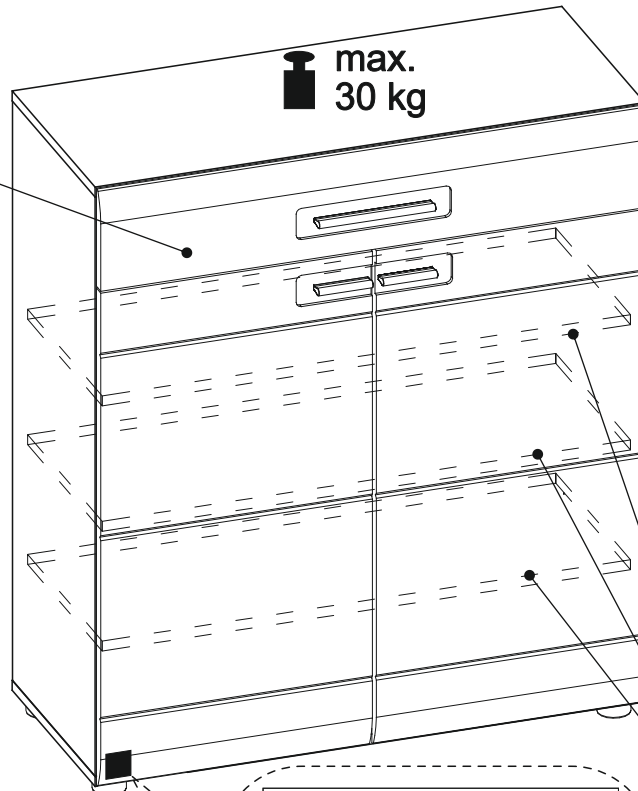
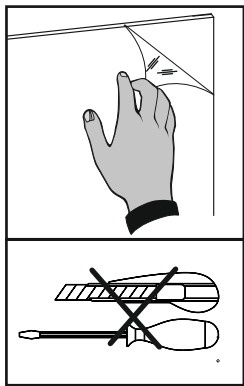

- | | | |
|--------|--------|--------|
| ① - C1 | ⑥ - C2 | ⑪ - C2 |
| ② - C1 | ⑦ - C2 | ⑫ - C1 |
| ③ - C1 | ⑧ - C2 | ⑬ - C2 |
| ④ - C1 | ⑨ - C2 | |
| ⑤ - C1 | ⑩ - C2 | |

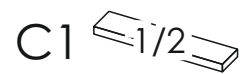

1803

AVENSIS NEW 204

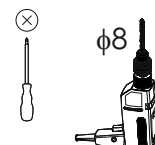
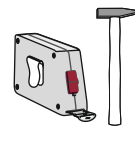
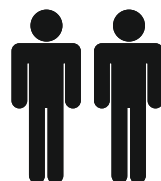
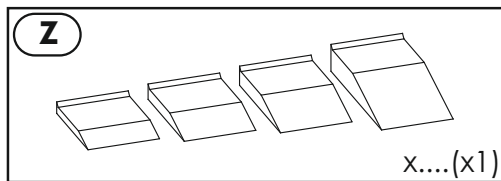
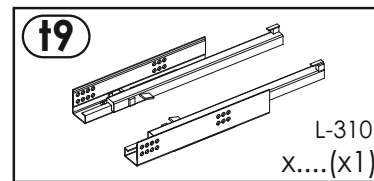
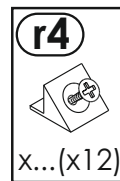
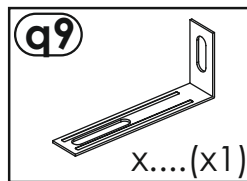
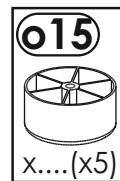
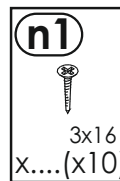
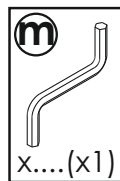
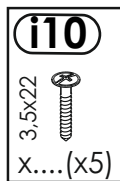
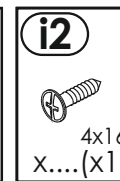
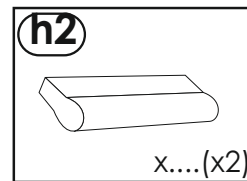
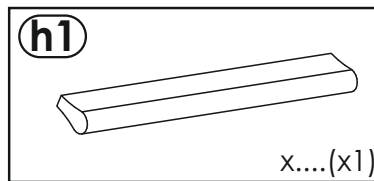
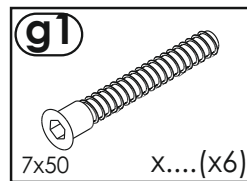
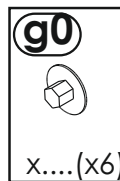
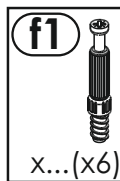
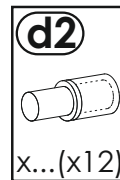
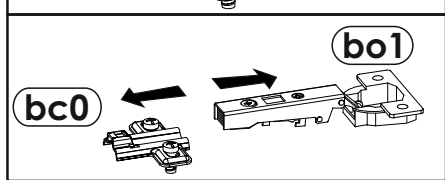
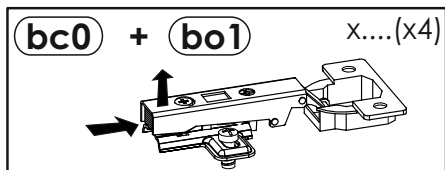
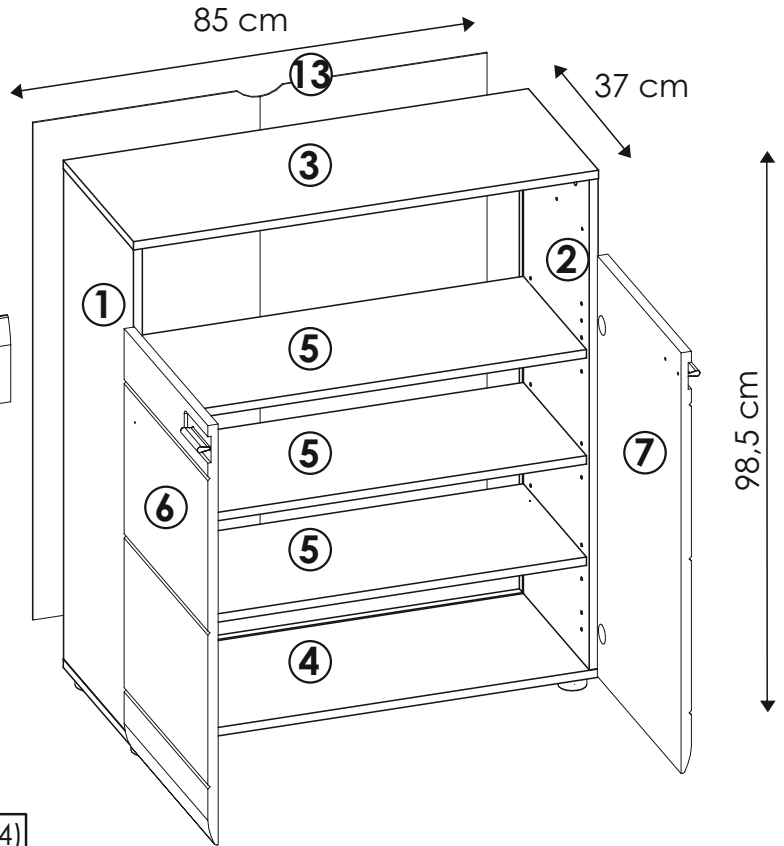

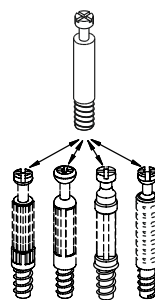
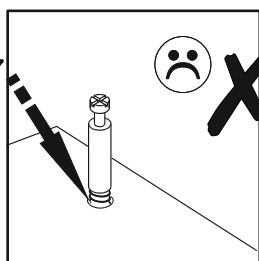
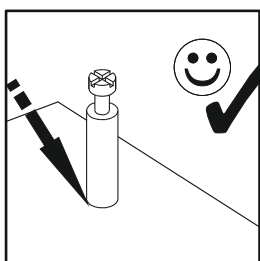
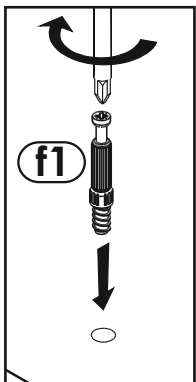
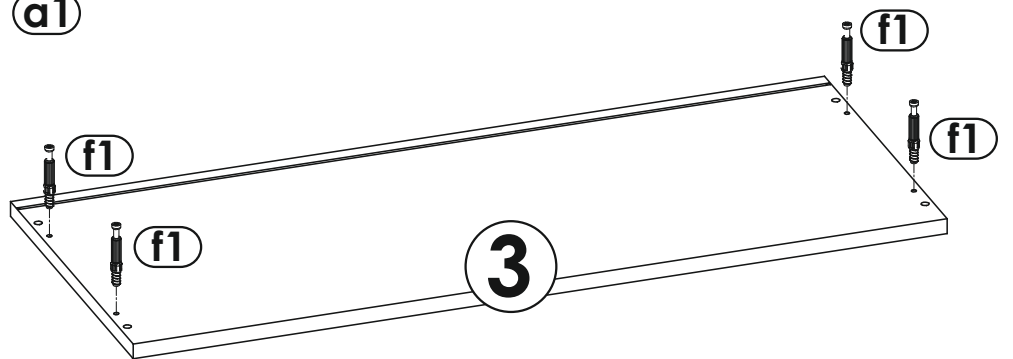
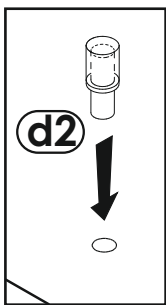
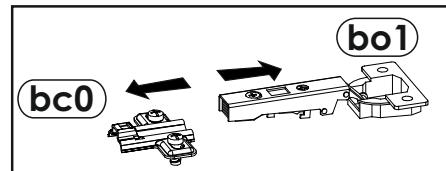
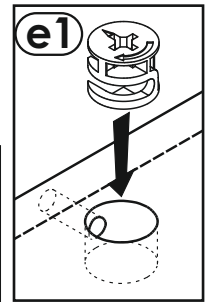
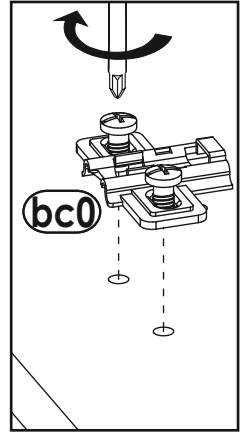
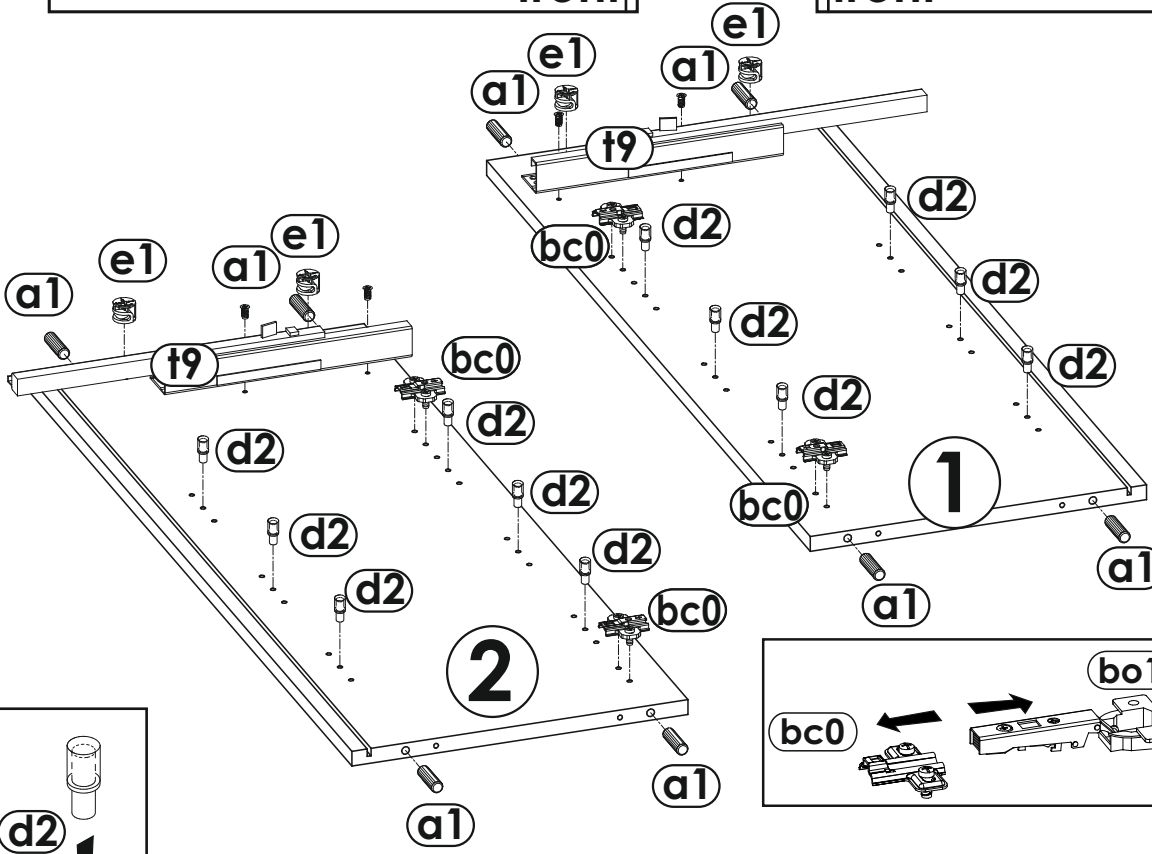
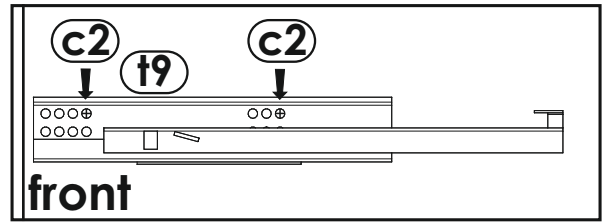
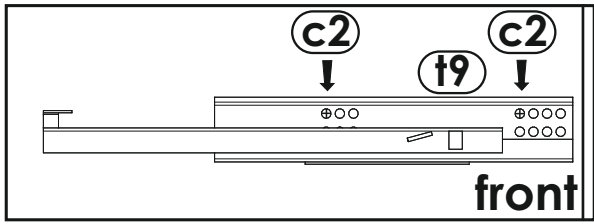
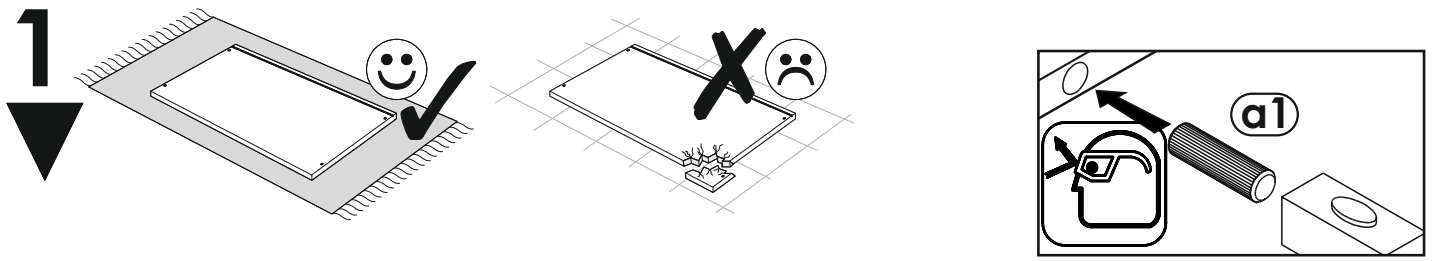

2

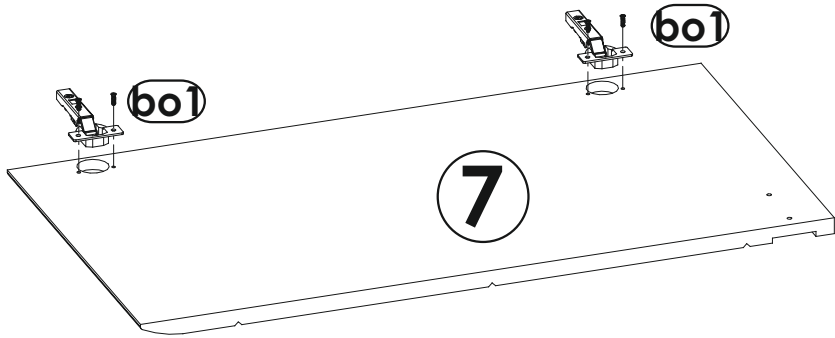
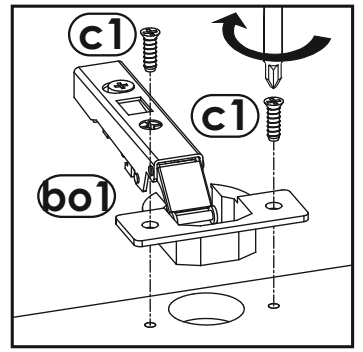
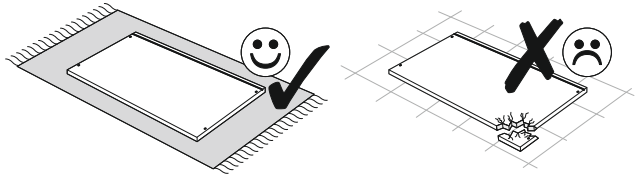

7

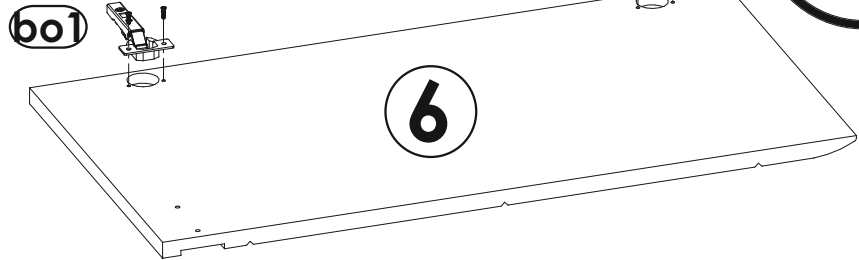

6

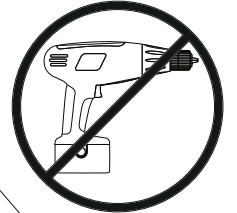
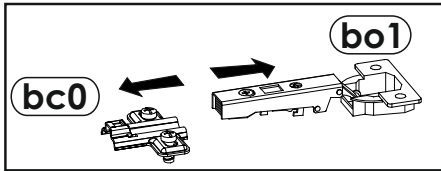

3

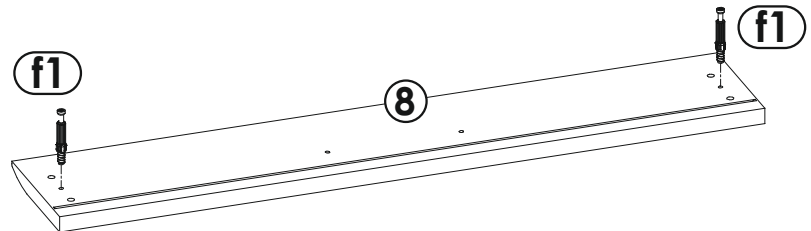
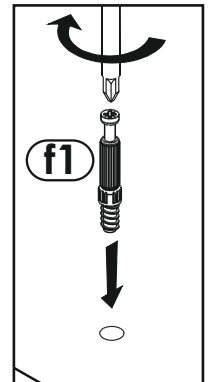
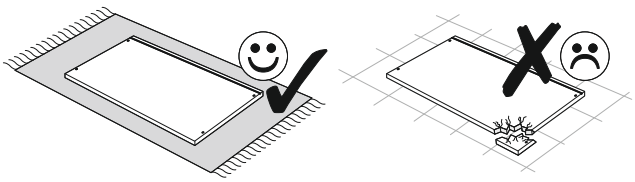

8

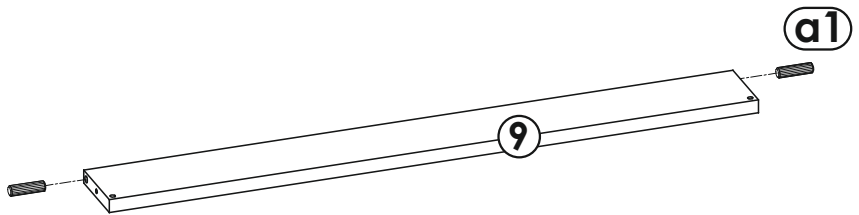

9

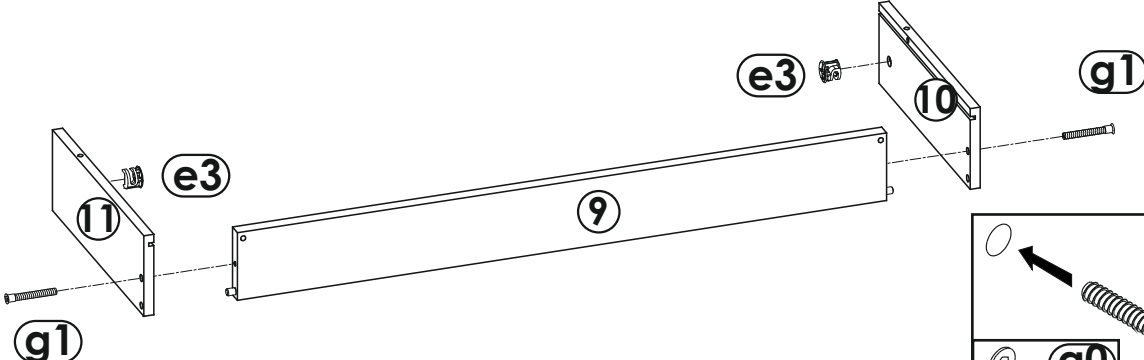
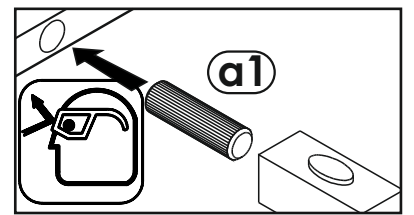

11

9

e3

g1

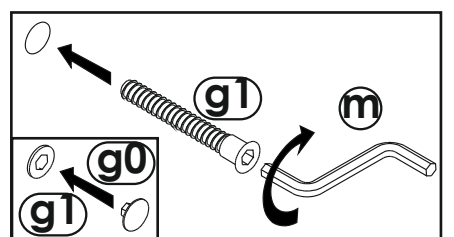

g0

g1

4
▼

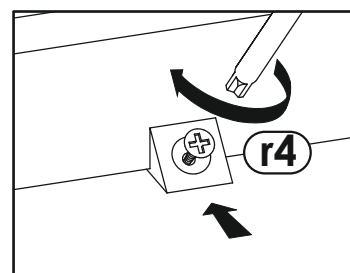
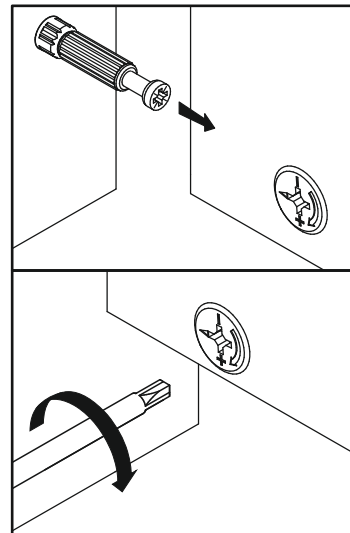
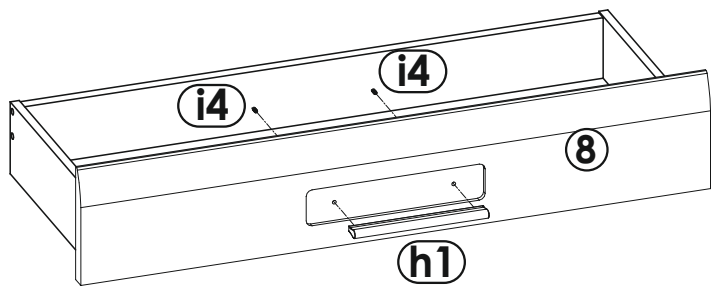
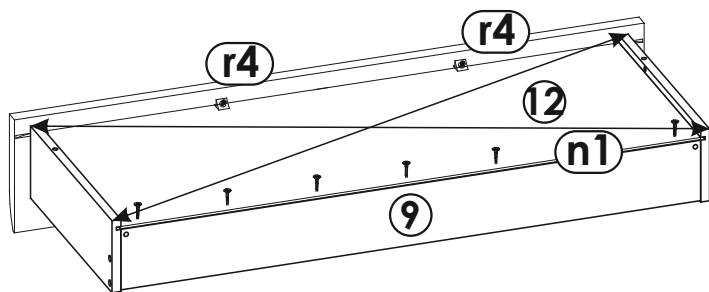
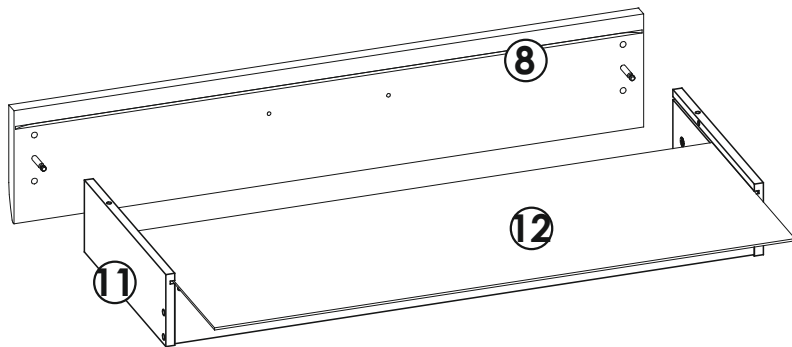
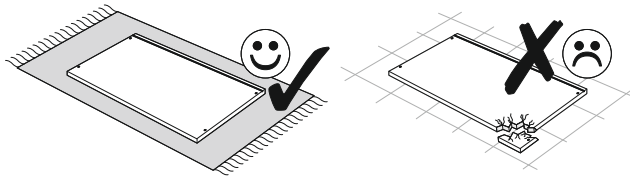

5

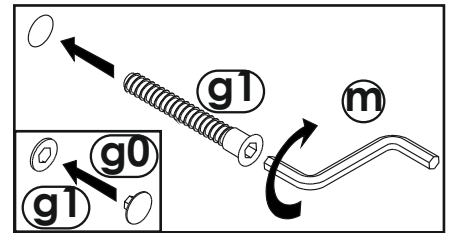
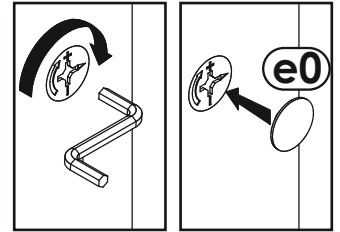
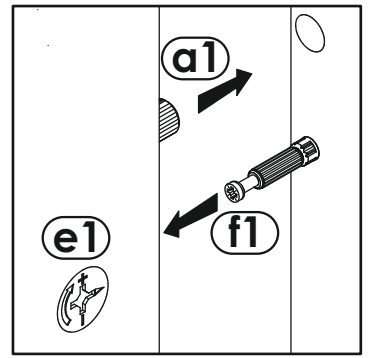
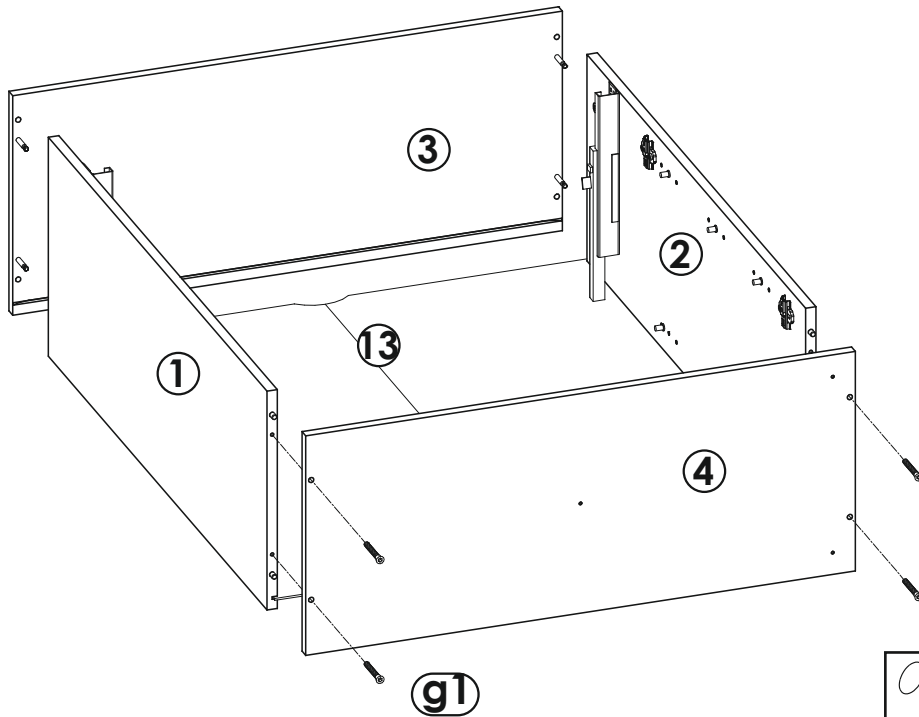
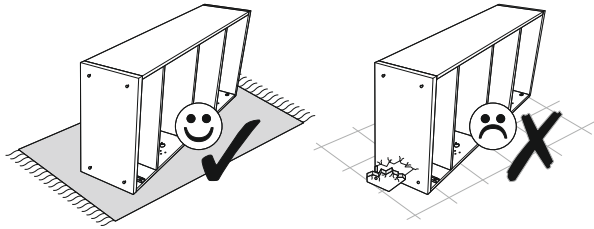

6

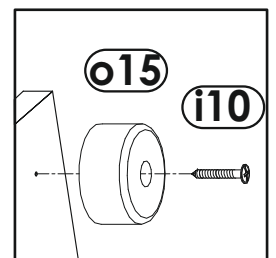
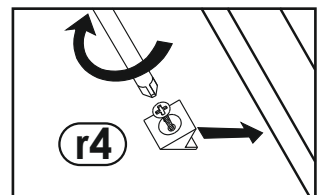
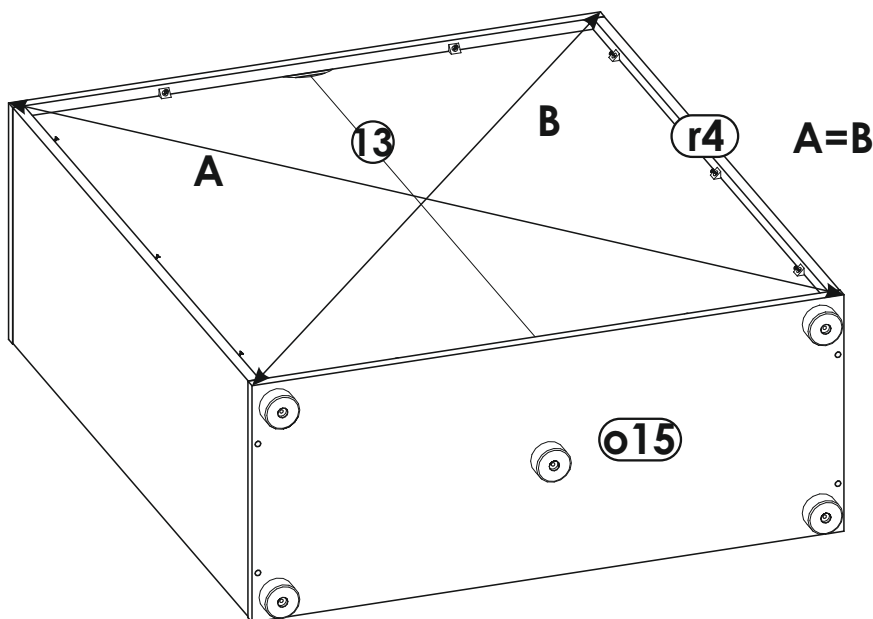

7

