

PARIS

137 T

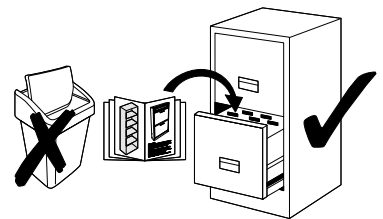

a1 8x35 x....(x8)	a2 8x45 x....(x8)	e0 x....(x44)	e1 x....(x44)	f1 x....(x12)	f3 x....(x16)	m x....(x1)	n2 3,5x16 x....(x20)	o2 x....(x12)	q x....(x10)
------------------------------------	------------------------------------	-----------------------------	-----------------------------	-----------------------------	-----------------------------	---------------------------	---------------------------------------	-----------------------------	----------------------------

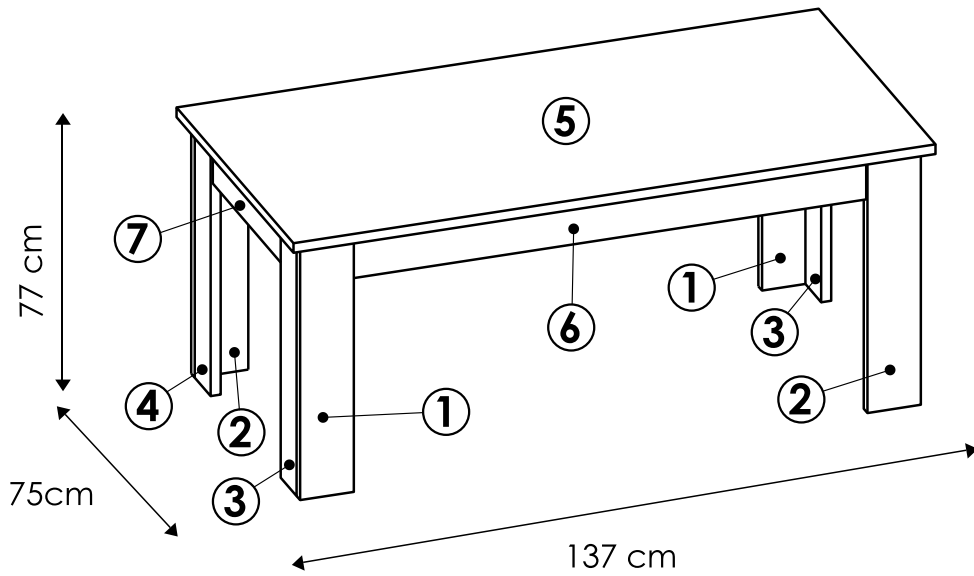
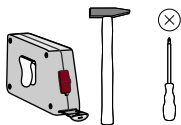
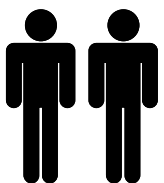

- 60 min.

1

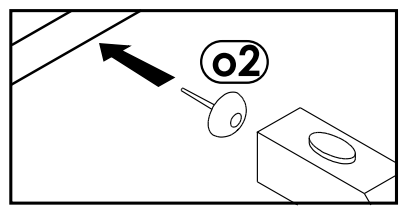
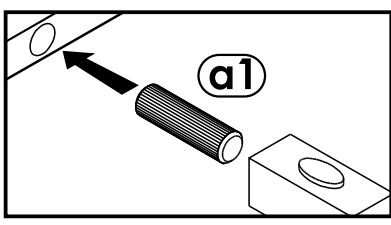
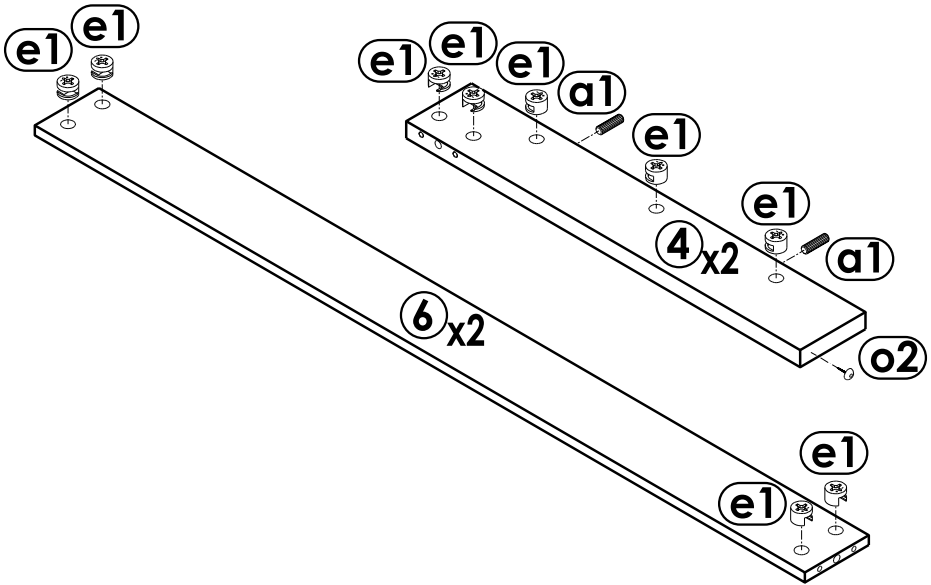
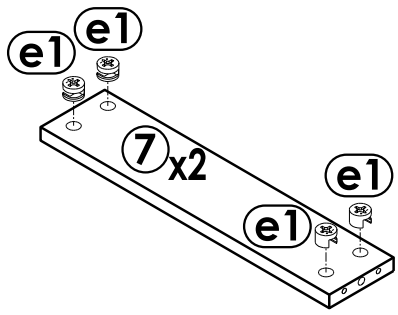
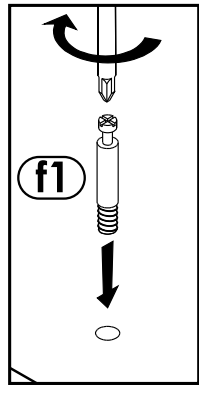
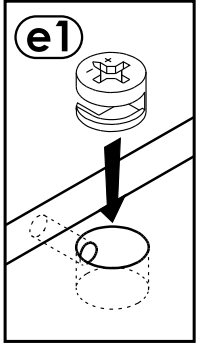
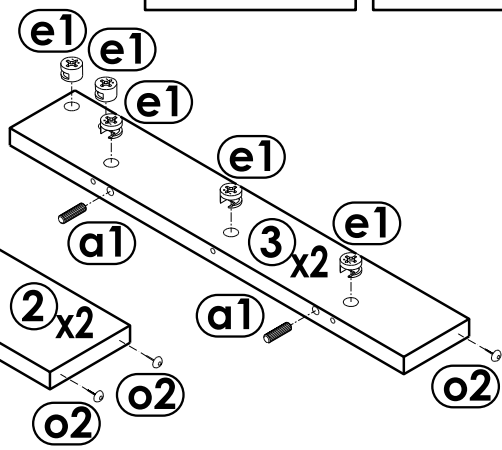
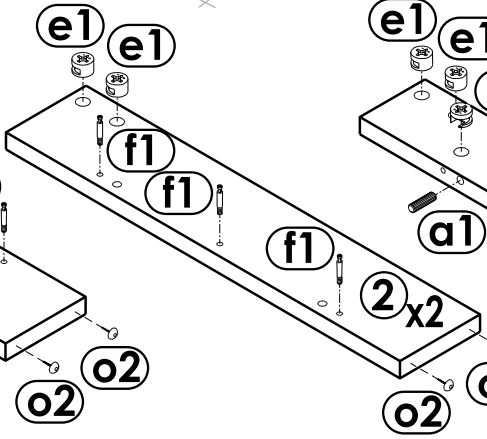
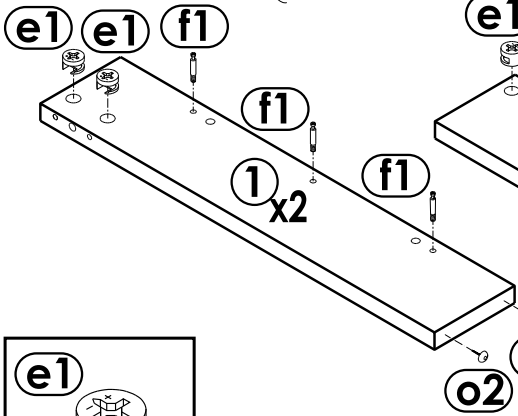
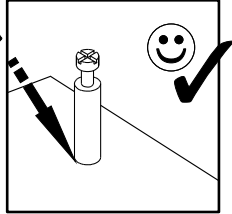
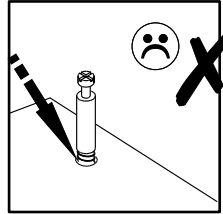
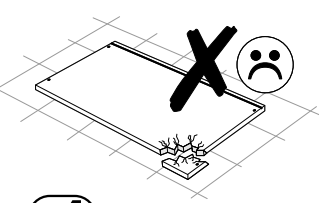
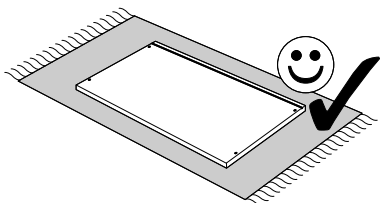

2

