

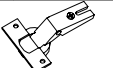









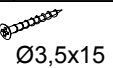



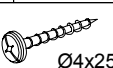

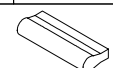
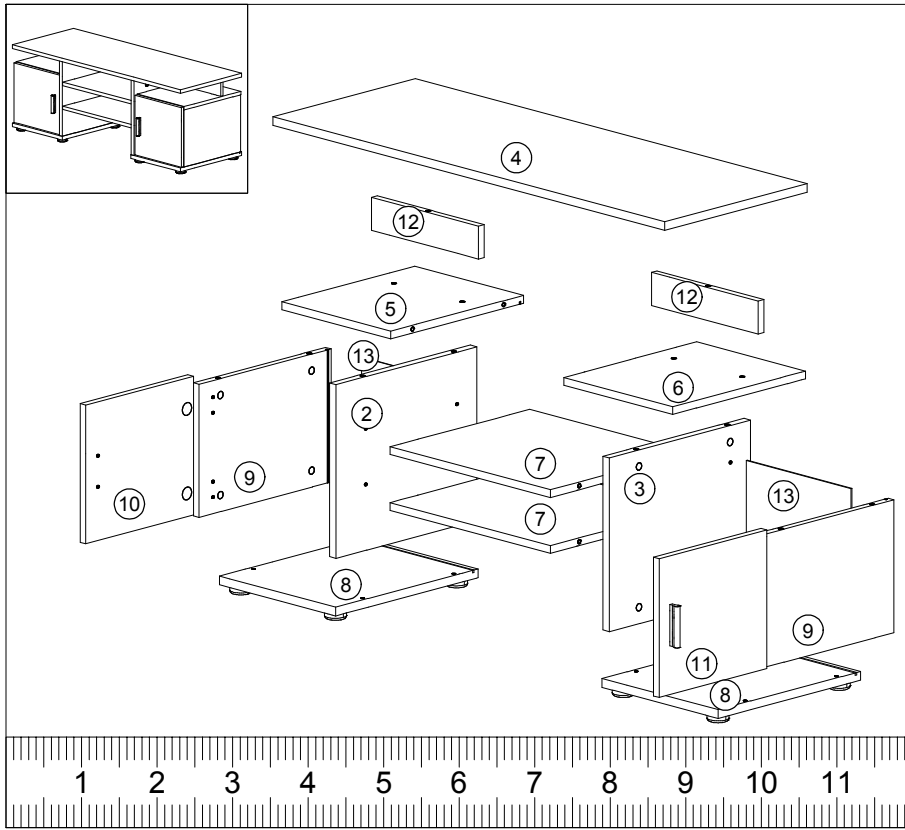

A 30x	B 30x
	
C 2x	D 4x
	
E 4x	F 8x
	
G 8x	H 30x
	
I 4x	J 8x
	
K 4x	L 2x

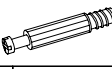

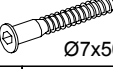
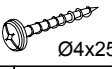

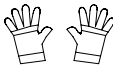
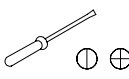
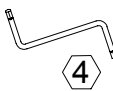

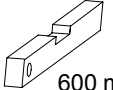
# EVA TV

	1100
	416
	400

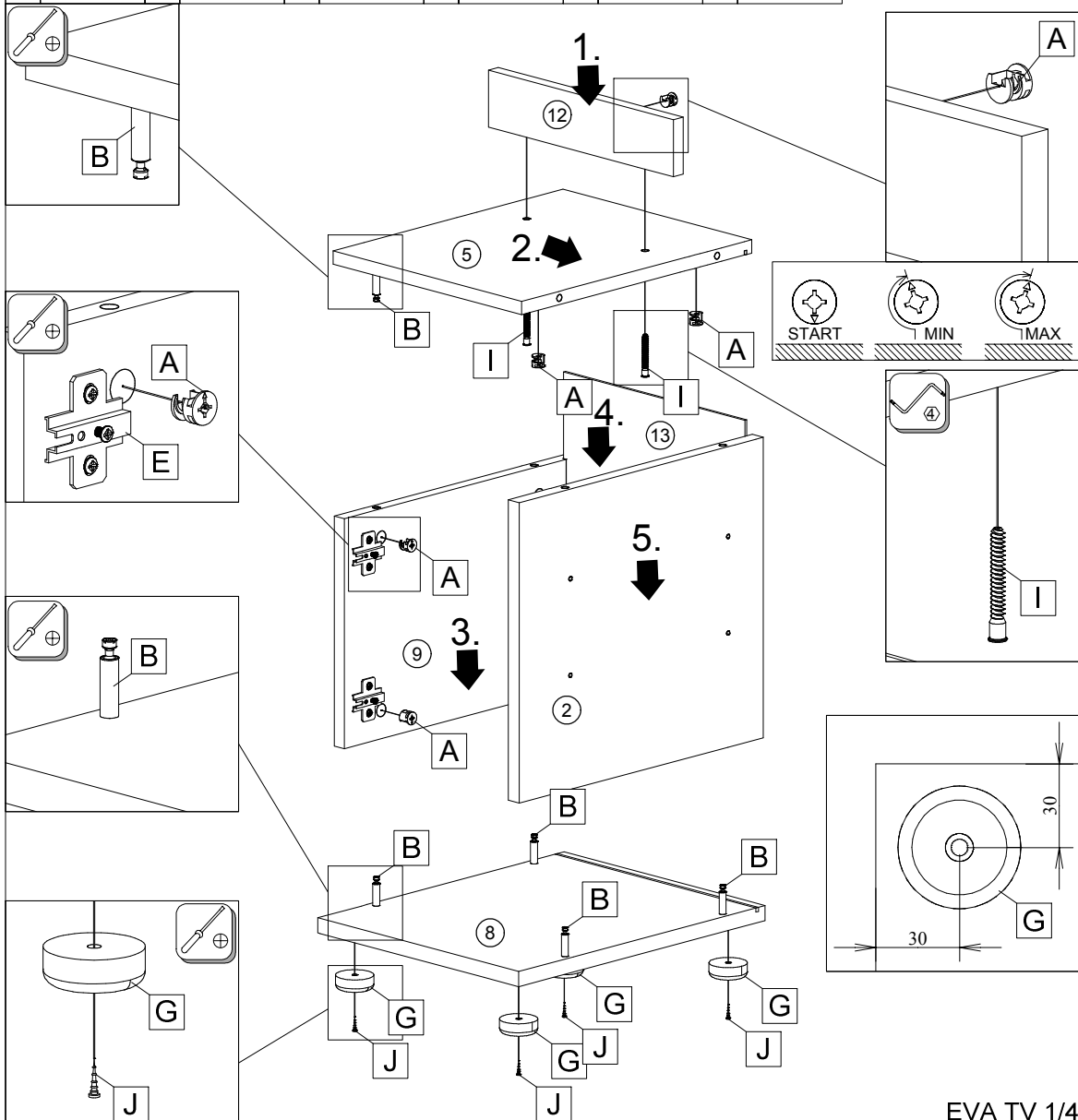
					
A 9x	B 8x	E 2x	G 4x	I 2x	J 4x

	
	1h 00min
	
	
4	≤ 0,5 kg
	
3m	600 mm

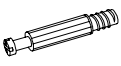

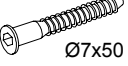
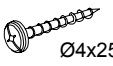
					
A 9x	B 8x	E 2x	G 4x	I 2x	J 4x

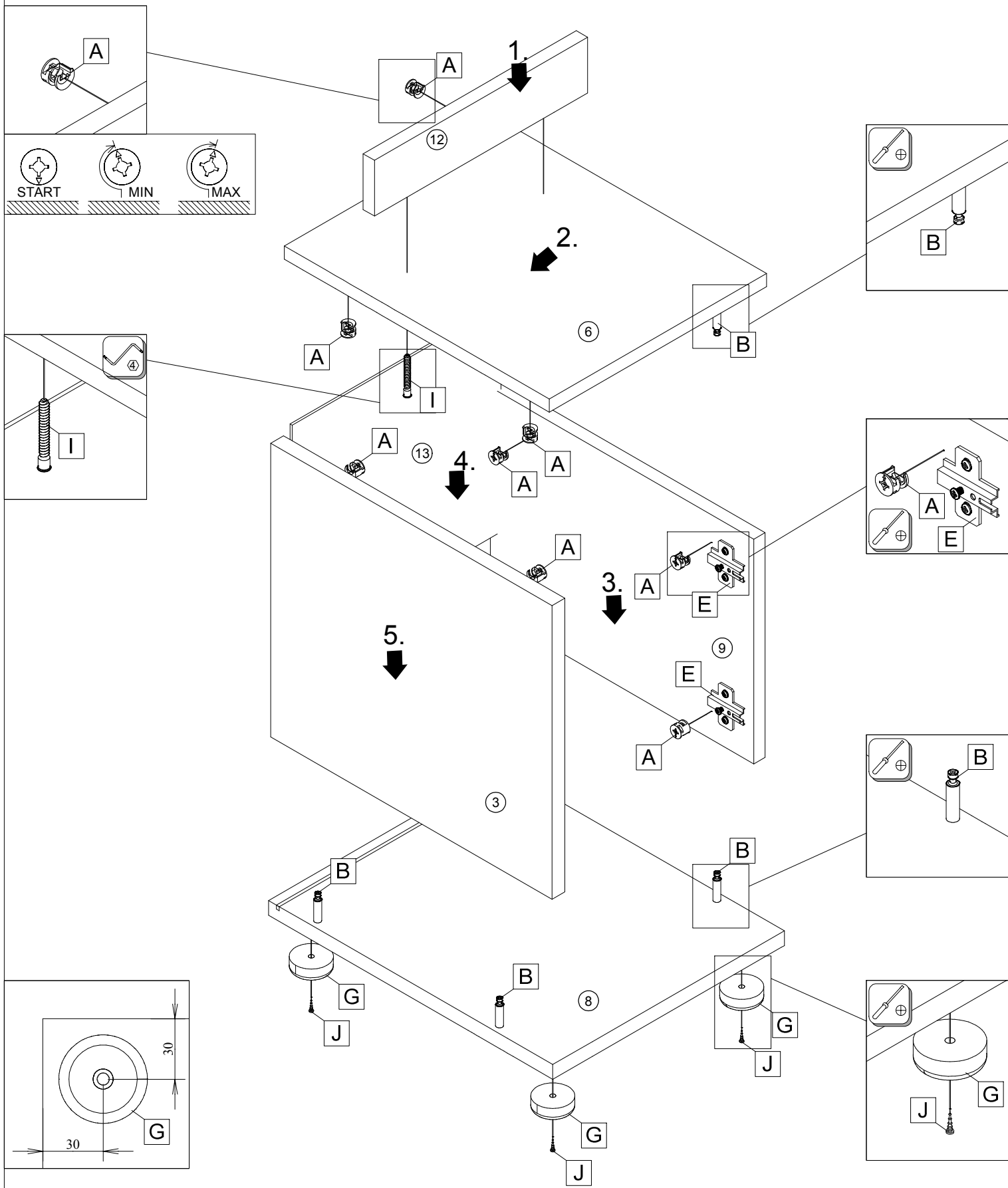

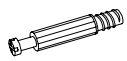





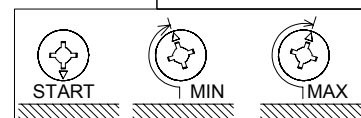
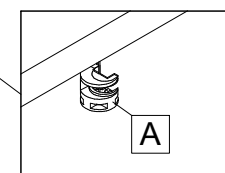
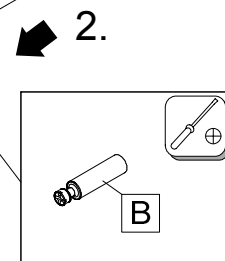
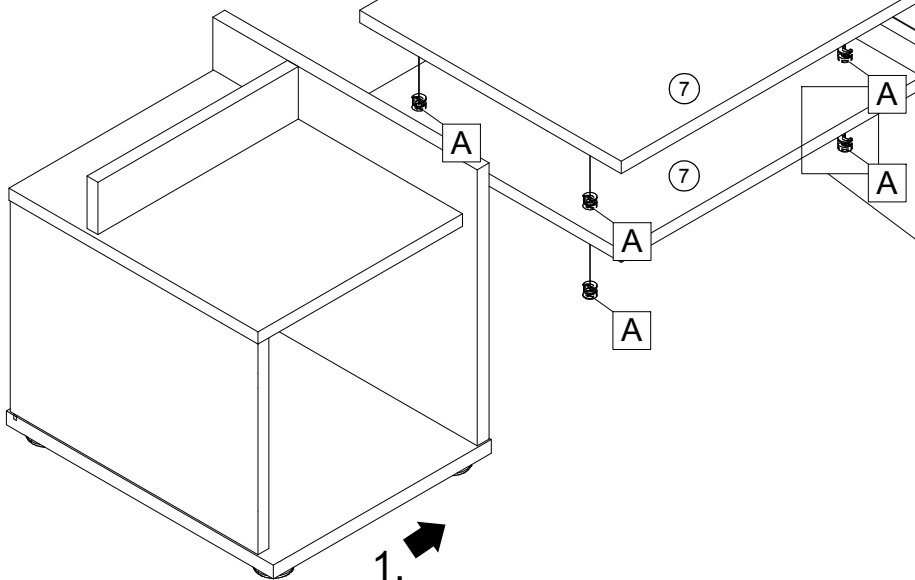
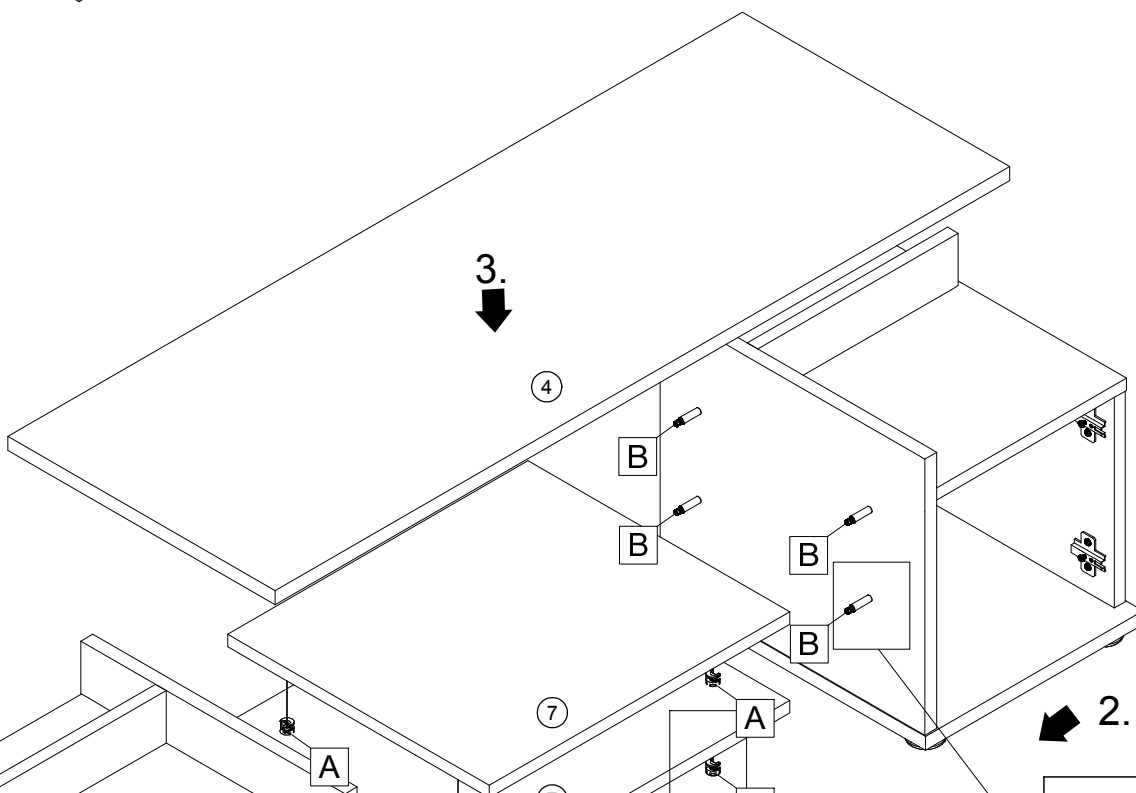
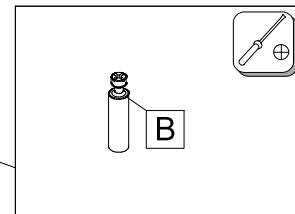
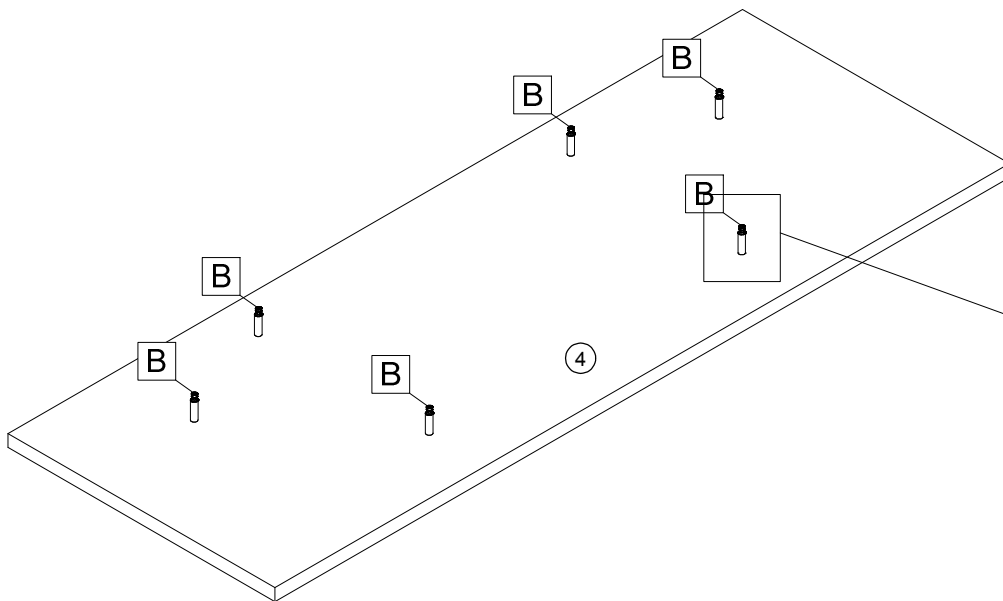

A 8x

B 14x



					
C 2x	D 4x	F 8x	H 30x	K 4x	L 2x

