

Art.-Nr.  
15550073/03  
15550073/04

# FLO 2

	650	mm
	1760	
	342	



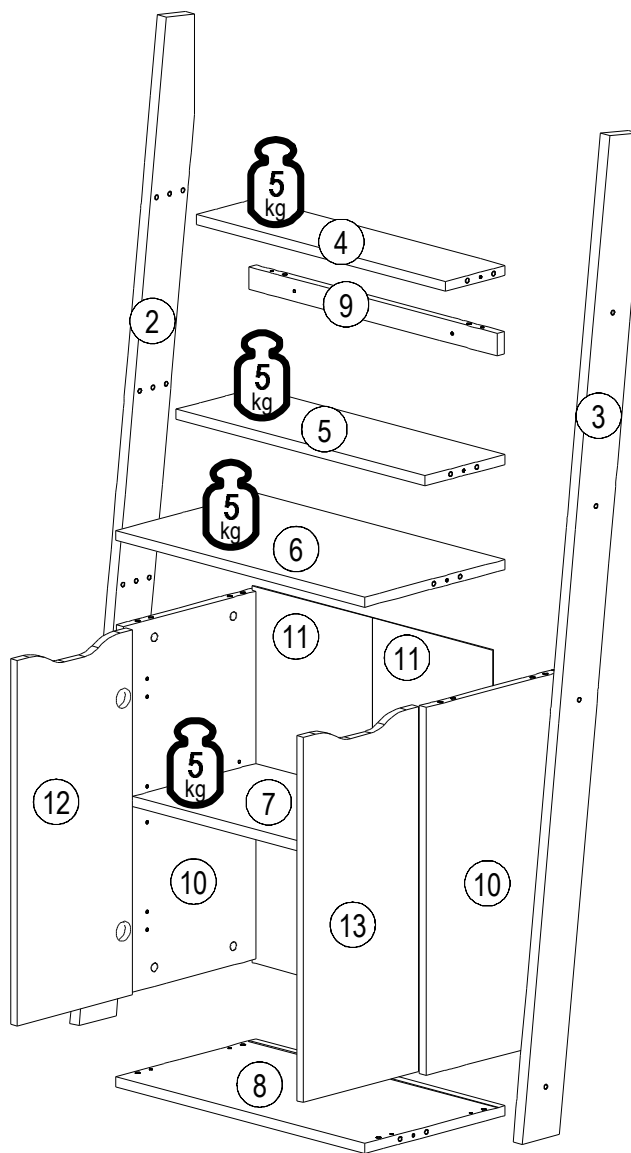
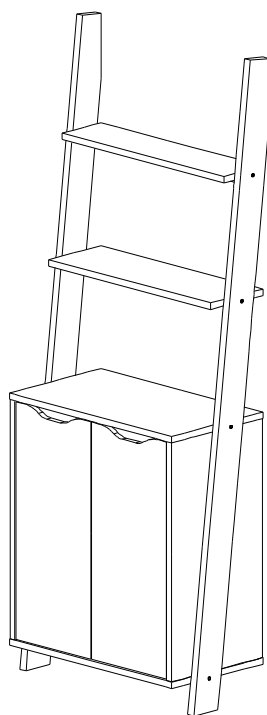

	40min		≤ 0,5 kg	3m	PZ 2	4	300 mm	
--	-------	--	----------	----	------	---	--------	--

ID	ID	Icon	Dimensions	Quantity	Unit
13630	②		1772*90*22	1x	1/2
13631	③		1772*90*22	1x	1/2
13613	④		606*146*18	1x	1/2
13614	⑤		606*195*18	1x	1/2
13624	⑥		606*342*18	1x	1/2
13625	⑦		568*300*18	1x	1/2
13617	⑧		606*342*18	1x	1/2
13618	⑨		604*40*18	1x	1/2
13626	⑩		657*340*18	2x	2/2
13627	⑪		673*292*2,5	2x	2/2
13628	⑫		651*280*16	1x	2/2
13629	⑬		651*280*16	1x	2/2

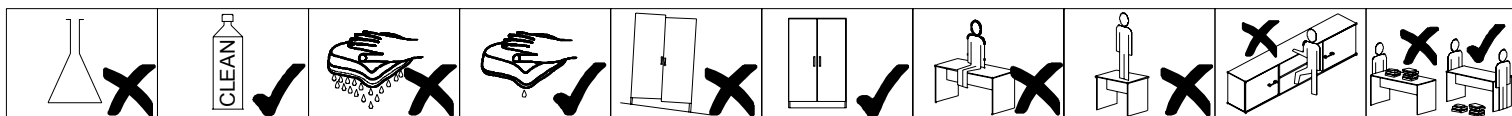

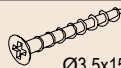
22248.00		Ø4x40	24103.00		Ø8	27000.00		Ø8x30	22300.00		Ø7x50	22800.01		4		Ø4x70	22213.00		Ø3.5x15	35101.01		4x
A	2x	B	2x	C	26x	D	8x	E	1x	F	8x	G	2x	H	8x	J	4x					
8402.03		50553.00		70013.01		Ø15x13	70021.01		8x		8x	36001.01		4x	36001.01		4x					
K	2x	L	8x	M	8x	N	8x	P	8x	Q	4x	R	4x									

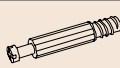

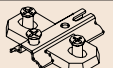
						
C 26x	H 8x	J 4x	M 8x	N 8x	Q 4x	R 4x

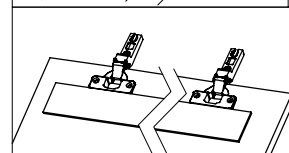
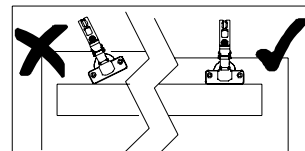
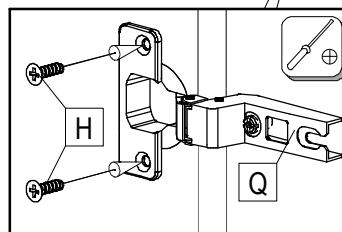
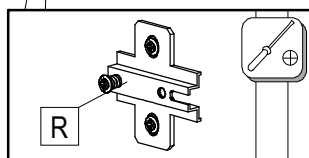
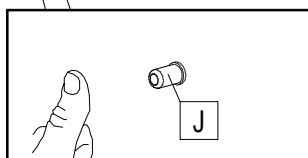
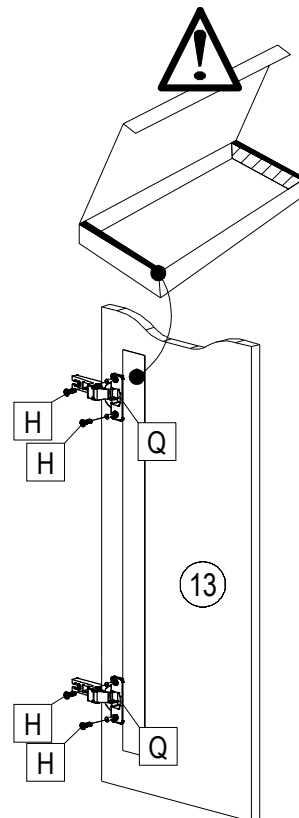
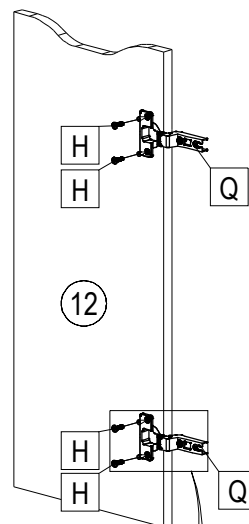
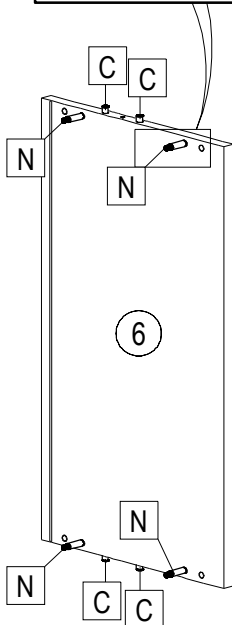
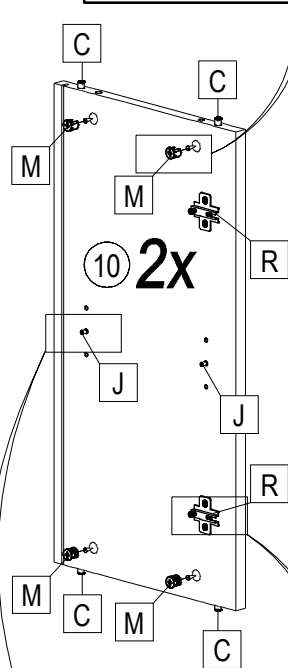
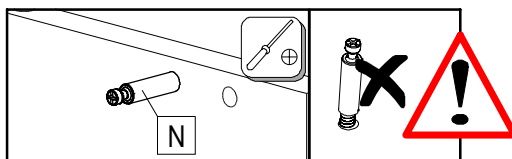
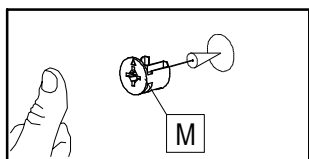
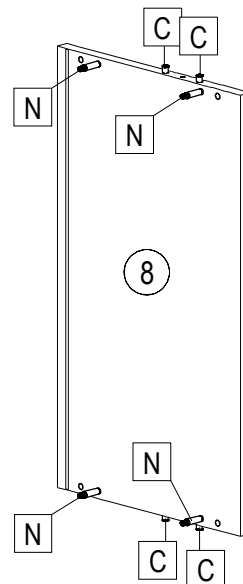
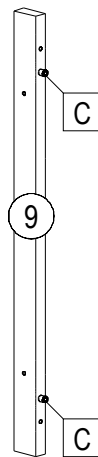
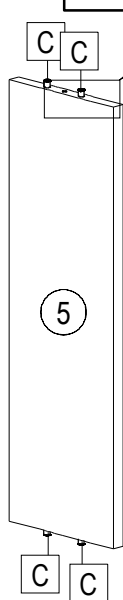
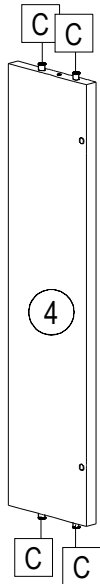
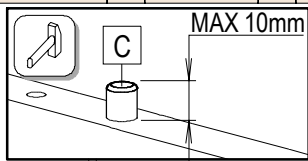

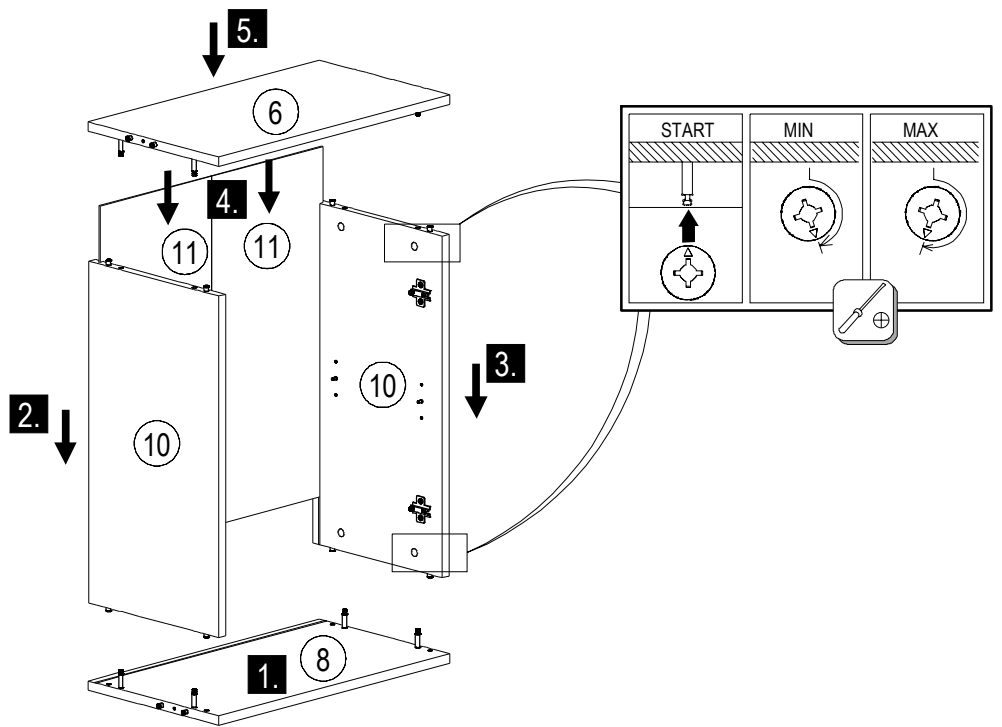
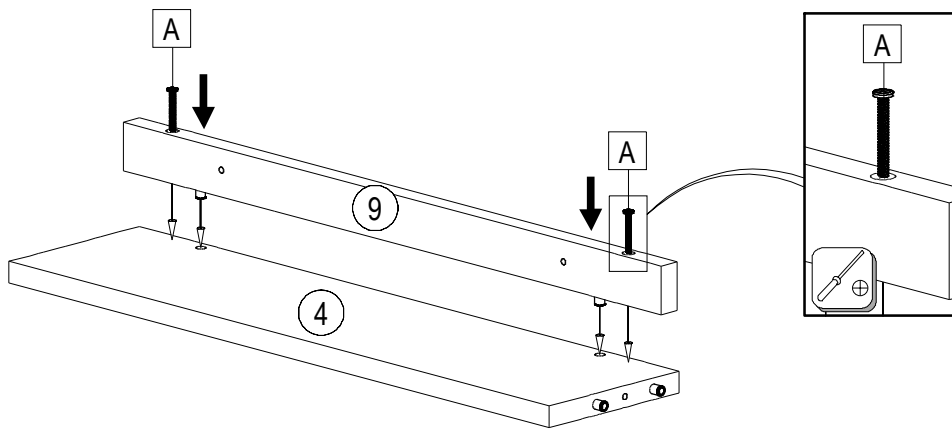

	
Ø4x40	
A	2x

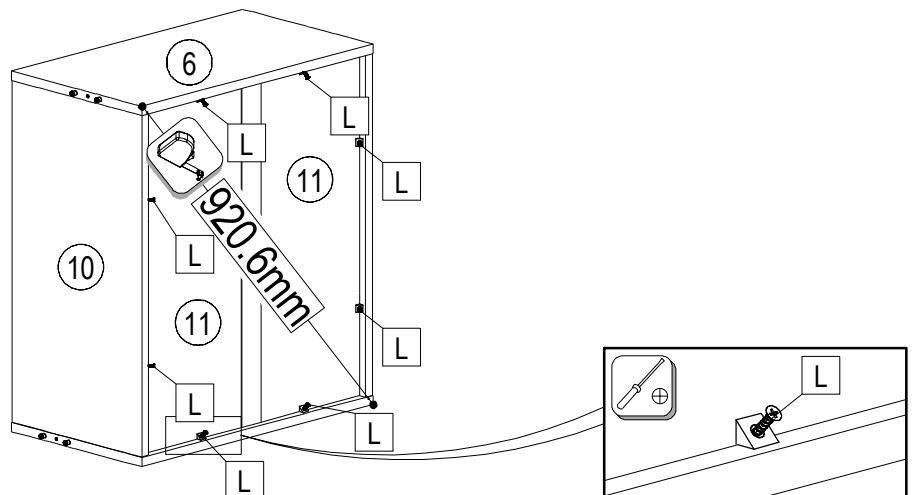

	
L	8x

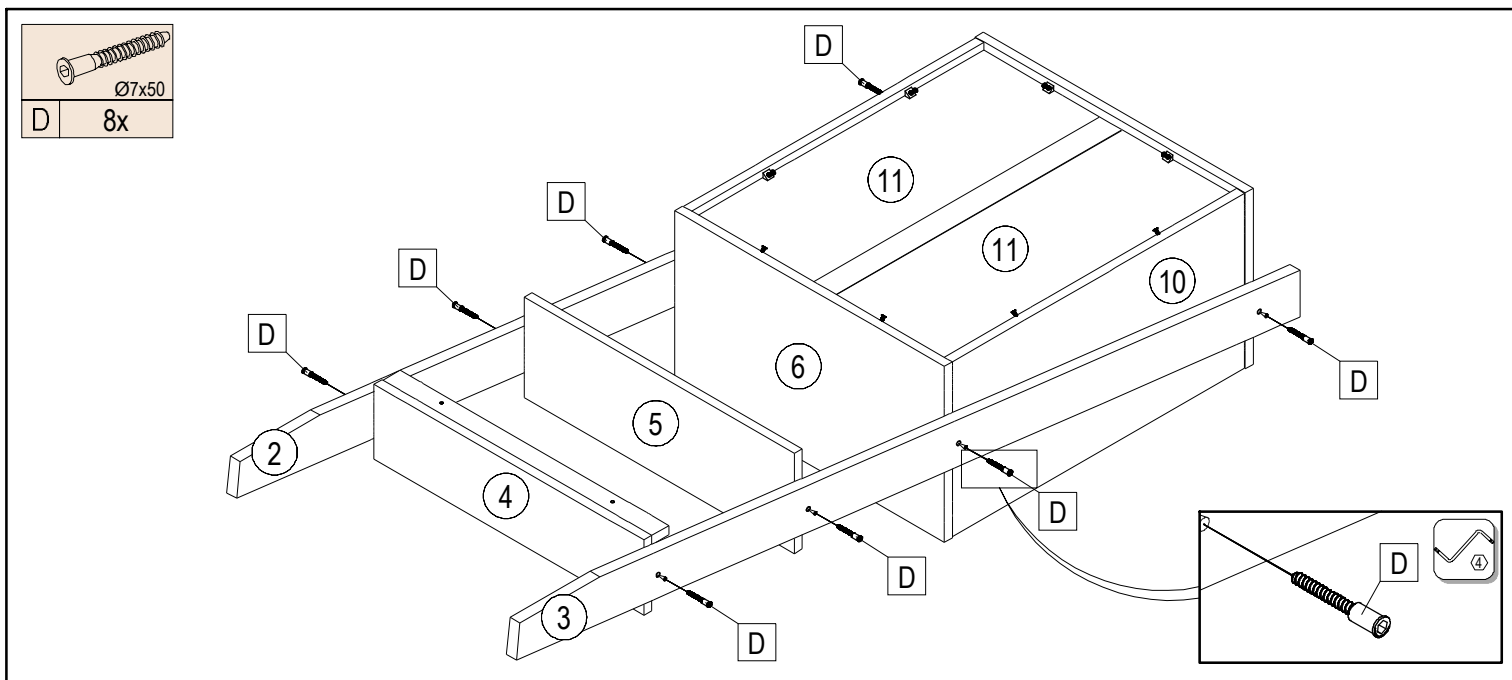
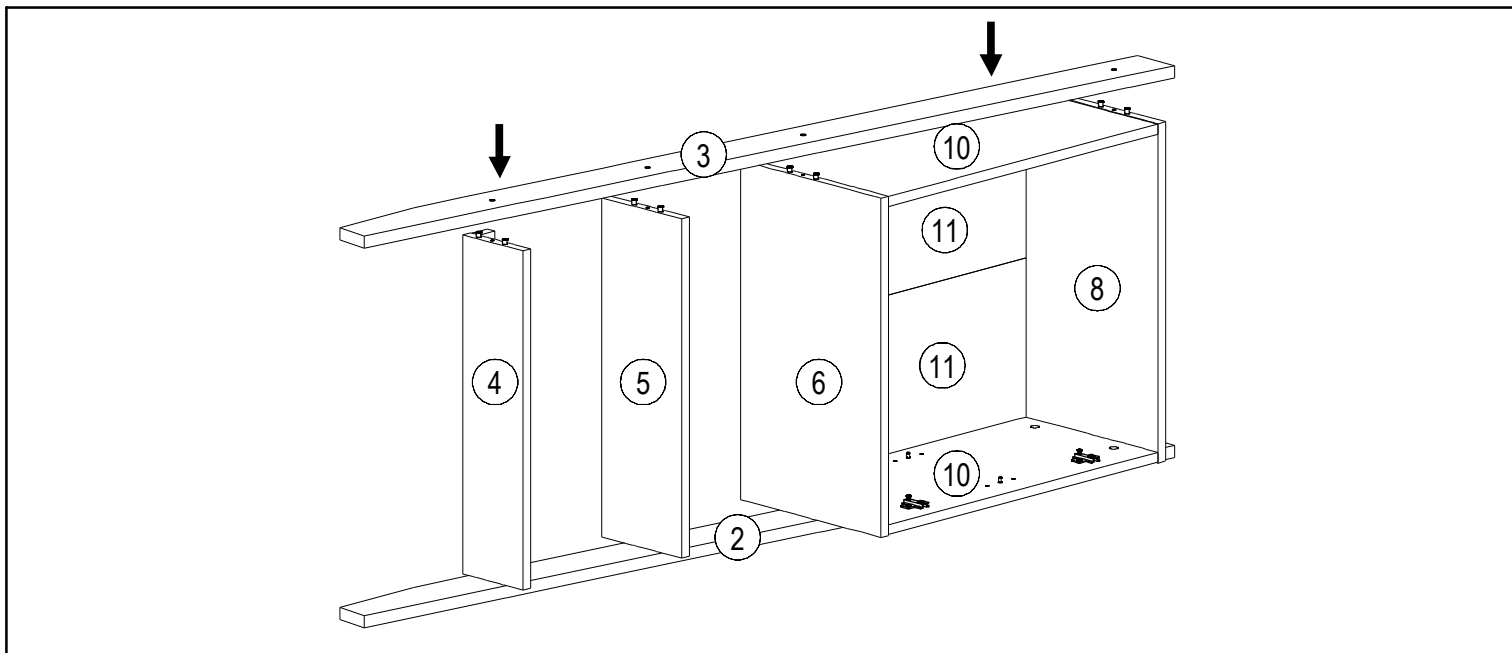
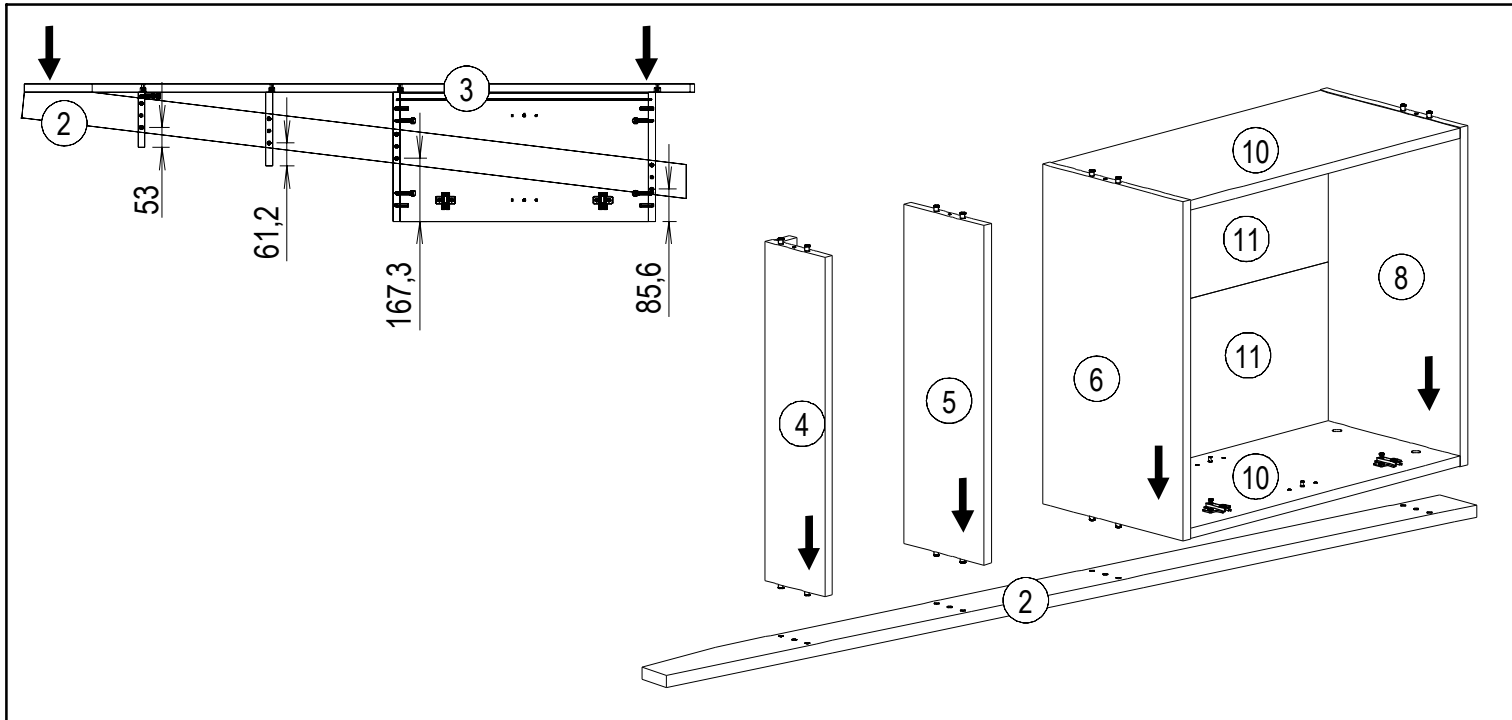

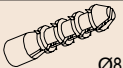

	Ø8		Ø4x70
B	2x	G	2x

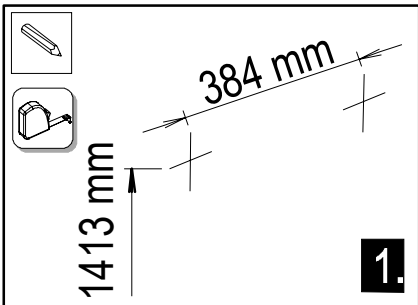
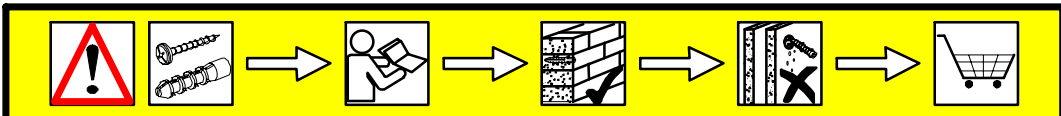

**Achtung!** Die Wandbeschaffenheit ist vor der Montage unbedingt zu prüfen. Die beigelegten Universaldübel sind ausschließlich nur zur Verwendung für festes Mauerwerk wie Beton/Ziegel. Die Mauerdübel dürfen nicht bei Mauerwerk wie Hohlraumziegel, Leichtbausteinen, Gipskartonplatte oder anderer Rahmenbauweise verwendet werden. Bei diesen Mauerwerken sind gegebenenfalls Spezialdübel zu verwenden! Diese sind in einem Fachgeschäft (Baumarkt) erhältlich. Bei Nichteinhaltung wird seitens Produzenten/Händler und Importeur keine Haftung übernommen.

**Caution!** The wall must be examined before assembly. The included universal wall plugs are only suitable for using in firm masonry such as concrete block or brick. Do not use the wall plugs masonry such as hollow brick, lightweight block, surfaces such as gypsum plasterboard or other framing systems. If applicable, particular wall plugs must be used! These are available at a specialised store (hardware store). In case of non-compliance, the manufacturer/retailer or importer do not assume liability.

**Vigyázat!** Szerelés előtt a falfelületet feltétlenül vizsgálgja meg. A mellékelt univerzális tipli kizárólag stabil falazathoz használható mint például beton/tégla. A fal tipli nem használható könnyű építőkövekhez, üreg tégla, gipszkarton lapokhoz vagy más favázás építményekhez. Ezekhez a falfelületekhez csak speciális tiplik használhatóak, melyek szaküzletekben (barkácsáruházakban) beszerezhetőek. Fentiek figyelmen kívül hagyása esetén a gyártó/kereskedő vagy forgalmazó nem vállal felelősséget.

**Upozornenie!** Pevnosť steny sa musí pred montážou bezpodmienečne skontrolovať. Univerzálne hmoždenky, ktoré sú obsiahnuté v balení, používajte jedine pre pevné murivo ako je betón/tehla. Hmoždenky sa nesmú používať v prípade ľahkého stavebného muriva, dutina tehla, u sádrokartónových dosiek alebo iných konštrukcií rámu. U týchto murív je nutné použiť špeciálne hmoždenky! Tieto je možné dostať v špeciálnych predajniach so stavebným materiálom (stavebniny). Pri nedodržaní pokynov nepreberajú výrobcovia/predajci a dodávateľa zodpovednosť za vzniknuté škody.

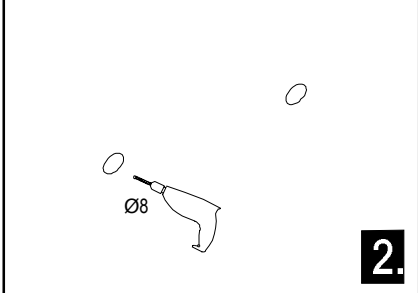





**OBS!** Våggens sammansättning ska absolut kontrolleras innan montering. De bifogade pluggarna får endast användas för stabila och fasta väggar, som t.ex. betong/tegel. De får absolut inte användas för kaviteter, väggar ur fonolit, gipsskivor eller dylikt. För dessa väggar måste det användas speciella pluggar, som finns att köpa i specialiserad handel (byggmarknad). Varken tillverkare, handlare eller importör övertar ansvar, om dessa anvisningar inte följs.

**Upozornění!** Před montáží je nutné zkontrolovat stav stěny. Přiložené univerzální hmoždinky jsou určeny pouze k použití pro pevné zdivo jako beton/cihly. Hmoždinky do zdi se nesmí používat u dutinová cihla, zdiva jako pórovitý stavební kámen, sádrokartónová deska nebo jiný měkký materiál. U těchto zdív jsou nutné použít speciální hmoždinky! Jsou k dostání v speciálních prodejních se stavebním materiálem. Při nedodržení těchto pokynů výrobce/prodejce a dovozce neručí za způsobené škody.

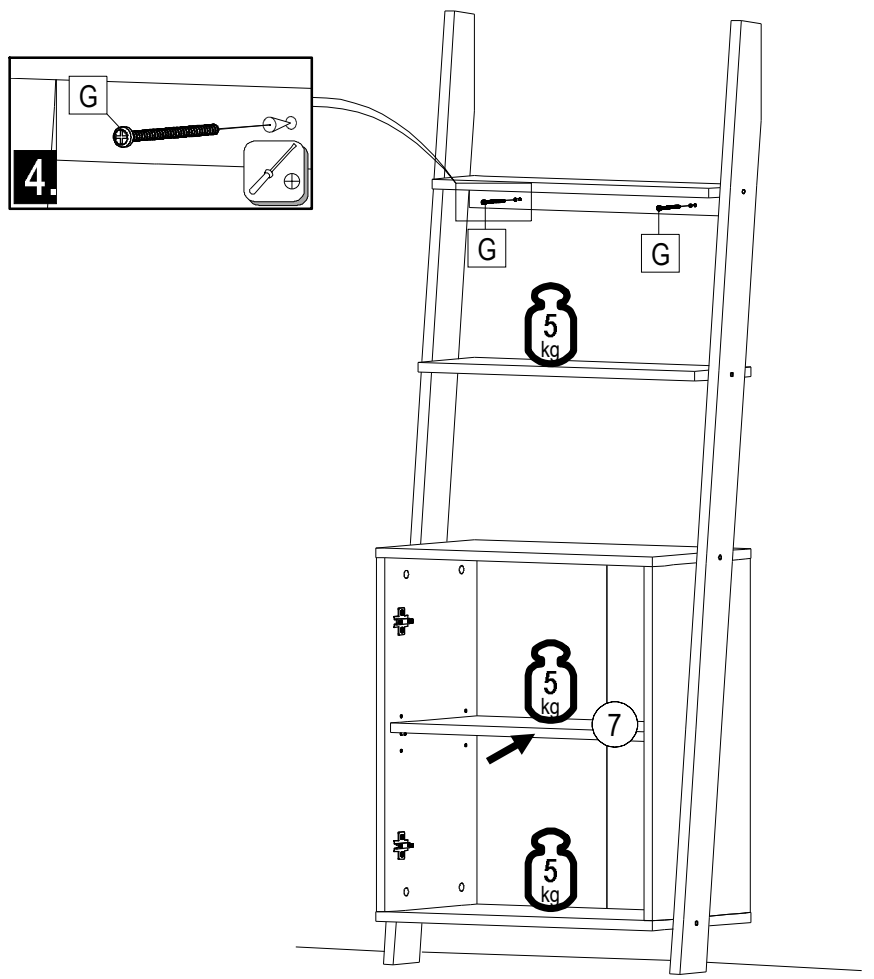
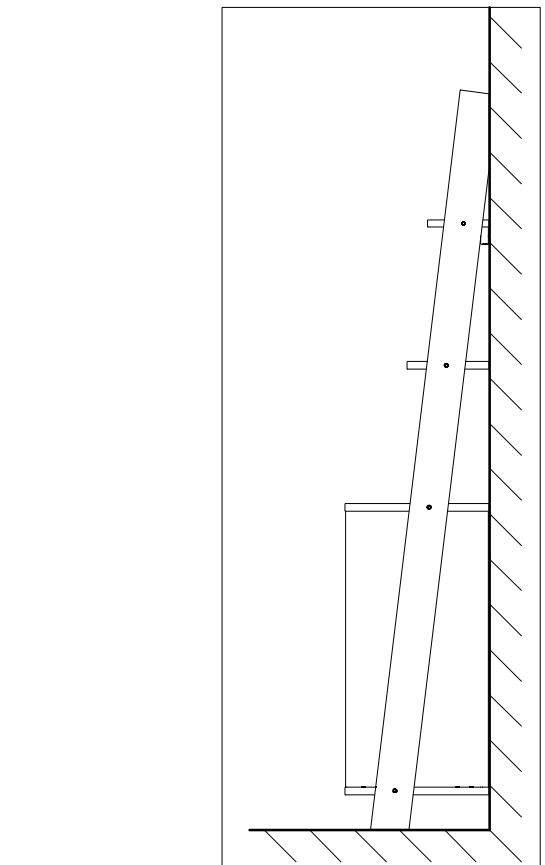
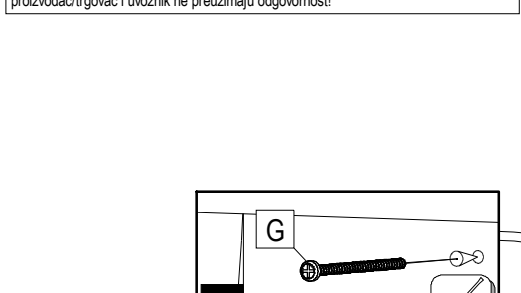
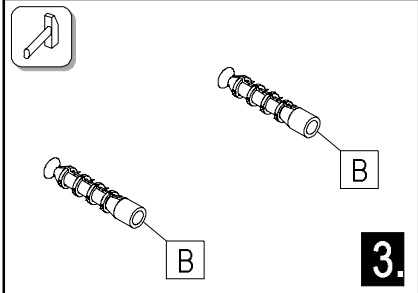
**Paznja!** Prije montaže obavezno provjerite svojstvo zida. Priložene univerzalne tiplje namijenjene su isključivo za masivne zidove od betona/opeke. Tiplje za masivne zidove ne smiju se koristiti za zidove kao npr šupljina opeka laki sastavni elementi, gips-kartonske ploče ili drugi modularni načini gradnje. Za te zidove potrebne su eventualno specijalne tiplje! Iste su dostupne u specijaliziranim trgovinama građevinskim materijalom. U slučaju nepridržavanja prethodno navedenih napomena, proizvođač/trgovac i uvoznik ne preuzimaju odgovornost!

**Pozor!** Pred montažo preventivno stanje stene. Priloženi univerzalni mozniki so izključno samo za uporabo na čvrstem zidovju, kot sta beton in opeka. Stenski mozniki se ne smejo uporabljati pri zidovju kot so votlino opeke, zidaki za lahko gradnjo, mavčne plošče ali druge okvirne gradnje. Pri teh zidovjih morate v danih primerih uporabljati posebne moznike. Ti so na voljo v specializiranih trgovinah (trgovinah z gradbenim materialom) Pri upoštevanju se s strani proizvajalca/trgovca in uvoznika ne prevzame jamstvo.



		
F 8x	K 2x	P 8x

