

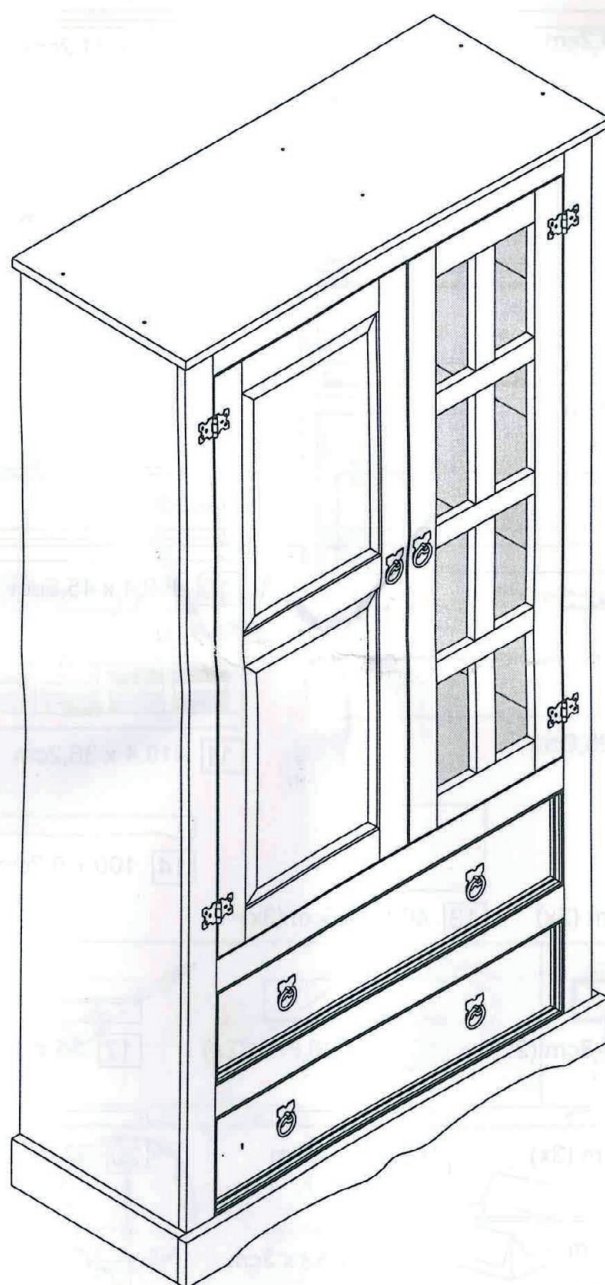

# Montageanleitung 19001-02



D

Sicherheitshinweise

GB

Safety information

NL

Veiligheidsvoorschriften

PL

Wskazówki dotyczące bezpieczeństwa

TR

Güvenlik bilgileri

RU













Правила техники безопасности





Bitte lesen Sie diese Aufbauanleitung sorgfältig. Entfernen Sie aus dem Karton alle Verpackungsmaterialien, Heftklammern und Verpackungsbänder.





Vergleichen Sie alle Teile mit der nachstehenden Artikelliste: alles soll vorhanden sein. Bitte legen Sie alle Teile auf eine flache, saubere und weiche Oberfläche um jegliche Kratzer zu vermeiden. Sämtliche Verpackungsteile sollten umweltfreundlich entsorgt werden.



**Beginnen Sie mit dem Testziehen der Schrauben auf der Mitte der Platte und dann erst nach außen hin langsam und der Reihe nach über Kreuz festziehen.**

**BITTE NICHT ZU FEST ANZIEHEN.** Lieber nach einiger Zeit des Gebrauchs nachziehen.





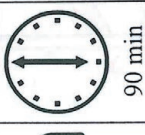
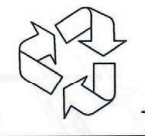

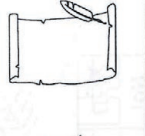

 A x 40 Ø8x30mm	 B x 42 Ø3,5x14mm	 C x 23 Ø3,5x30mm	 D x 44 Ø4,0x35mm	 E x 8 Ø4,0x40mm	 F x 8 Ø4,5x50mm	 G x 6 Ø5x19mm	 H x 6	 J x 4	 K x 4 Ka Kb	 L x 8	 M x 46
---	--	---	---	--	--	---	--	--	--	--	---

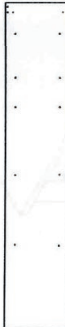
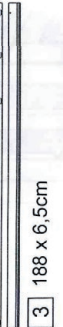
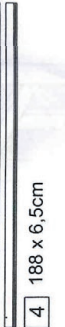
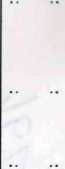
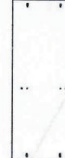
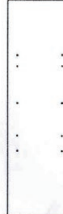
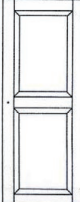

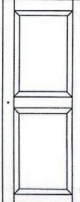

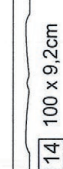
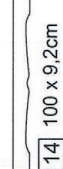
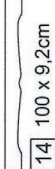
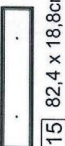
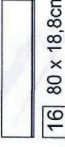
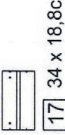
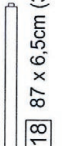
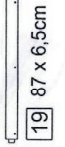
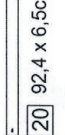
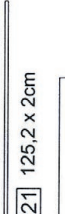
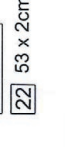
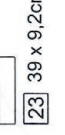
 1 188 x 38,2cm	 2 188 x 38,2cm	 3 188 x 6,5cm	 4 188 x 6,5cm	 5 100 x 41,2cm	 6 92,4 x 36,6cm	 7 125,6 x 36,6cm	 8 183,4 x 42,2cm	 9 183,4 x 25,6cm	 10 119,4 x 45,8cm	 11 119,4 x 36,2cm	 12 50 x 36cm (2x)	 13 40,5 x 36cm (3x)	 14 100 x 9,2cm	 15 82,4 x 18,8cm (2x)	 16 80 x 18,8cm (2x)	 17 34 x 18,8cm (4x)	 18 87 x 6,5cm (3x)	 19 87 x 6,5cm	 20 92,4 x 6,5cm	 21 125,2 x 2cm	 22 53 x 2cm	 23 39 x 9,2cm	 24 81 x 32,6cm (2x)	 25 35 x 5,5cm (4x)	 26 10 x 2cm (8x)
---	---	--	--	---	--	---	---	---	--	--	--	--	---	--	--	--	--	---	---	---	--	--	--	---	---

1

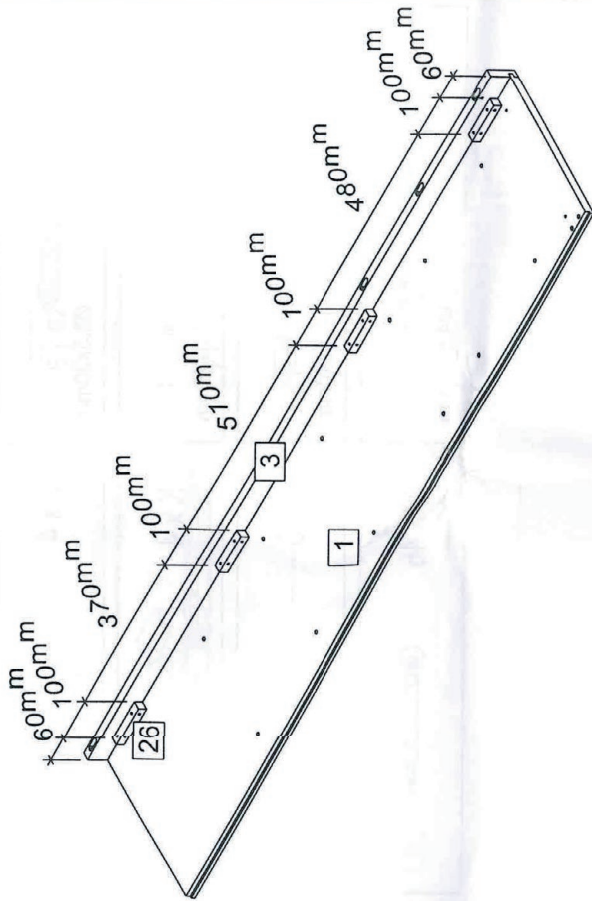
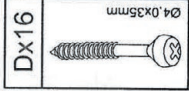

a:

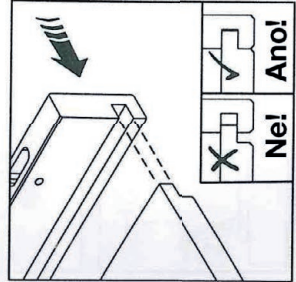

b:

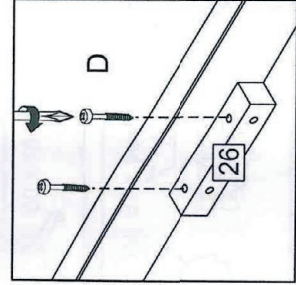

c:

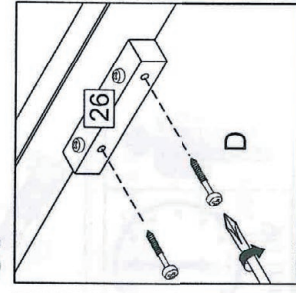

2

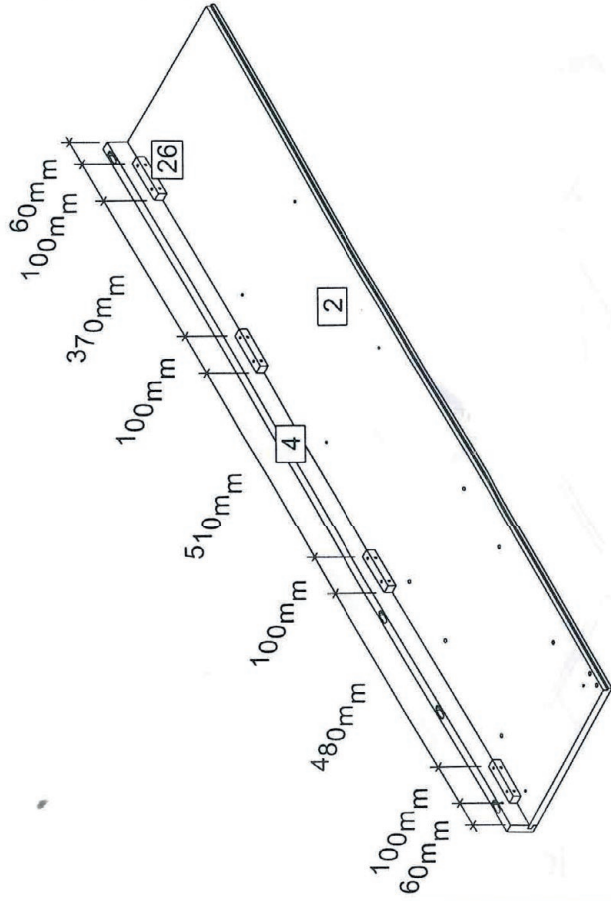
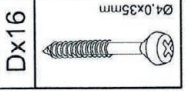

a:

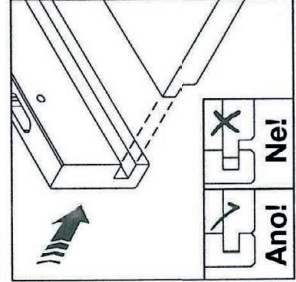

b:

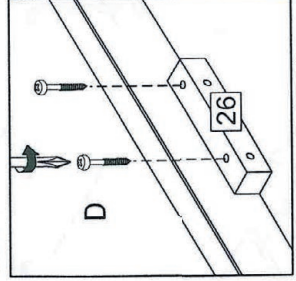

c:

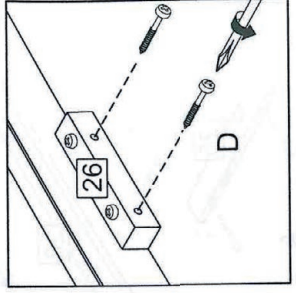

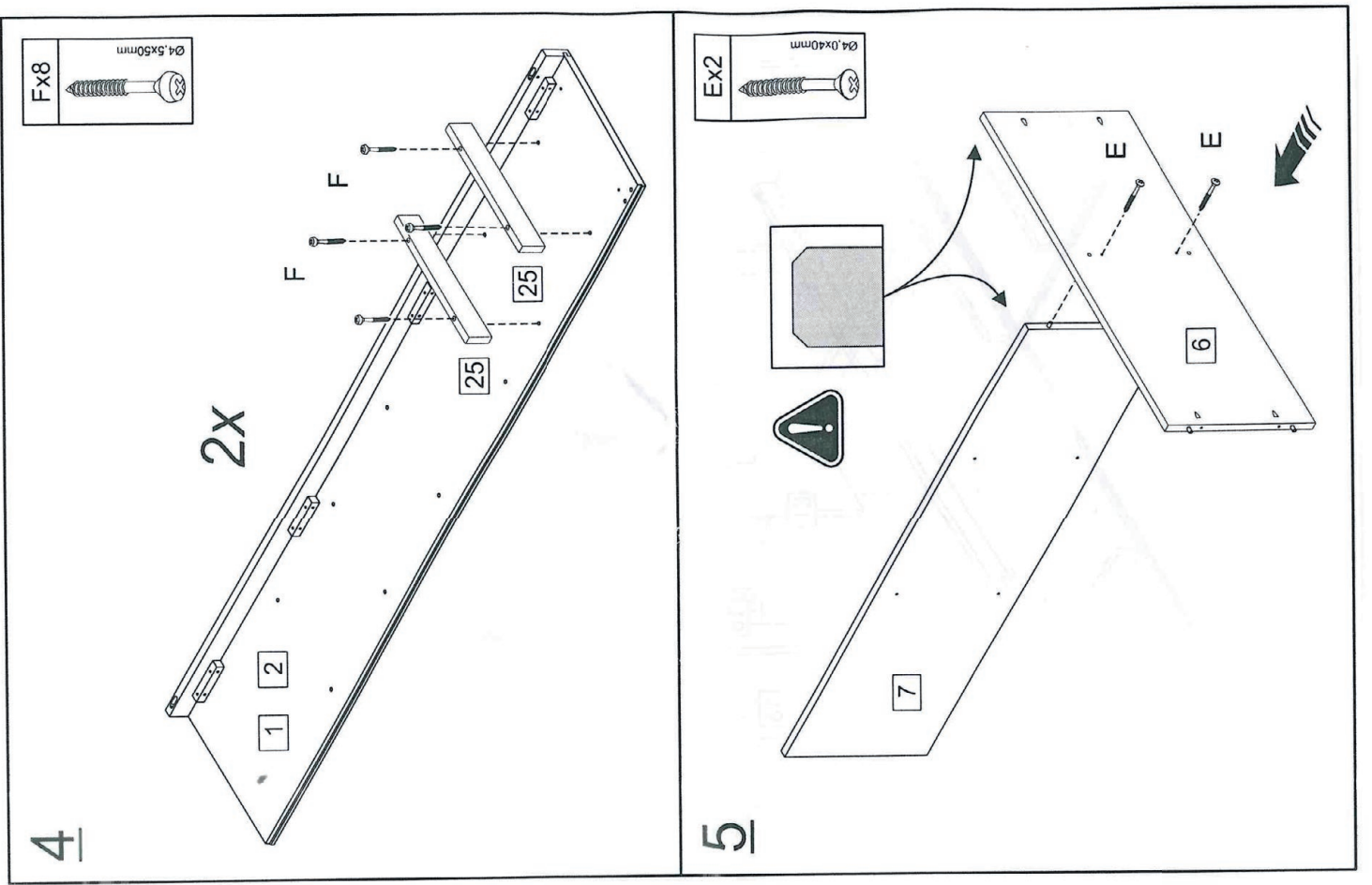
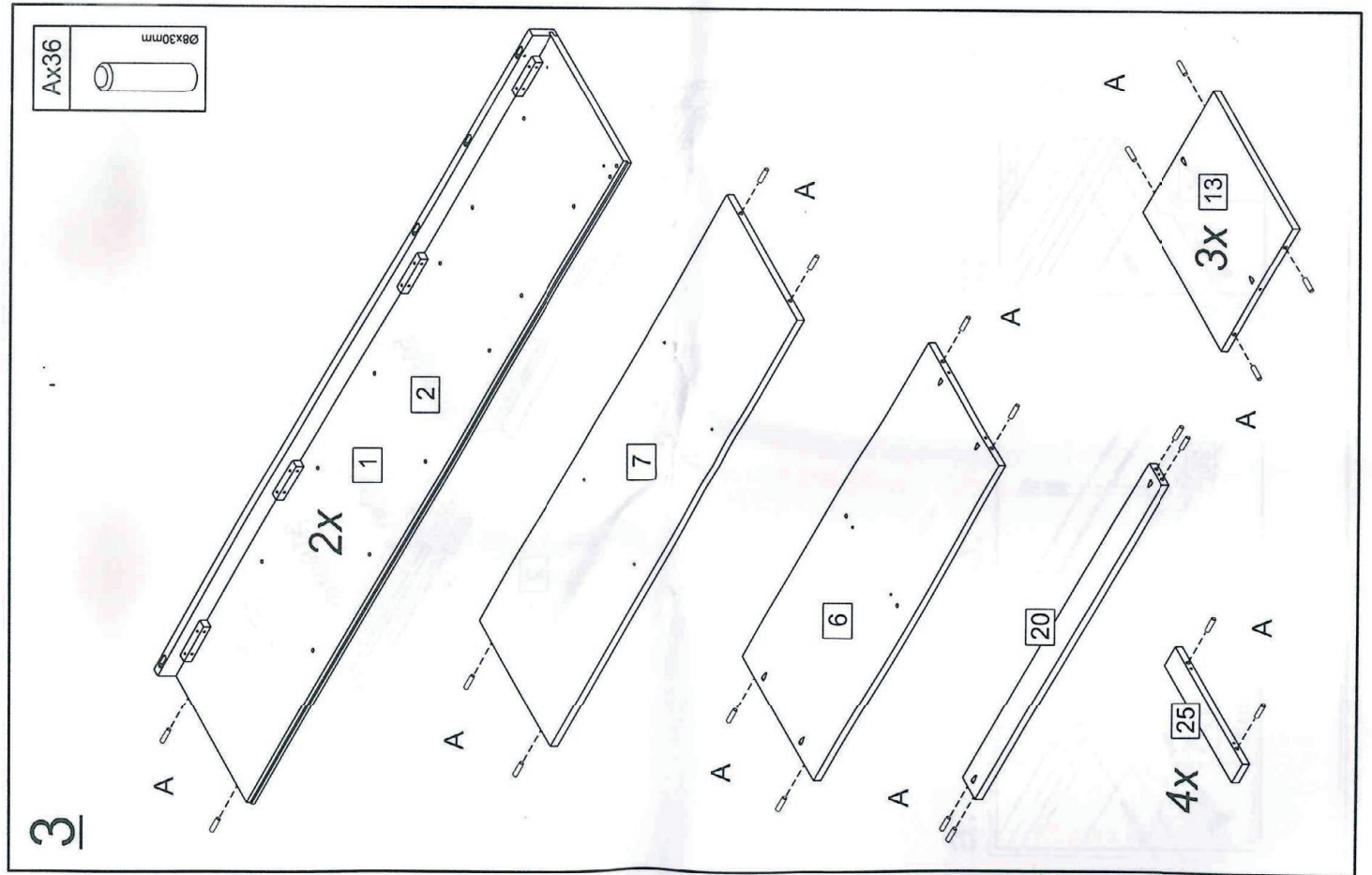

6

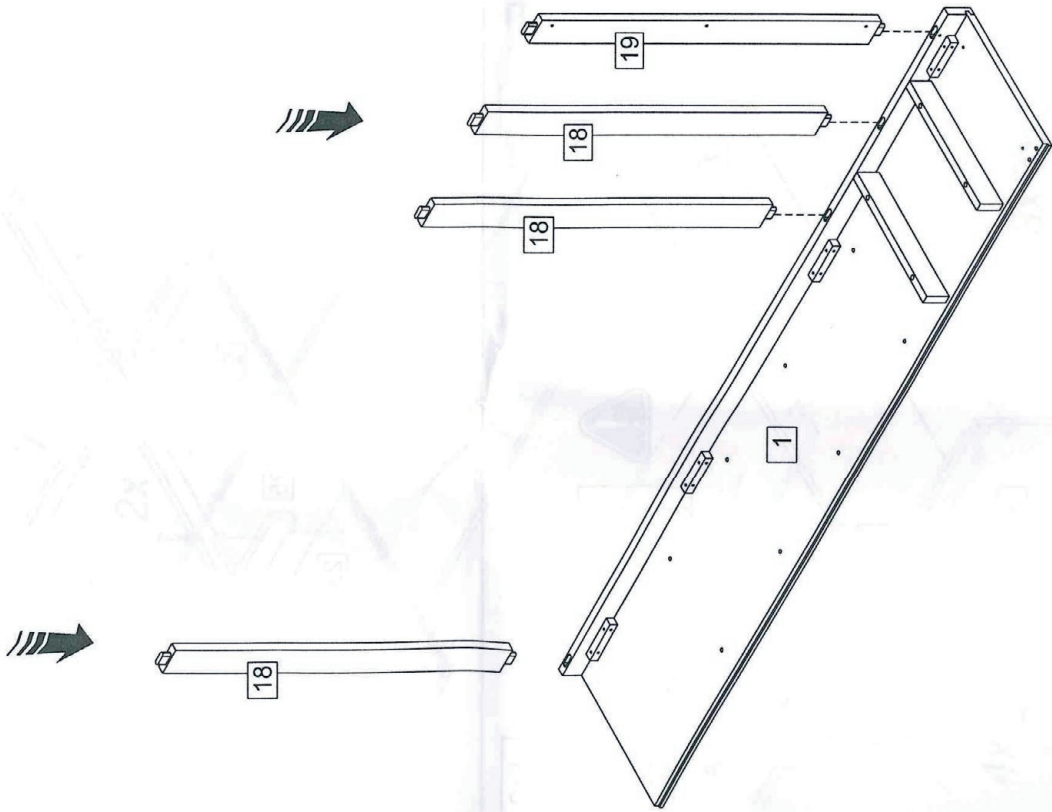

7

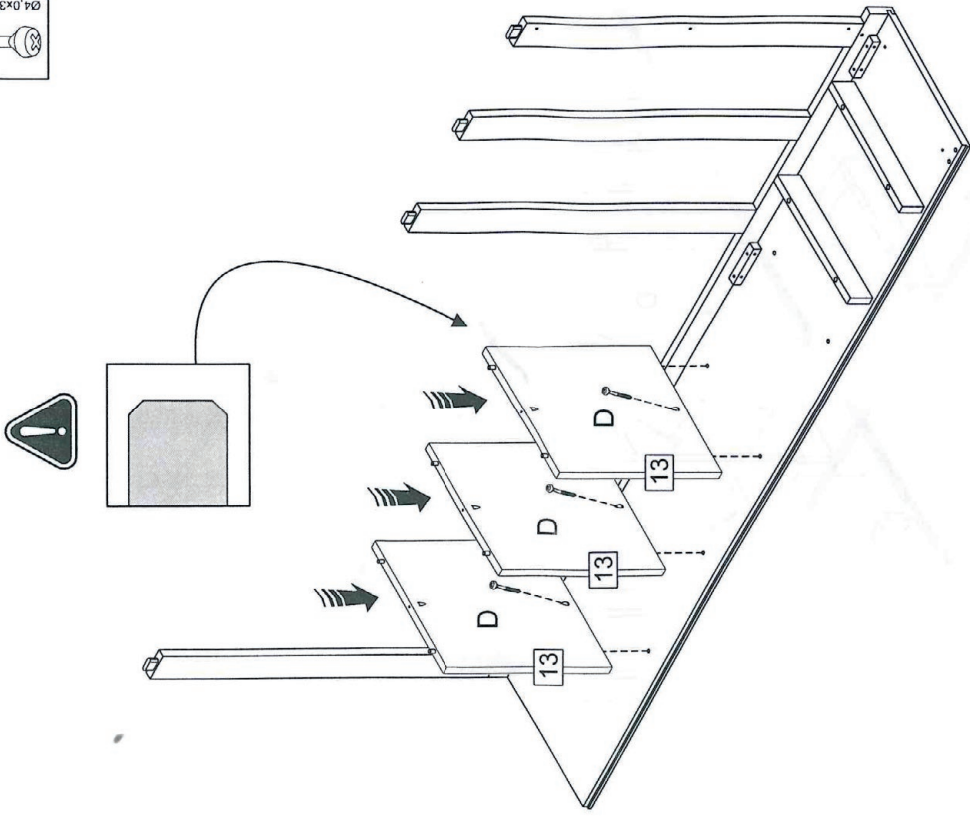

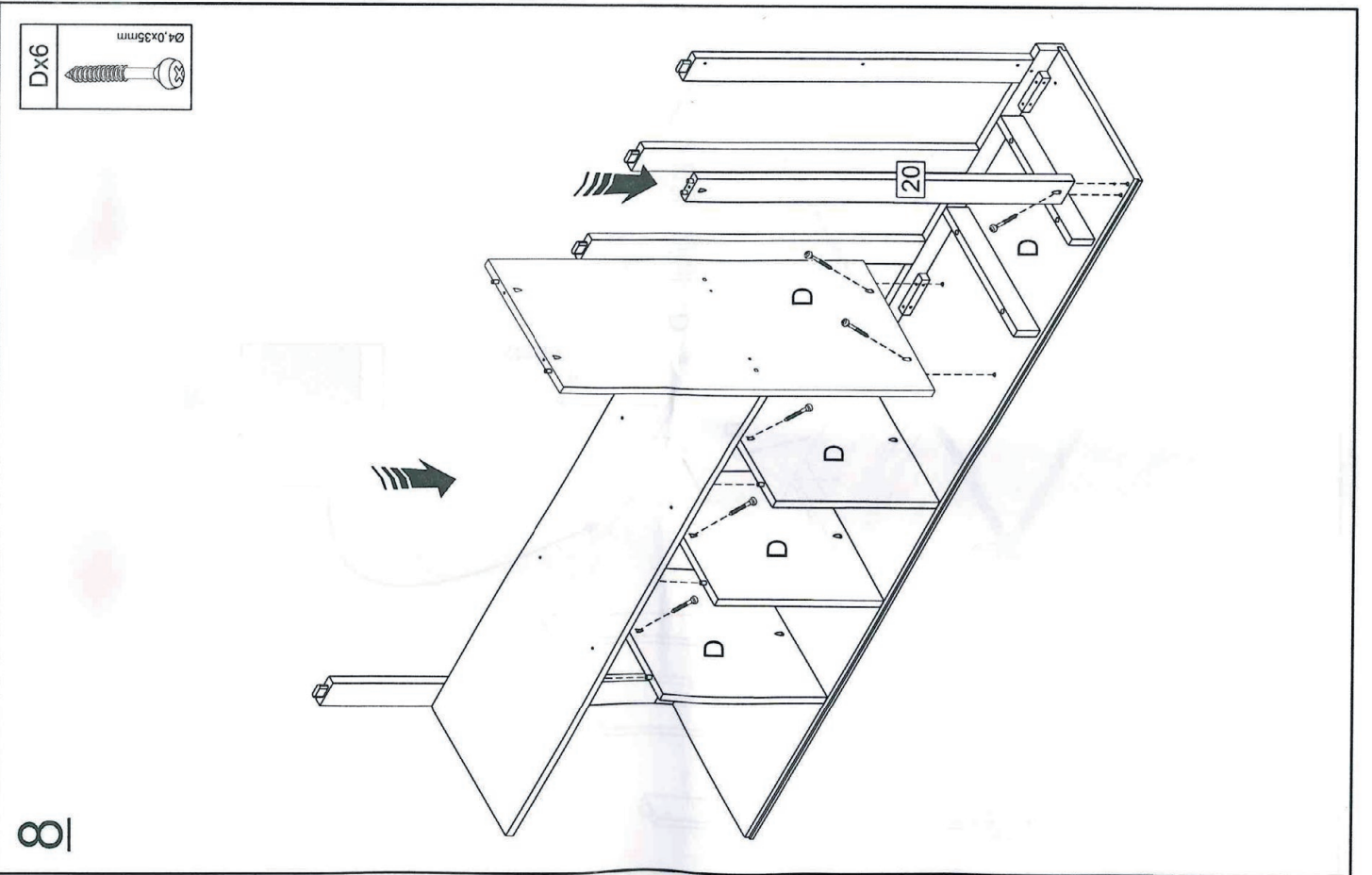
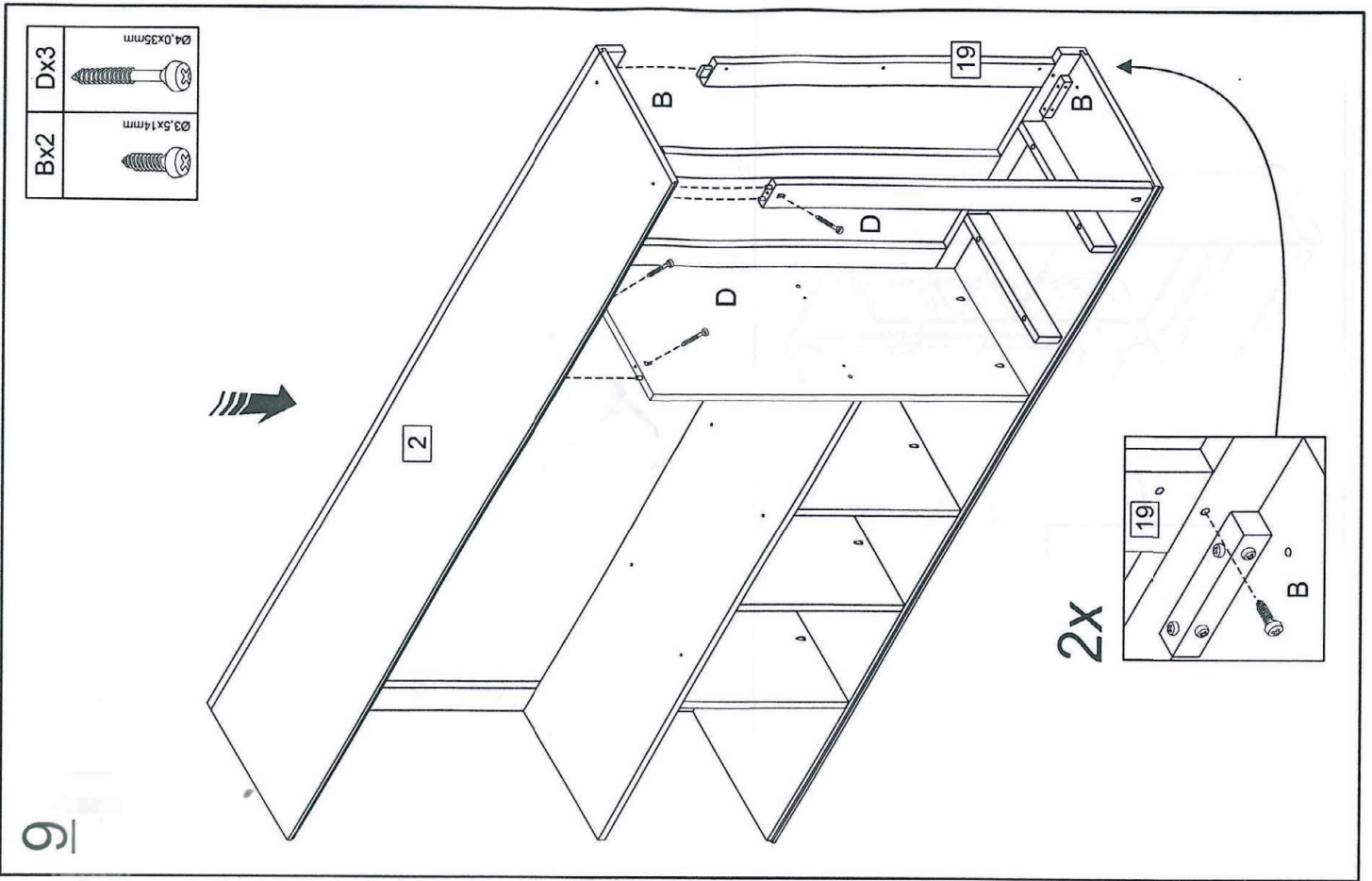

10

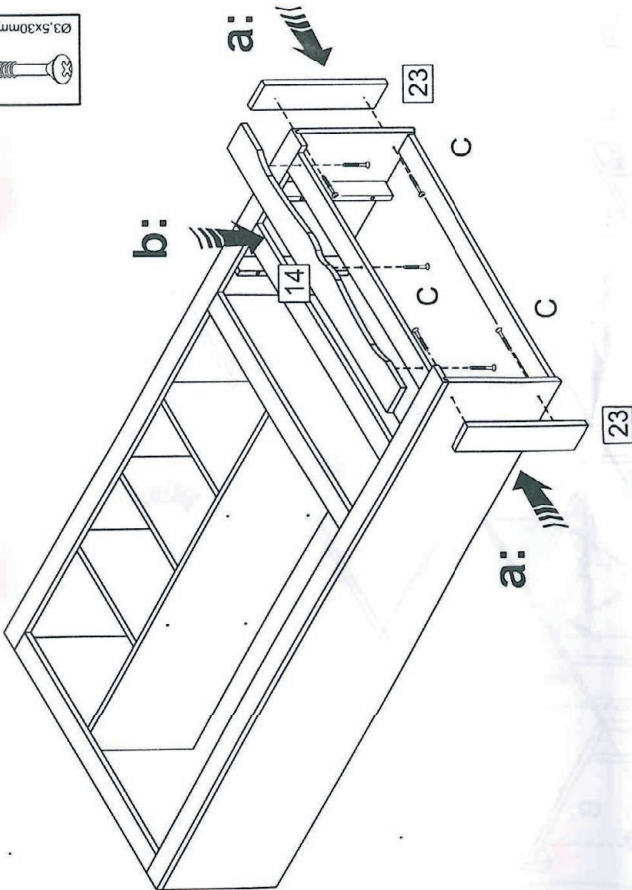
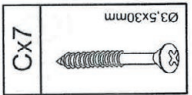

11

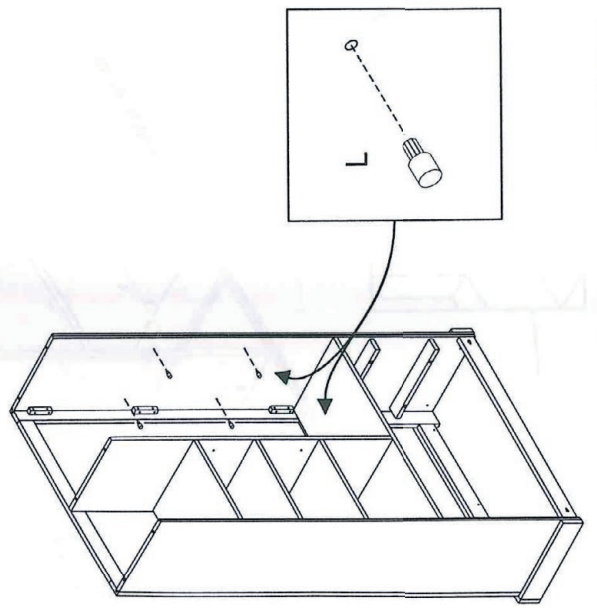
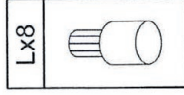

12

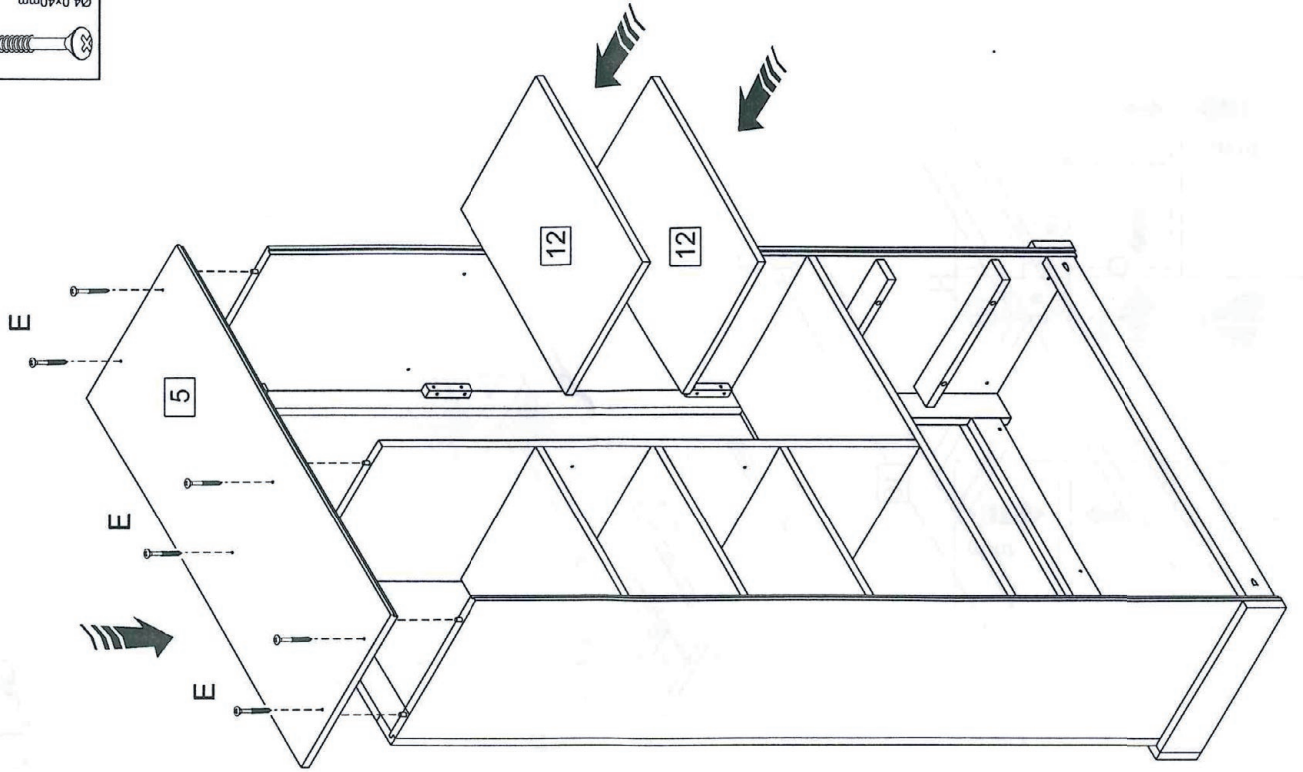
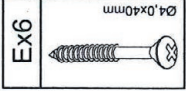

13

Bx12  
Ø3.5x14mm



Gx2  
Ø6x19mm



Hx2



Jx4

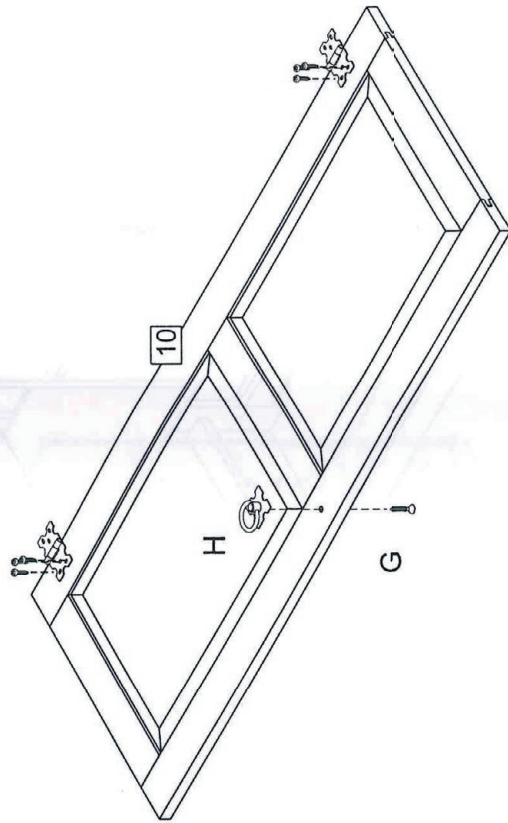
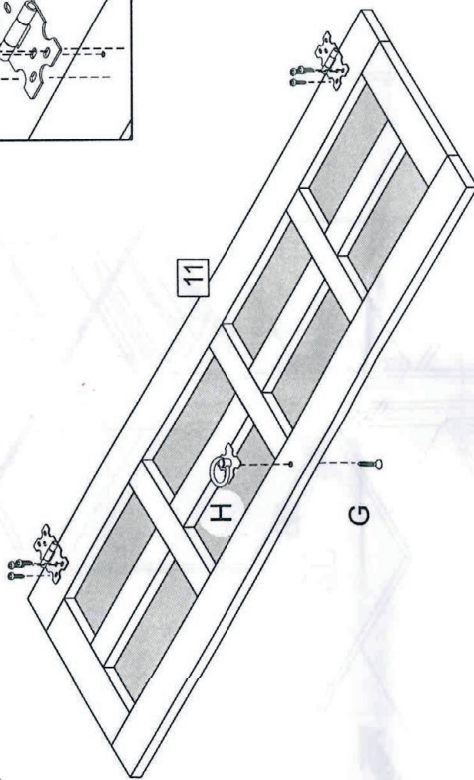
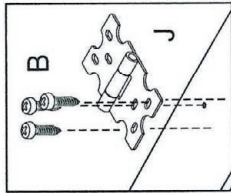

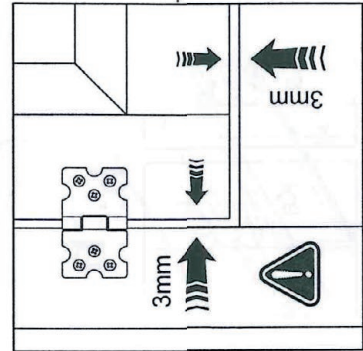
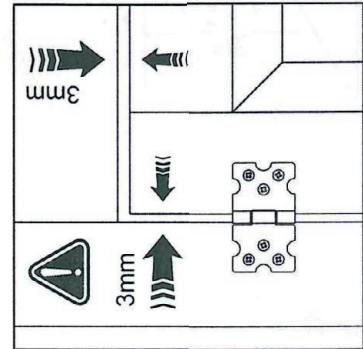
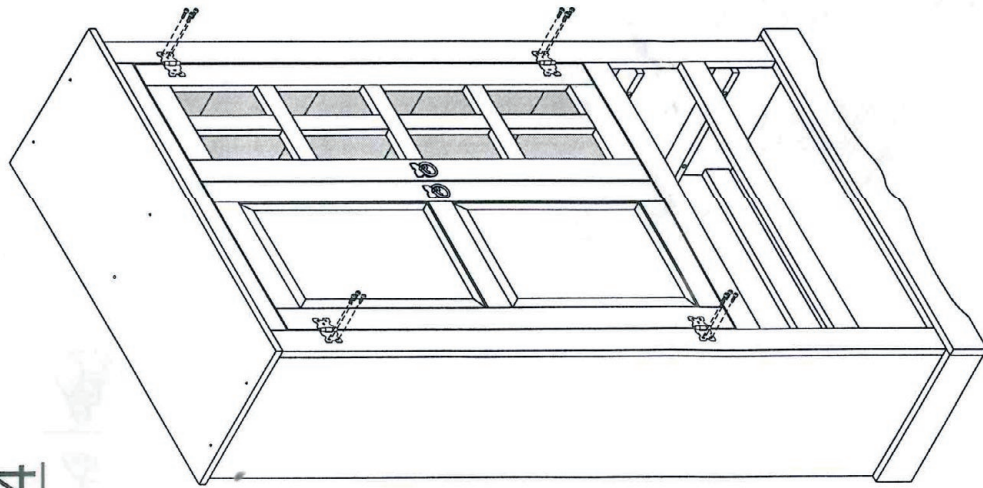
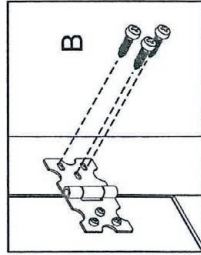

14

Bx12  
Ø3.5x14mm



15

Bx16	Kax4	Kbx4
		

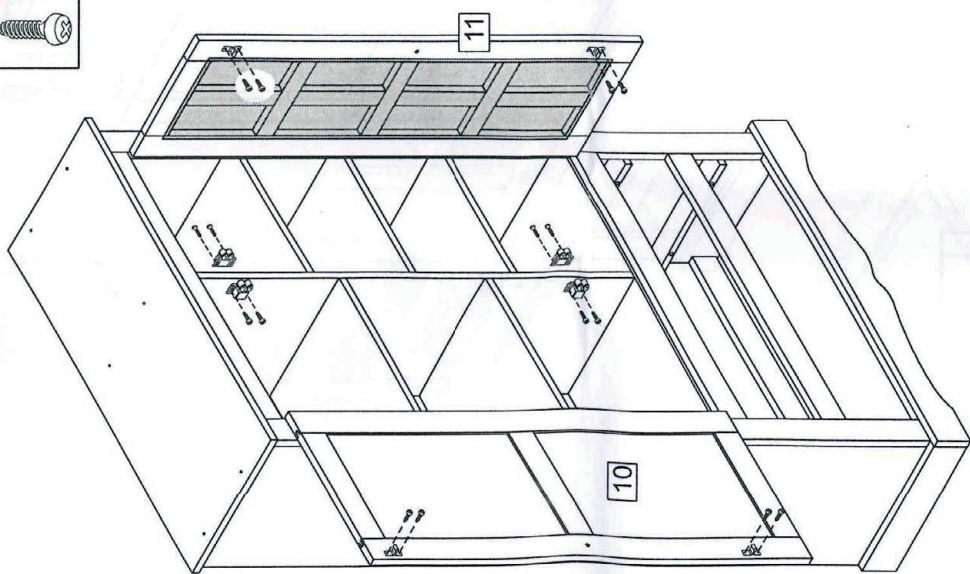

a:

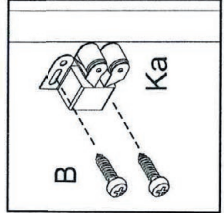

b:

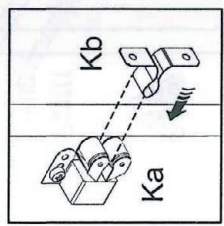

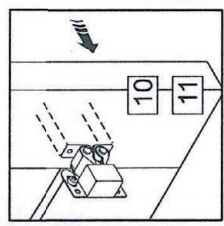

c:

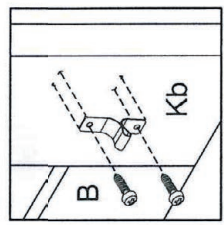

d:

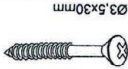

16

Cx16	Gx4	Hx4
		

2x

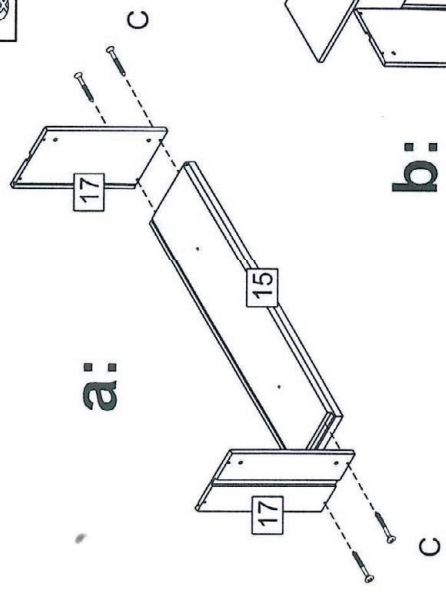

a:

b:

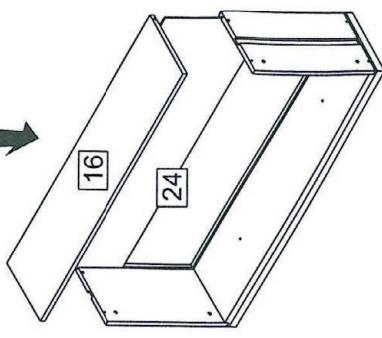

c:

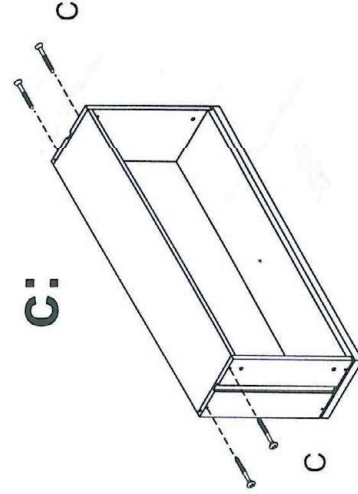

d:

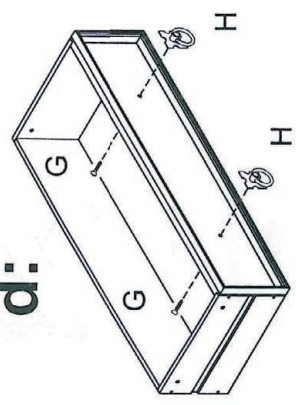

17

Ax4  
Ø6x30mm

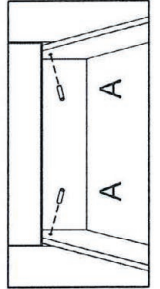
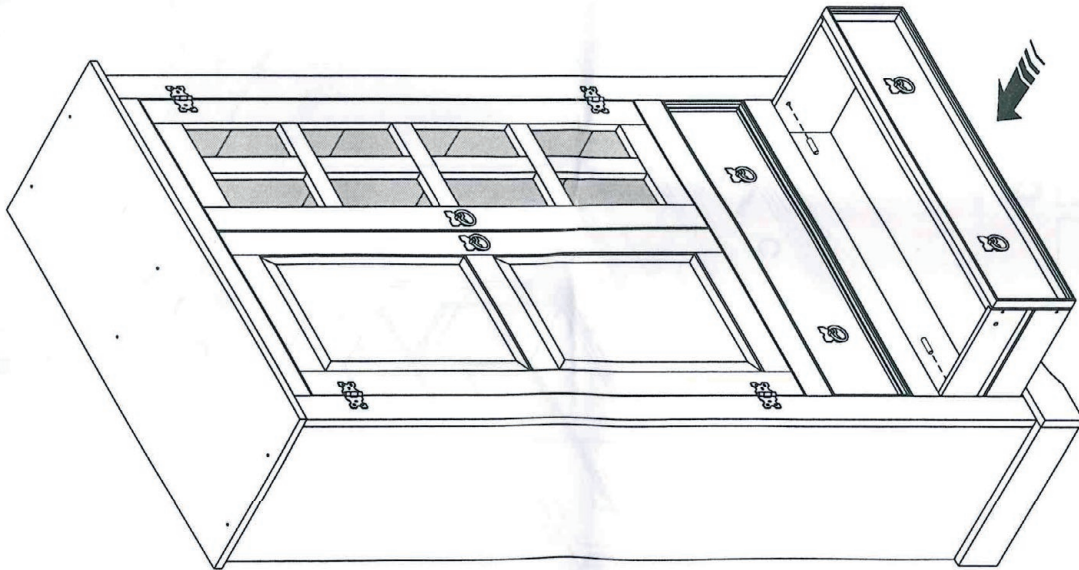

18

Mx46

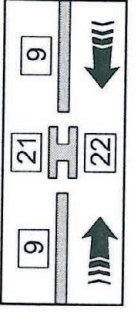
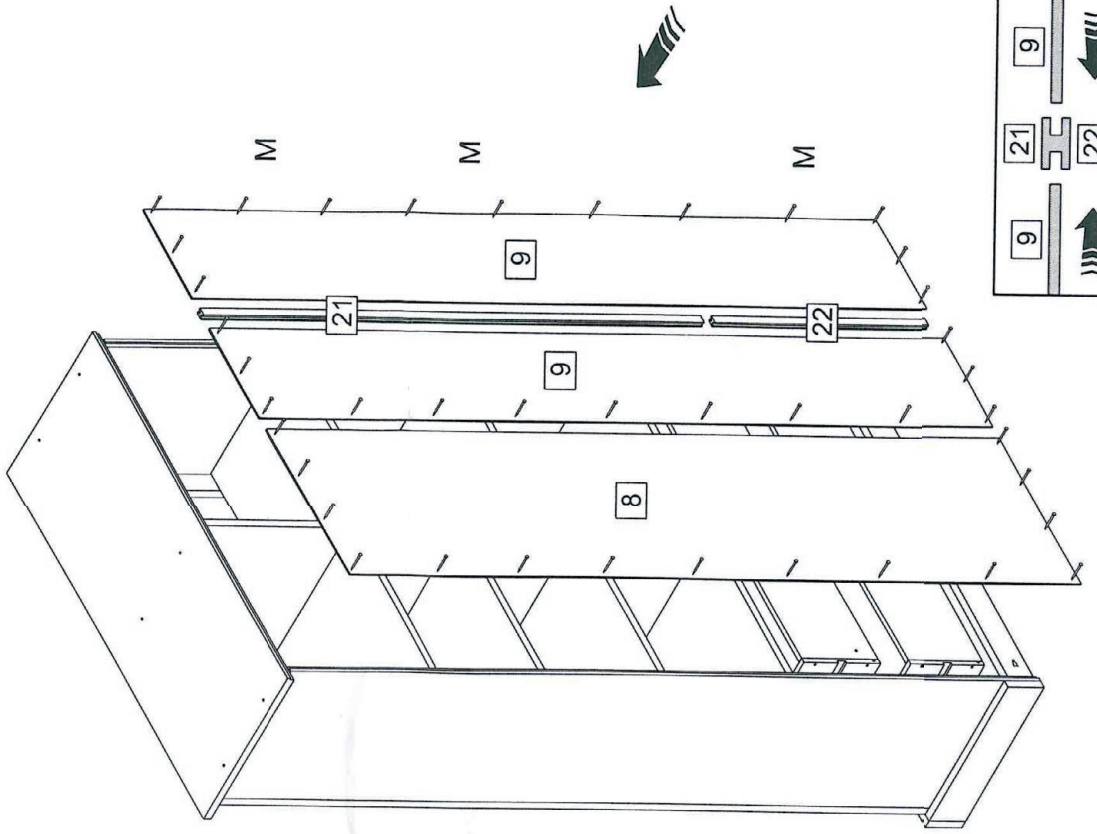
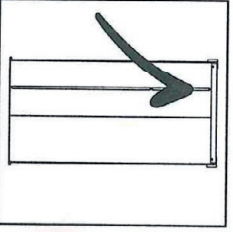
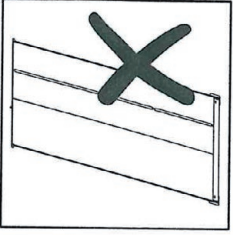
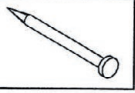

D

Sicherheitshinweise

GB

Safety information

NL

Veiligheidsvoorschriften

PL

Wskazówki dotyczące bezpieczeństwa

TR

Güvenlik bilgileri

RU

Правила техники безопасности

1	D	Ziehen Sie alle Schrauben sowie tragende Verbindungsteile nach ca. 5 Wochen nach, um eine dauerhafte Standsicherheit zu gewährleisten.
	GB	After approx. 5 weeks, tighten all screws and load-bearing connecting parts to ensure permanent stability.
	NL	Draai alle schroeven en ook dragende verbindingstukken na ca. 5 weken nog eens vast, zodat een continue stabiliteit wordt gegarandeerd.
	PL	Aby zagwarantować trwałą stabilność mocowania należy po ok. 5 tygodniach dokręcić wszystkie śruby oraz elementy łączeniowe.
	TR	Tüm vida ve taşıyıcı bağlantı parçalarını kalıcı bir duruş güvenliğini sağlamak için yaklaşık 5 hafta sonra tekrar sıkınız.
	RU	Подкрутите все болты, а также несущие соединительные детали прикл. через 5 недель для обеспечения устойчивости в течение длительного времени.
2	D	Bitte nur mit einem Staubtuch oder leicht feuchtem Lappen reinigen. Keine scheuernden Putzmittel verwenden.
	GB	Please only clean with a duster or a damp cloth. Do not use any abrasive cleaners.
	NL	Reinig alleen met een stofdoek of een lichtjes vochtige doek. Gebruik geen schurende poetsmiddelen.
	PL	Czyszczenie należy wykonać wyłącznie za pomocą ściereczki lub lekko nawilżonego ręcznika. Nie stosować środków czyszczących do szorowania.
	TR	Lütfen sadece bir toz beziyile veya hafif nemli yumuşak bir bezle siliniz. Aşındırıcı temizlik malzemeleri kullanmayınız.
	RU	Очищайте от пыли тряпкой или слегка влажной ветошью. Не допускается применение чистящих средств, не предназначенных для ухода за мебелью.
3	D	Halten Sie den Artikel von Wärmequellen fern.
	GB	Keep the product away from heat sources.
	NL	Houd het artikel uit de buurt van warmtebronnen.
	PL	Produkt należy przechowywać w znacznej odległości od źródeł ciepła.
	TR	Ürünü her türlü ısı kaynağından uzak tutunuz.
	RU	Не устанавливайте изделие вблизи источников тепла.
4	D	Schützen Sie Ihre Möbel generell vor Wasser (z.B. beim Wischen oder Blumen gießen). Die Feuchtigkeit kann in das Möbelstück eindringen und es beschädigen
	GB	In general, keep water away from your furniture (e. g. when mopping or watering plants). The moisture may penetrate the furniture and damage it.
	NL	Bescherm uw meubelen doorgaans tegen water (bijv. bij het dweilen of als u de bloemen water geeft). De vochtigheid kan in het meubelstuk dringen en het beschadigen.
	PL	Mebel należy chronić przed wodą (np. podczas czyszczenia lub podlewania kwiatków). Wilgoć może wnikać w mebel i uszkodzić go.
	TR	Genelde mobilyalarınızı sudan koruyunuz (örneğin, yerleri paspaslarken veya çiçekleri sularken). Nem, mobilya parçasına nüfuz edebilir ve zarar verebilir.
	RU	Предохраняйте мебель от попадания воды (например, при вытирании или поливке цветов). Не допускайте попадания влаги на мебель, чтобы предотвратить ее повреждение.
5	D	Achten Sie darauf, dass Kinder keine kleinen Teile, wie z. B. Muttern, Abdeckkappen oder Ähnliches in den Mund nehmen. Sie könnten sie verschlucken und daran ersticken.
	GB	Ensure that children do not put any small parts such as nuts, caps or the like in their mouth. They could swallow and choke on them.
	NL	Zorg ervoor dat kinderen geen kleine stukken, zoals moeren, afdekkapjes of dergelijke in de mond nemen. Ze kunnen ze inslikken en daardoor stikken.
	PL	Należy dopilnować, aby dzieci nie oderwały od mebla żadnych drobnych części, takich jak np. nakrętki, pokrywki itp. oraz nie włożyły ich do ust. Mogłyby je połknąć i udusić się nimi.
	TR	Çocukların somun, muhafaza kapakçıkları ve benzeri küçük parçaları ağızlarına almamalarına dikkat ediniz. Bunları yutabilirler ve boğulabilirler.
	RU	Следите, чтобы мелкие детали, например гайки, крышки и т. п., не попали в рот ребенка. Дети могут их проглотить и задохнуться.
6	D	<b>Beschädigungsgefahr!</b> Gehen Sie bei der Montage des Artikels sorgfältig vor und halten Sie sich an die Montageanleitung. Der Artikel darf nur von fachkundigen Personen montiert werden.
	GB	<b>Risks of damage!</b> When assembling the product, please proceed with caution and comply with the assembly instructions. The product may only be assembled by persons with the necessary knowledge and competence.
	NL	<b>Risico op beschadiging!</b> Ga bij de montage van het artikel zorgvuldig te werk en houd u aan de handleiding voor de montage. Het artikel mag alleen worden gemonteerd door vaklui.
	PL	<b>Niebezpieczeństwo uszkodzenia!</b> Regał należy złożyć zgodnie z instrukcją montażu. Artykuł powinien zostać złożony przez fachowca.
	TR	<b>Hasar oluşması tehlikesi!</b> Montaj esnasında büyük bir itinayla çalışınız, ürünle dikkatlice çalışınız ve mutlaka montaj talimatına uyunuz. Ürün sadece bu konuda uzman bir kişi tarafından monte edilmelidir.
	RU	<b>Опасность повреждения!</b> При монтаже изделия будьте внимательны и соблюдайте инструкции по монтажу. Изделие разрешается устанавливать только квалифицированному персоналу.