

2018-11-20

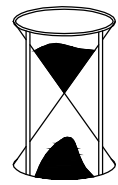

30min.

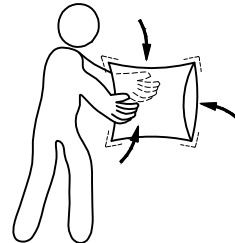
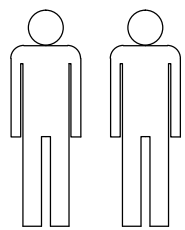
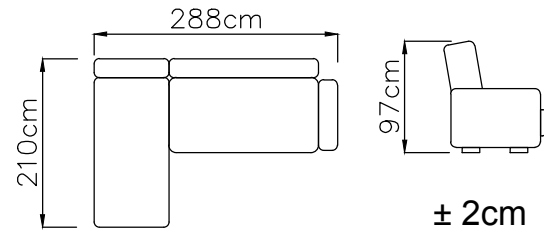

Belavio-SET2

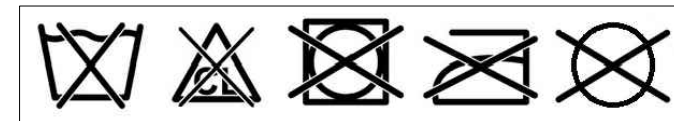
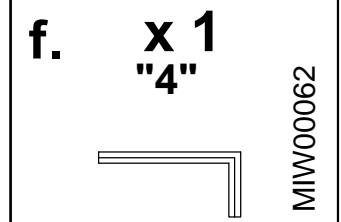
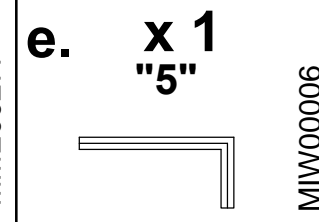
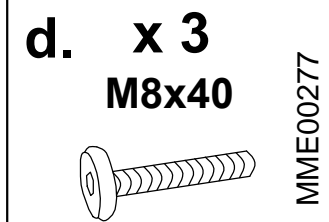
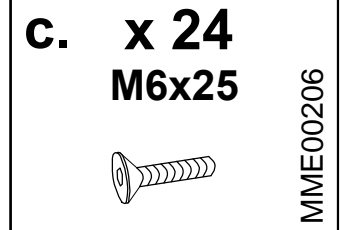
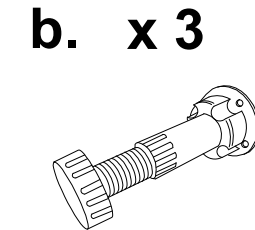
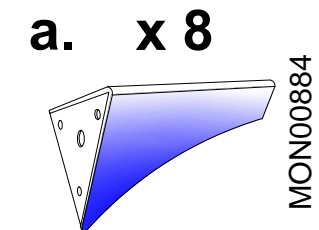
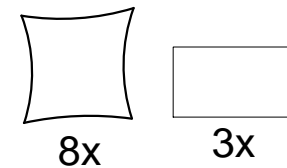
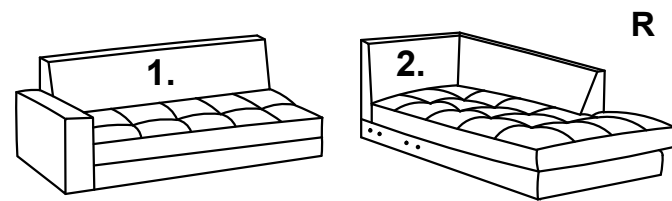
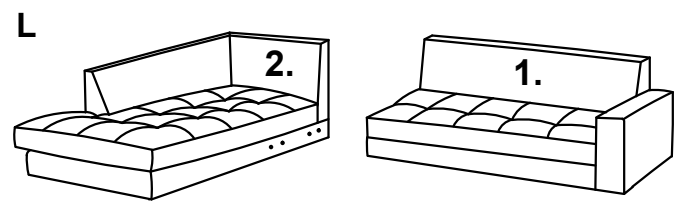
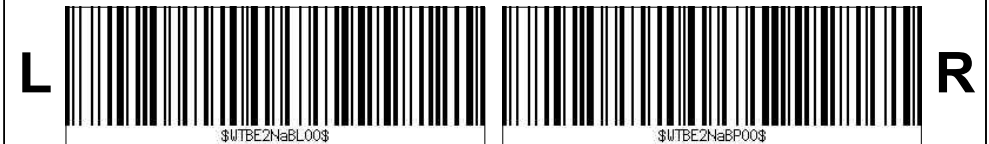

I

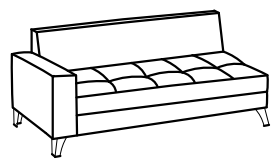

| | | | |
|---------|-------|--------|-------|
| a. x 4 | | b. x 1 | |
| c. x 12 | M6x25 | d. x 1 | M8x40 |
| f. x 1 | "4" | e. x 1 | "5" |

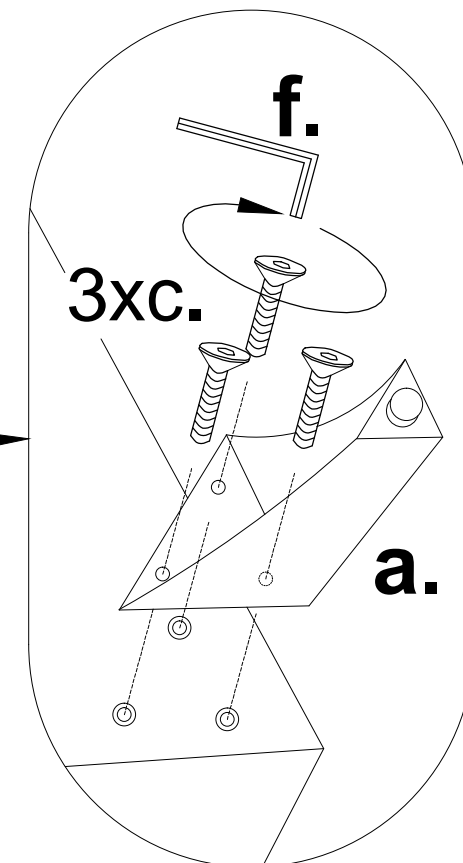
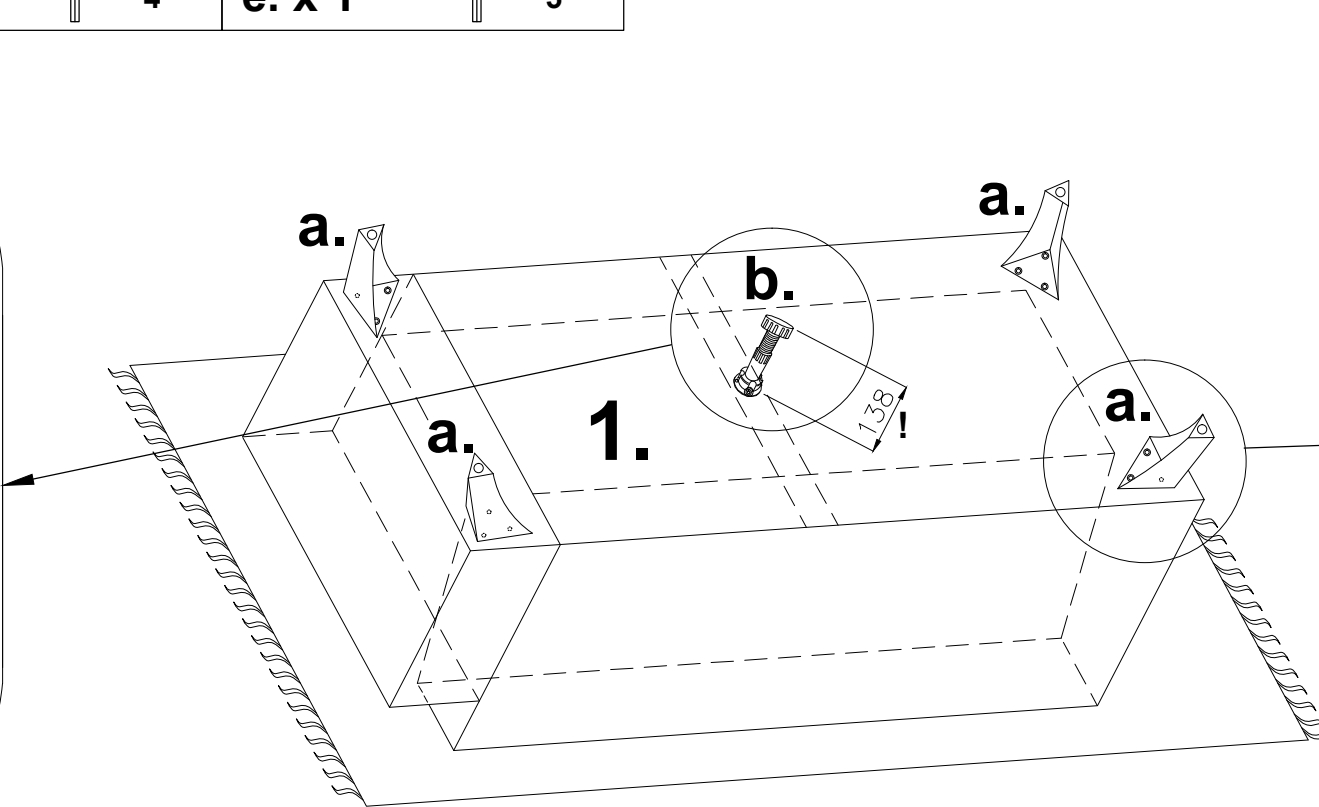
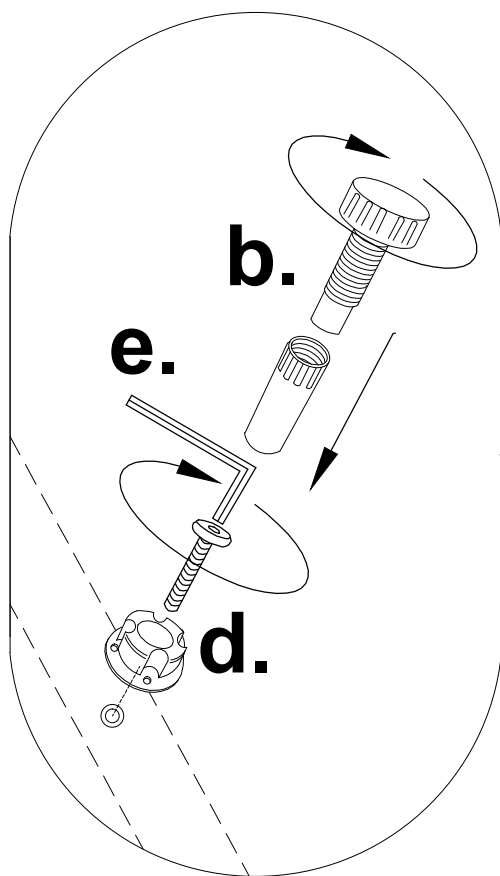

2018-11-20

Belavio-SET2

II



| | | | |
|---------|--|--------|--|
| a. x 4 | | b. x 2 | |
| c. x 12 | | d. x 2 | |
| f. x 1 | | e. x 1 | |

