

# PROFI PFR03

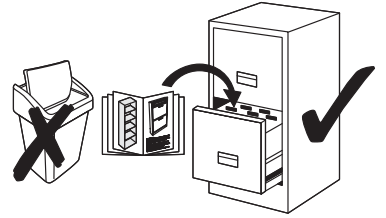
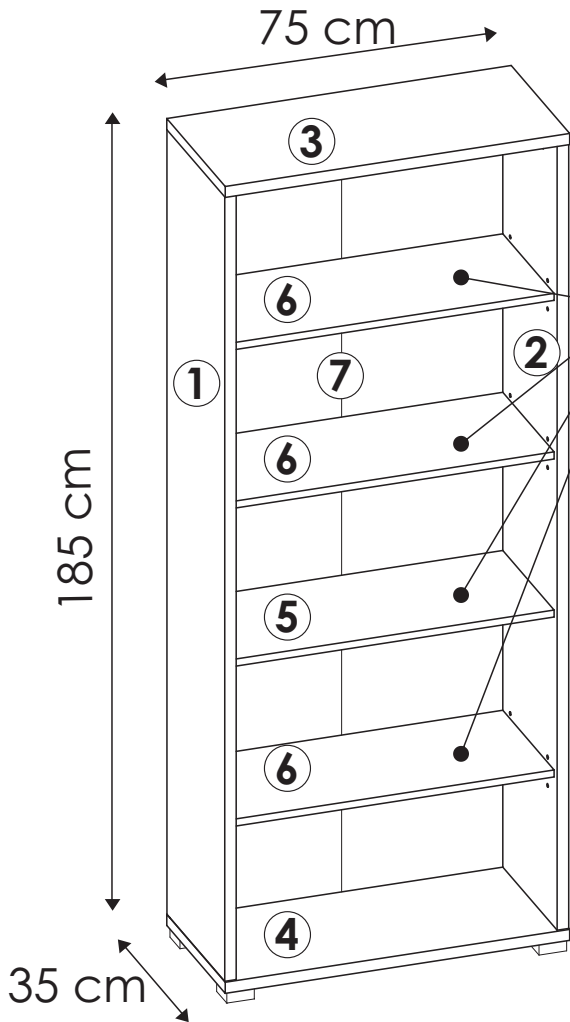

max. 5 kg

|                                 |                         |                                |                                 |                      |
|---------------------------------|-------------------------|--------------------------------|---------------------------------|----------------------|
| <b>a1</b><br>8x35<br>x....(x12) | <b>d6</b><br>x....(x12) | <b>e0</b><br>x....(x8)         | <b>e1</b><br>x....(x8)          | <b>f1</b><br>x..(x8) |
| <b>g2</b><br>7x60<br>x....(x4)  | <b>g0</b><br>x....(x4)  | <b>i2</b><br>4x16<br>x....(x1) | <b>i11</b><br>4x30<br>x....(x8) |                      |
| <b>m</b><br>x....(x1)           | <b>o13</b><br>x....(x4) | <b>q9</b><br>x....(x1)         |                                 |                      |
| <b>r4</b><br>x....(x10)         | <b>z</b><br>x....(x1)   |                                |                                 |                      |

- ① - C2
- ② - C2
- ③ - C1
- ④ - C1
- ⑤ - C1
- ⑥ - C1
- ⑦ - C2

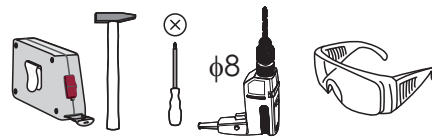
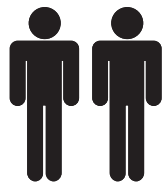
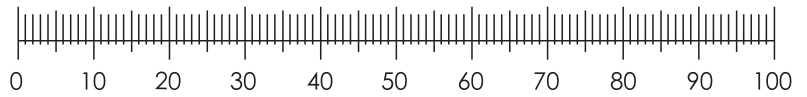
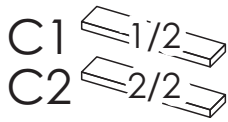

1

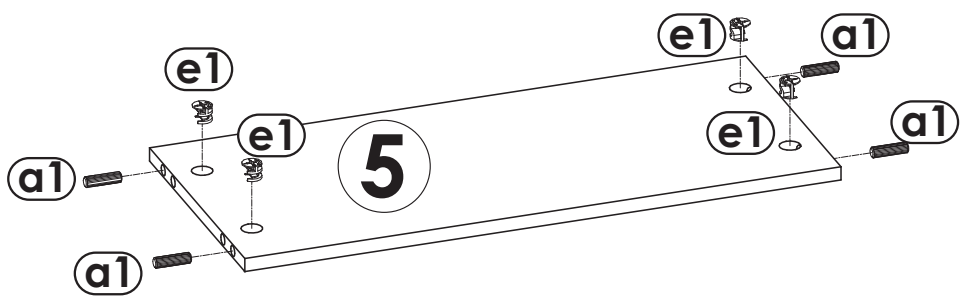
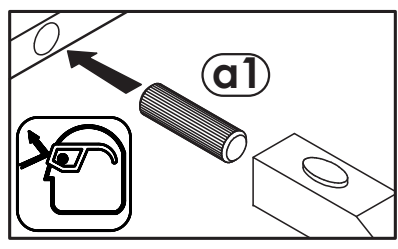
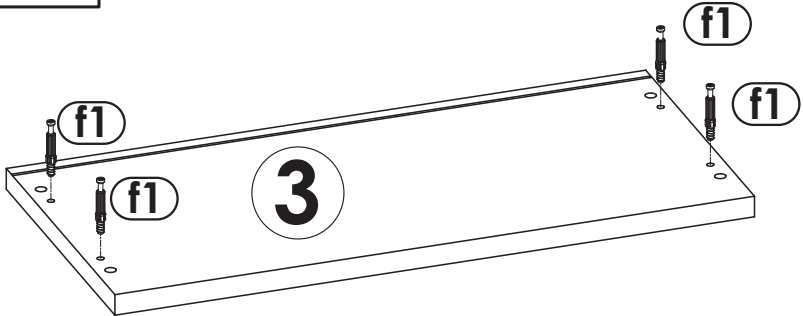
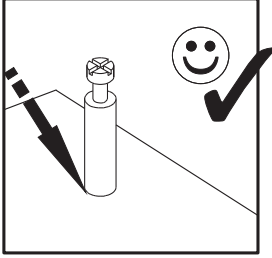
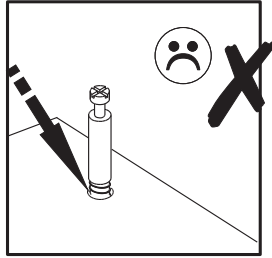
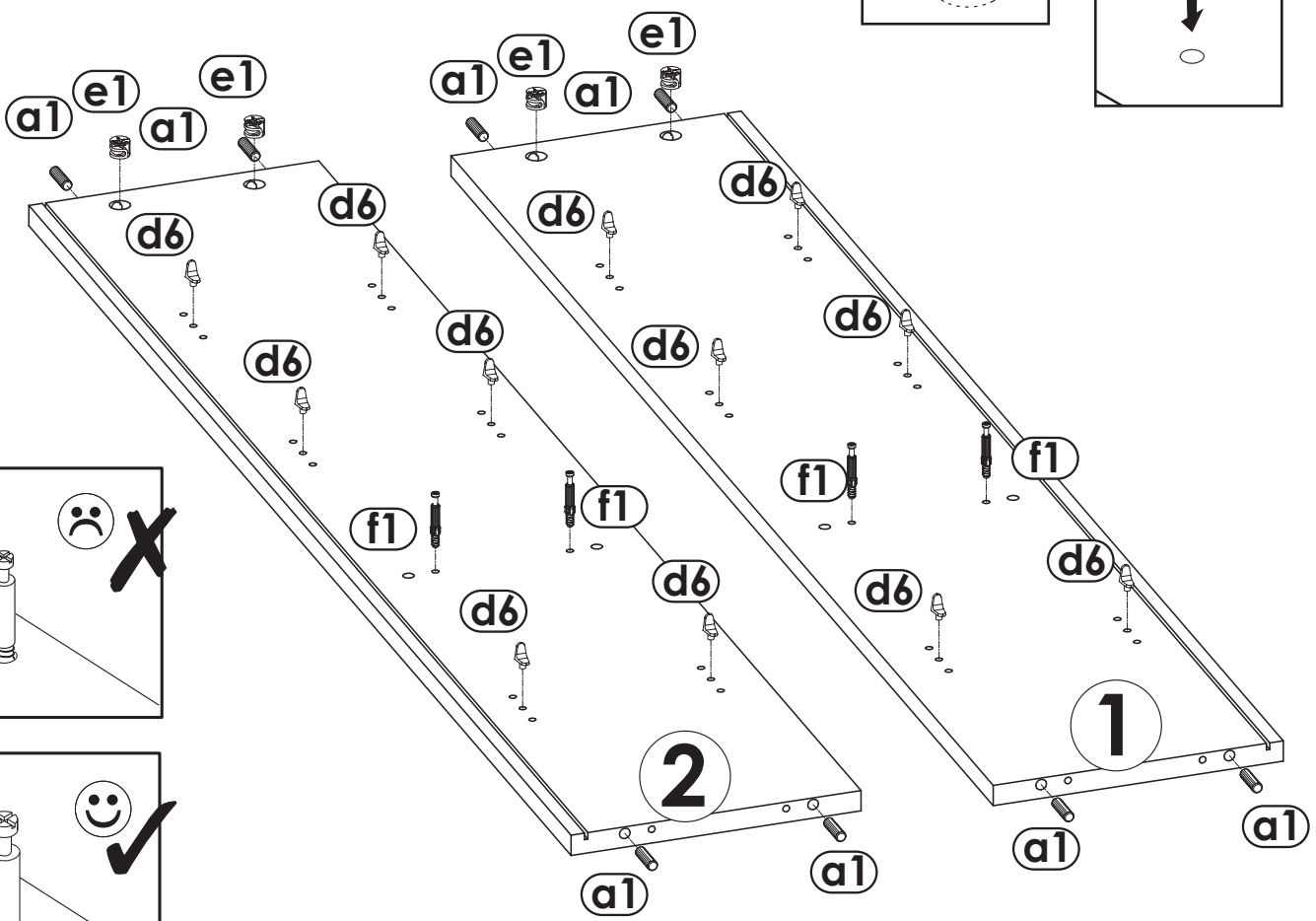
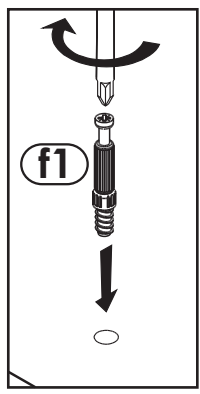
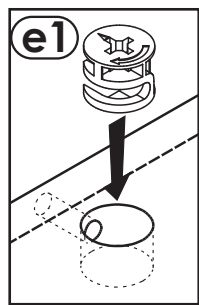
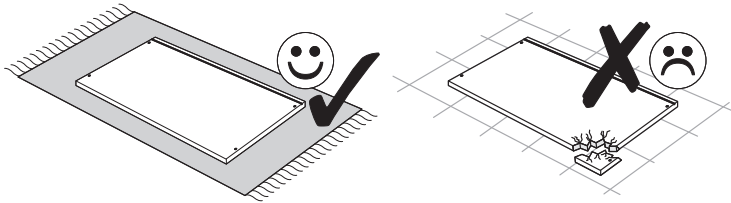

# 2

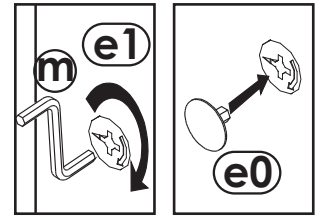
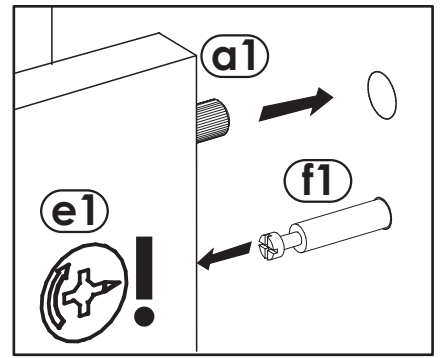
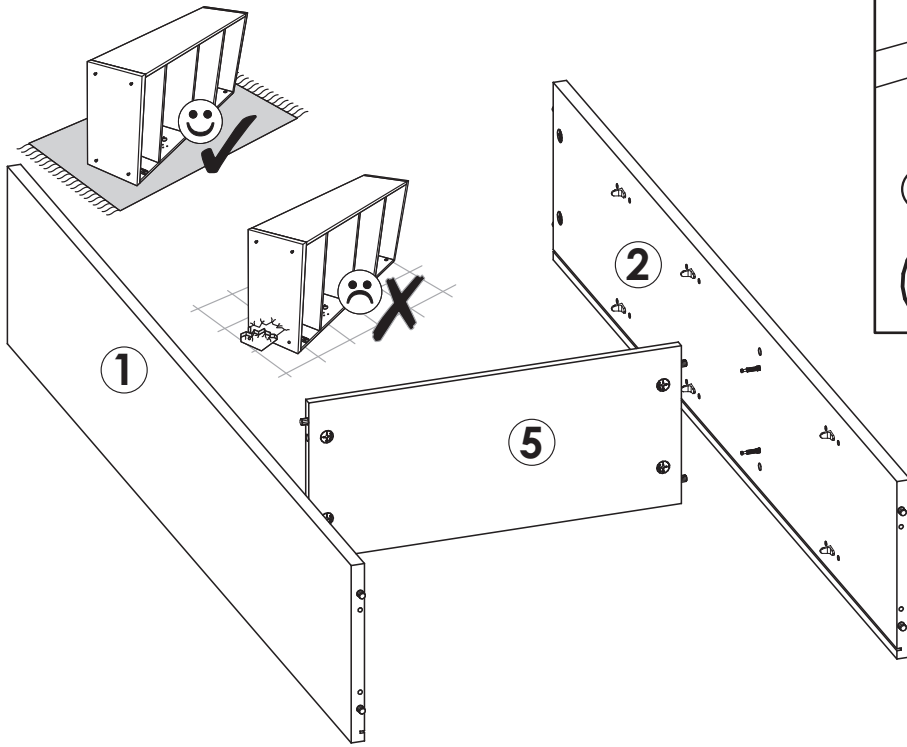

# 3

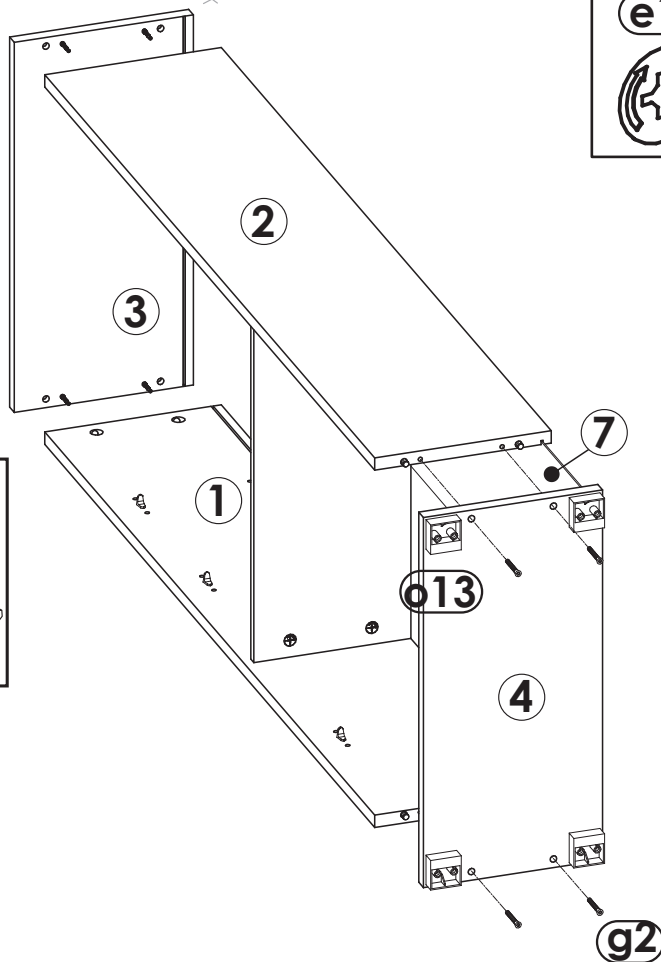
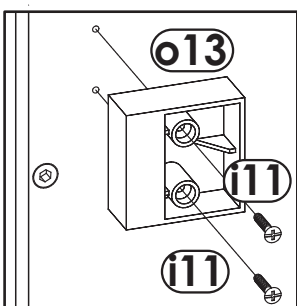
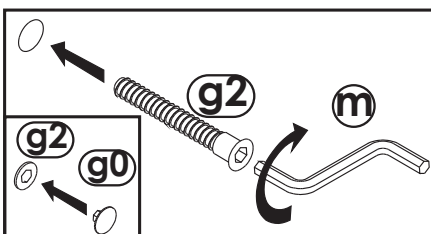
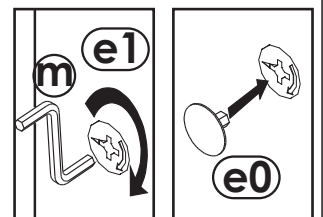
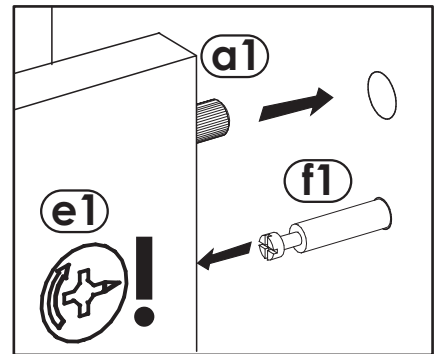
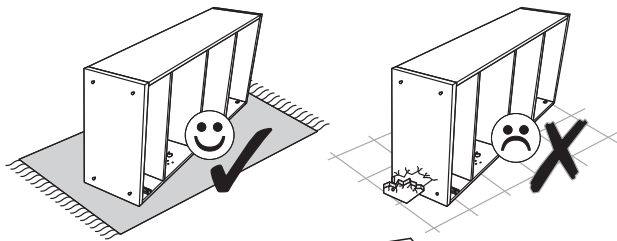

4  
▼

A=B

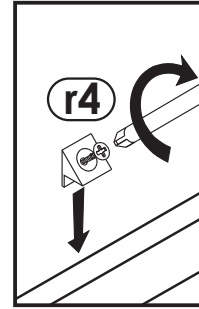
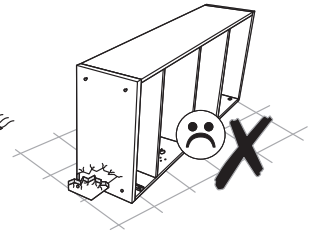
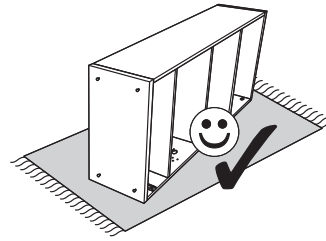
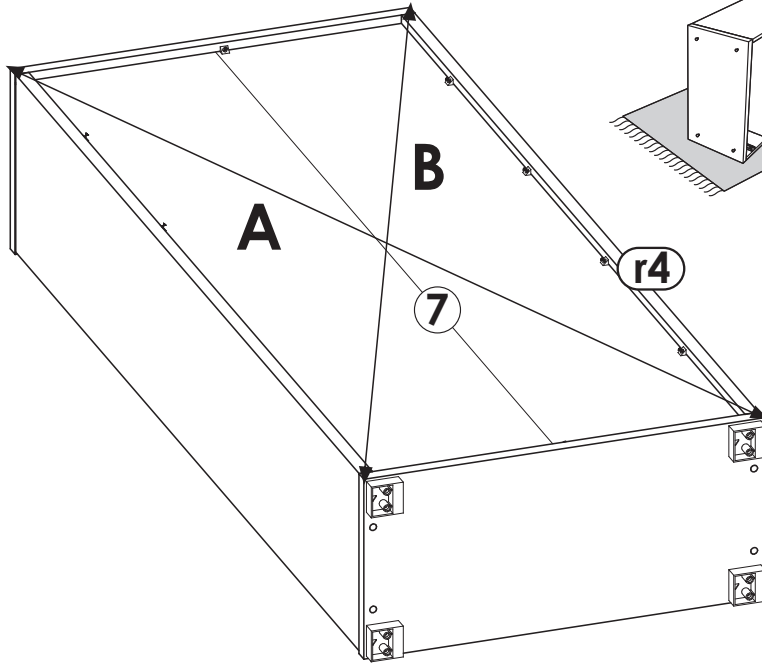

5  
▼

