

# K49-G1D/45/80

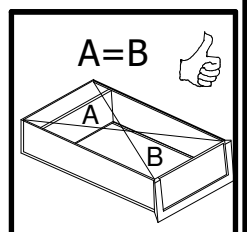
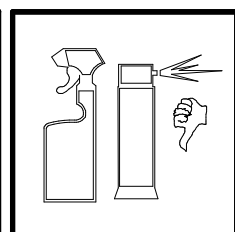
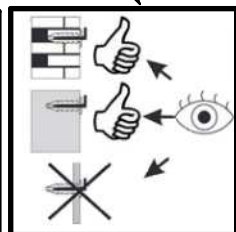
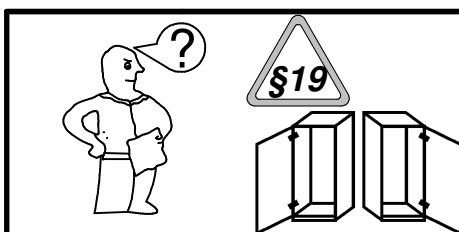
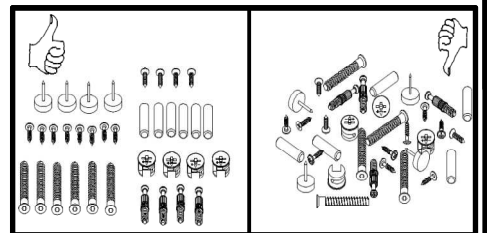
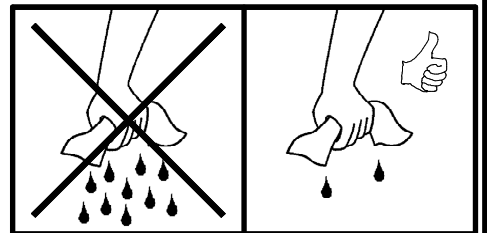
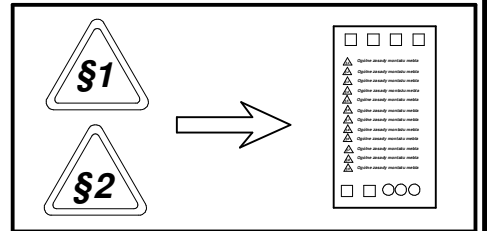
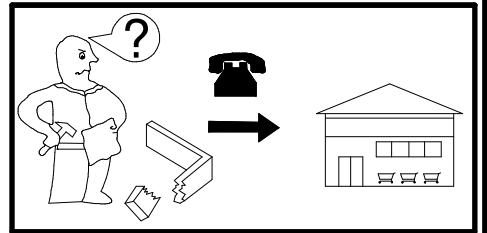
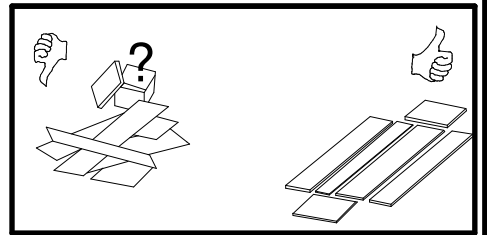
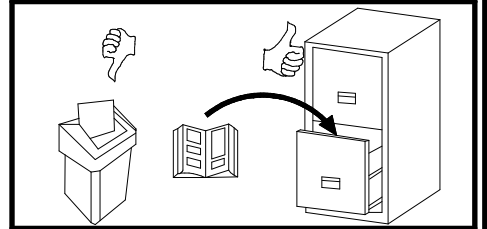
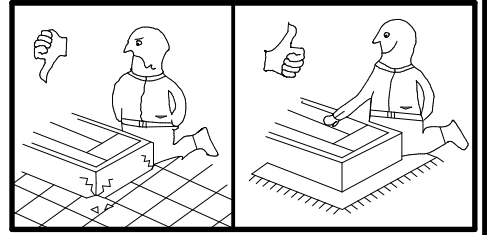
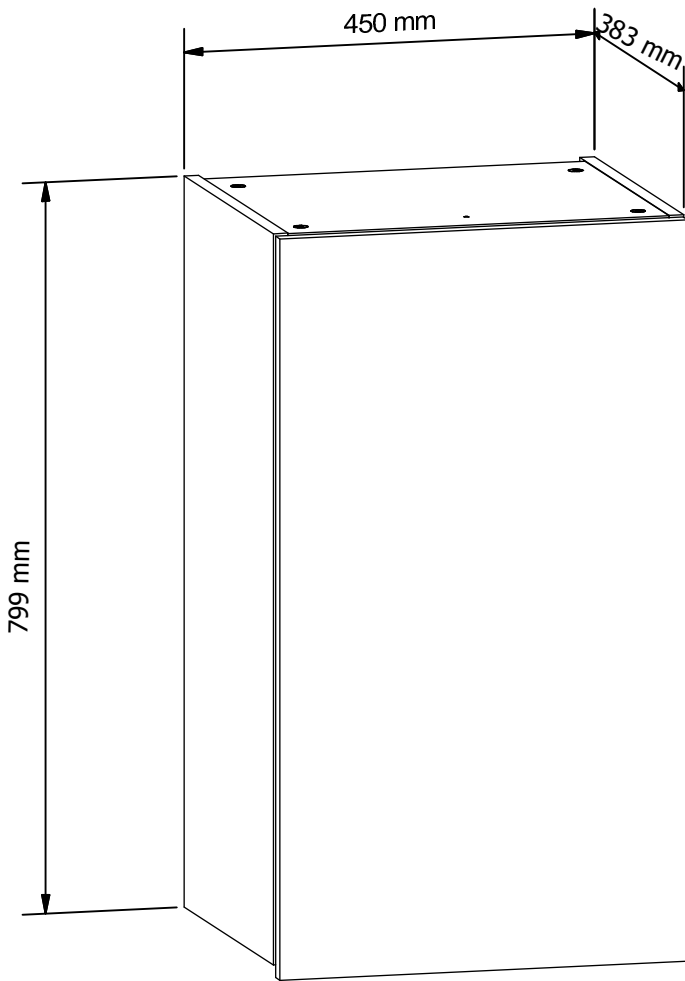
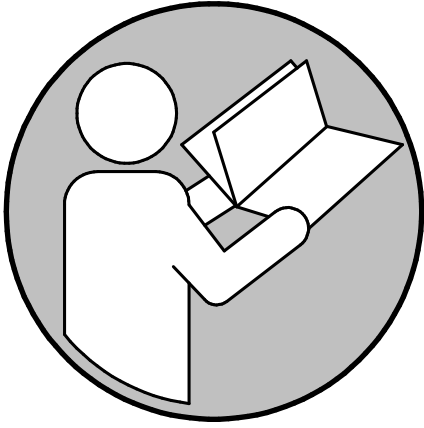

**A**

**K49-G1D/45/80**

A	B	C	D	
1	K49-0001	797	447	2/2
2	K49-1001	786	365	1/2
3	K49-1002	786	365	1/2
4	K49-3001	418	345	1/2
5	K49-3002	417	329	1/2
6	K49-3011	418	345	1/2
7	K49-9001	781	428	1/2

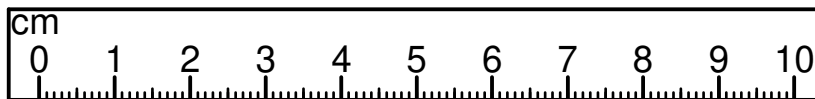
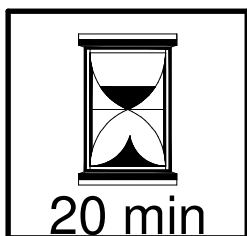
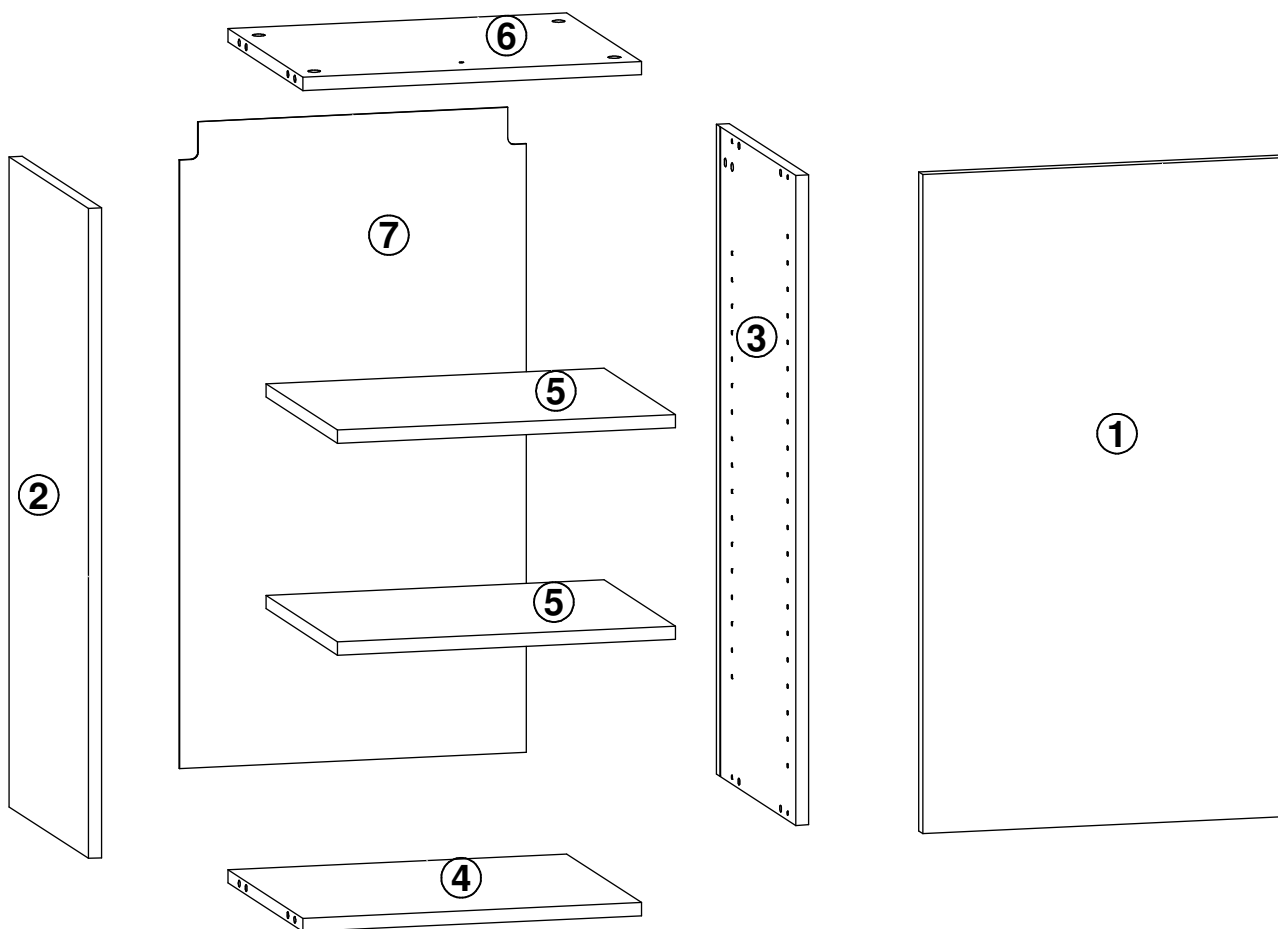
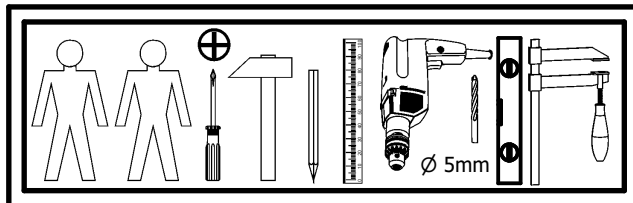

2x hamulec a204 Ø35	2x b2 b90	8x d1 Ø5x17 mm	8x f1 Ø8x30 mm	4x j45/1 M4x12 mm	2x j45/2 Ø5x23 mm	8x I96 2,5x22mm	1x n165/P	1x n165/L
4x p21 Ø4x30 mm	4x p51 Ø3,5x15 mm	8x r1 Ø15x12 mm #16	8x r42 Ø12,7x3,5 mm	2x silikon s50 Ø12,7x3,5 mm	4x s68 Ø 20mm	1x qc35/LP		

# 1

8x  d1  
∅5x17 mm

1x  n165L

1x  n165P

4x  p21  
∅4x30 mm

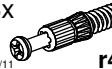
8x  r42  
20/11

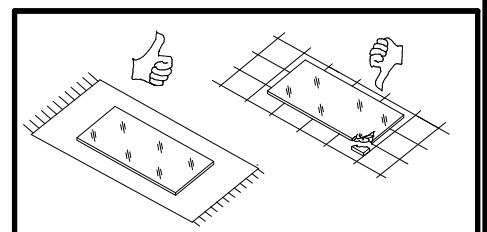
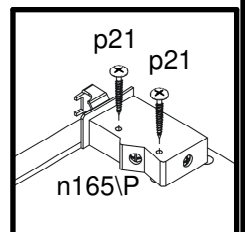
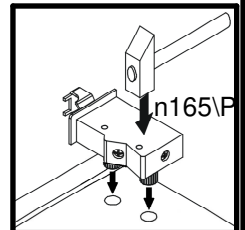
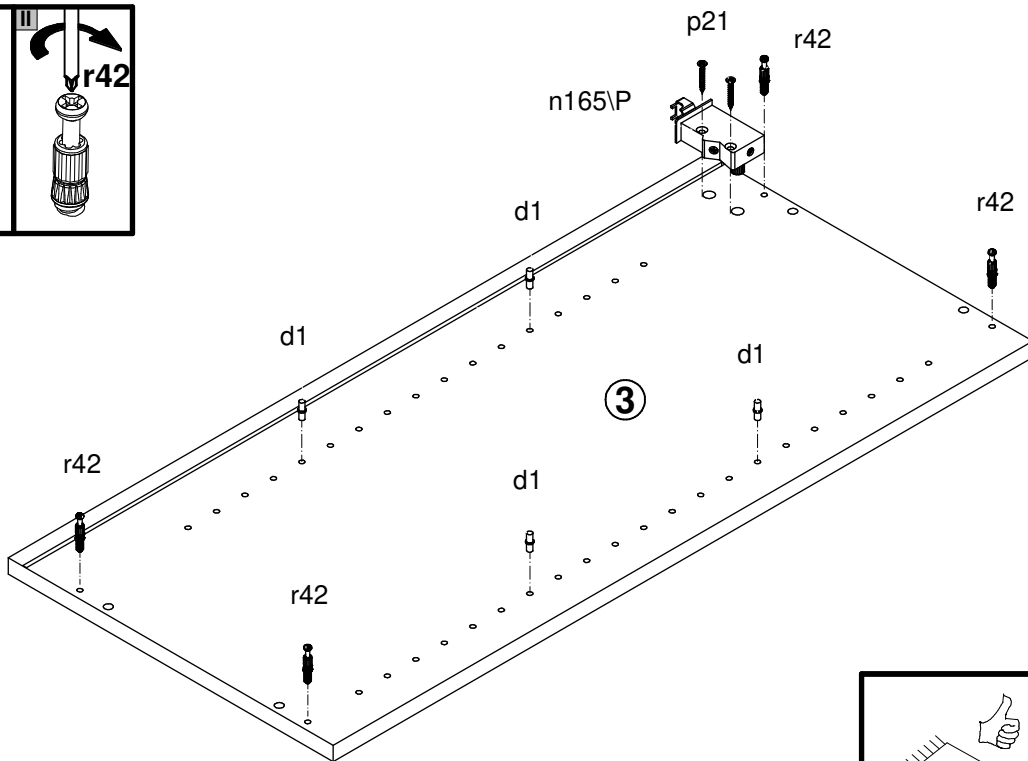
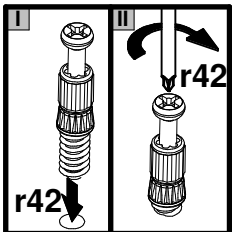
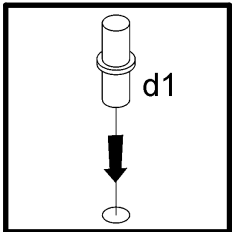
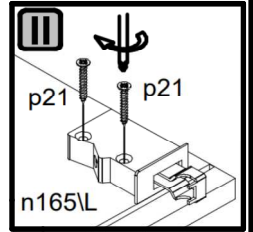
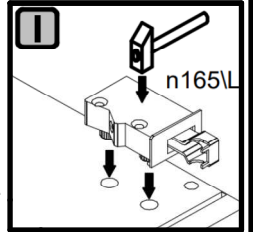
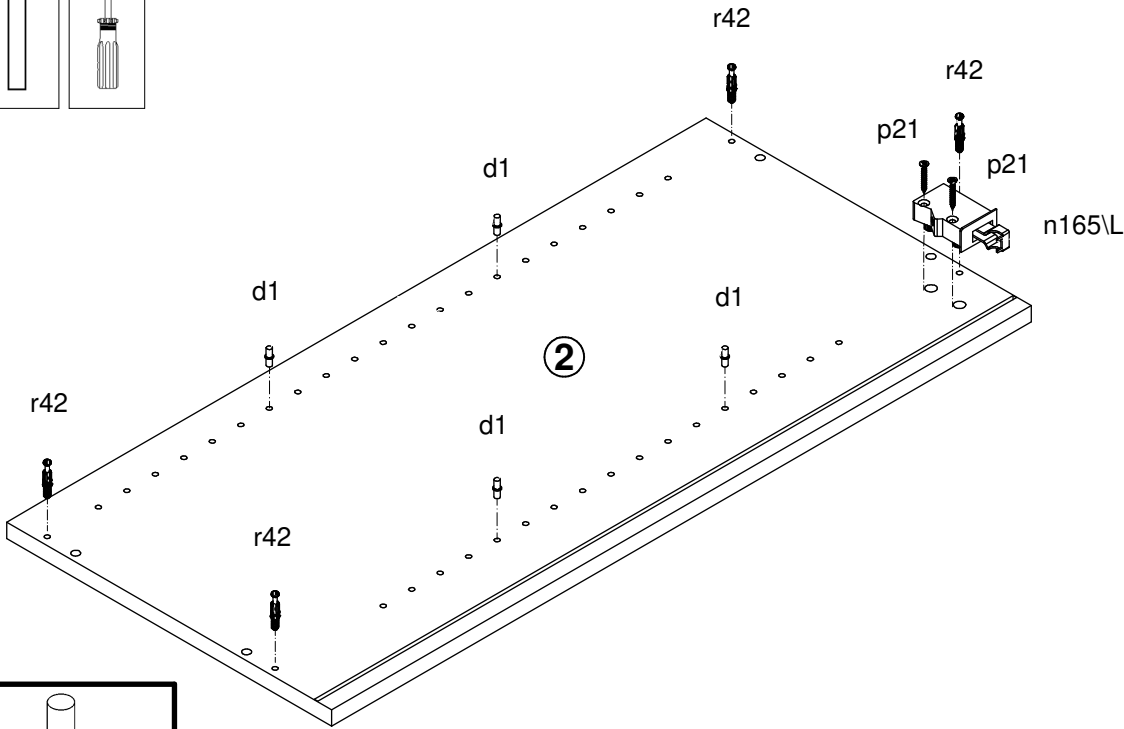
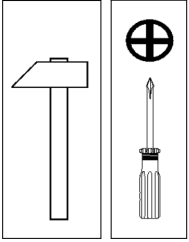

# 2

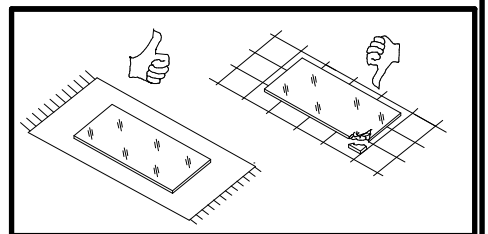
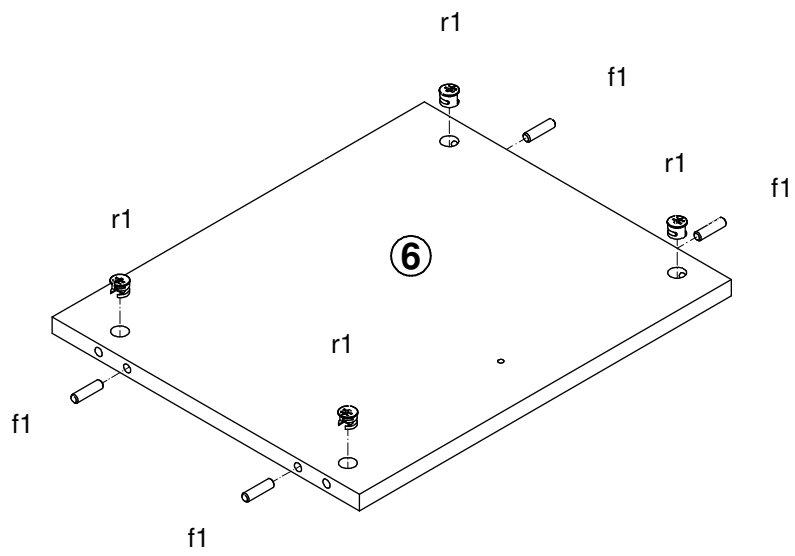
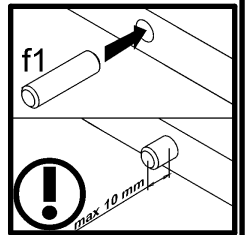
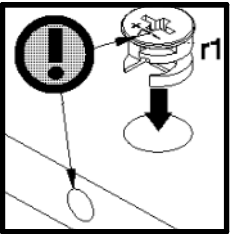
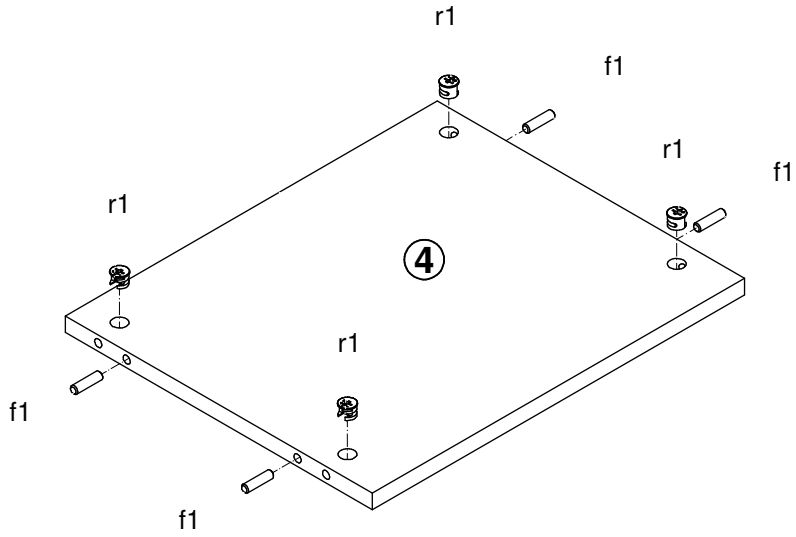
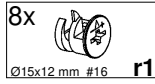
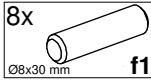

# 3

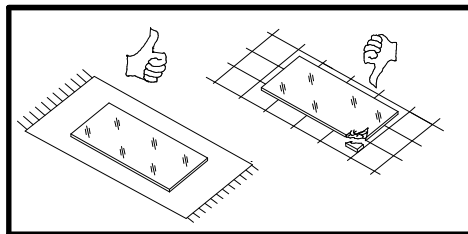
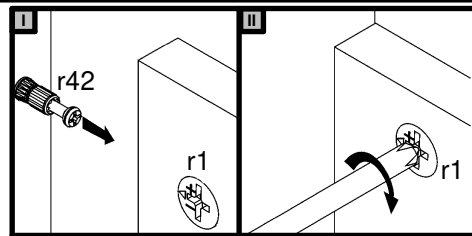
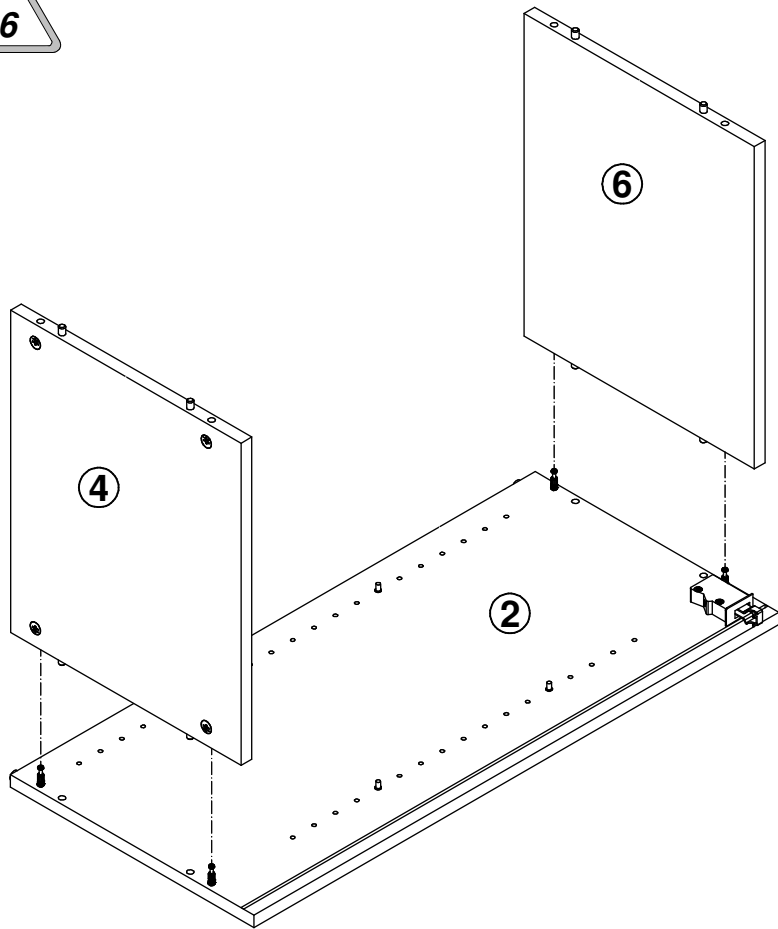

# 4

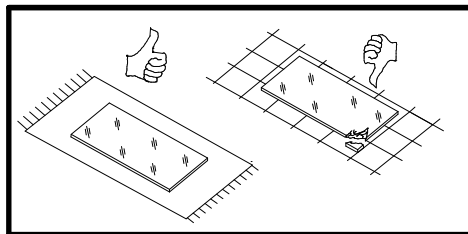
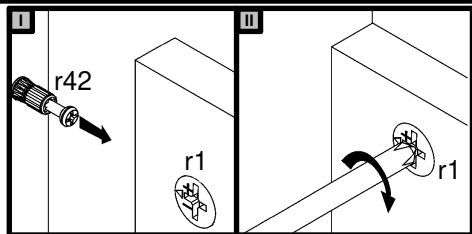
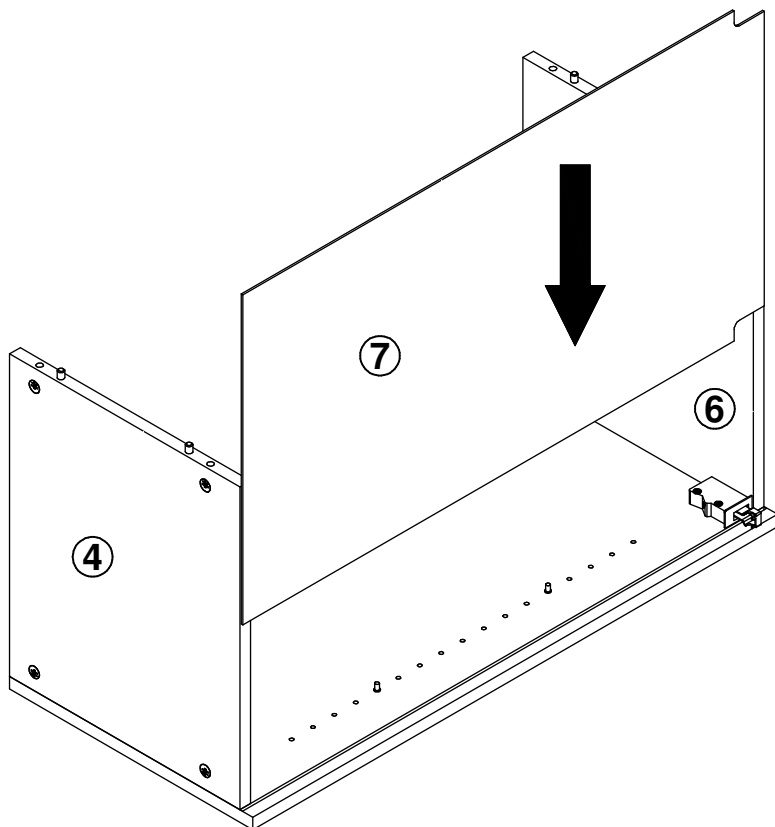

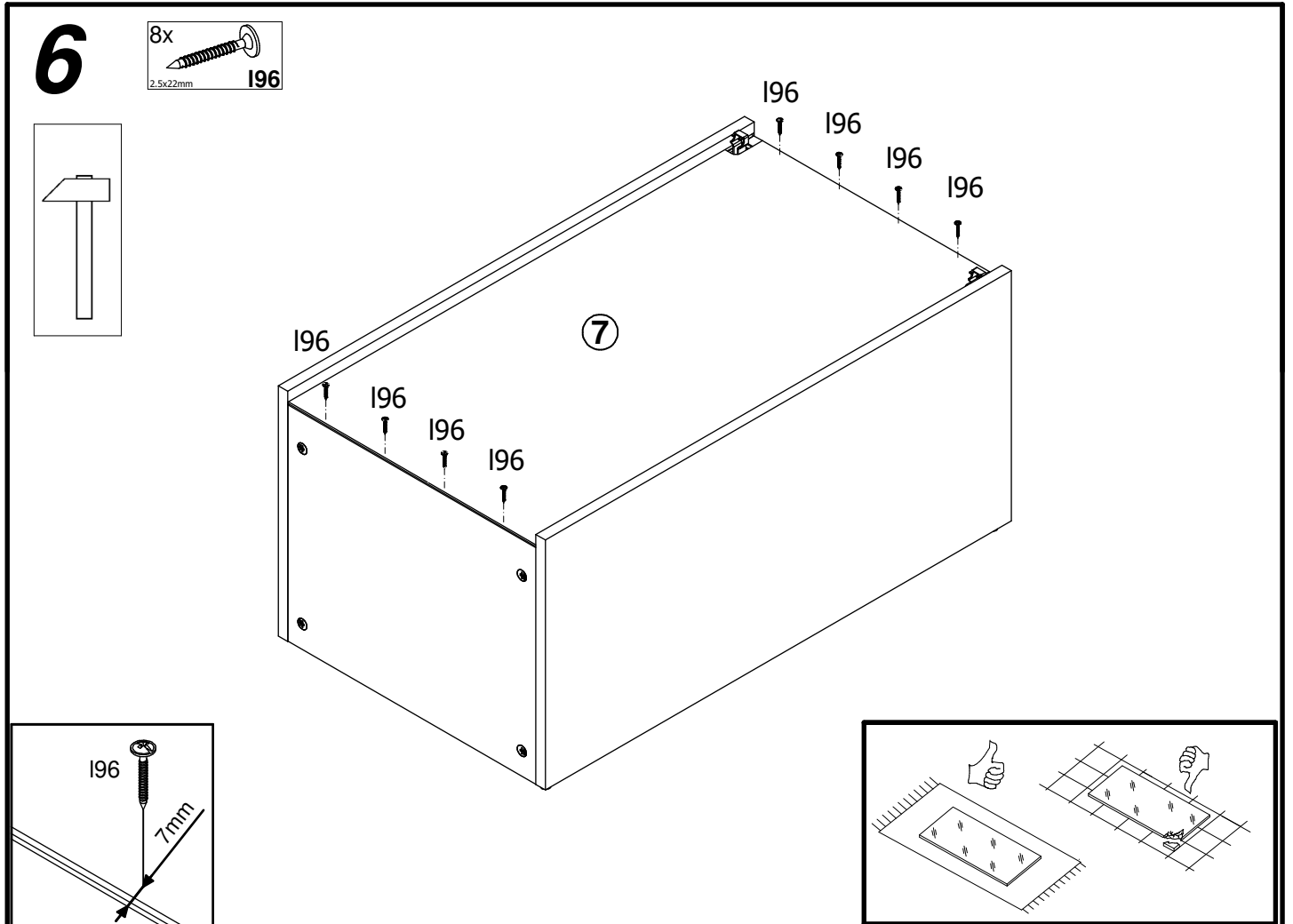
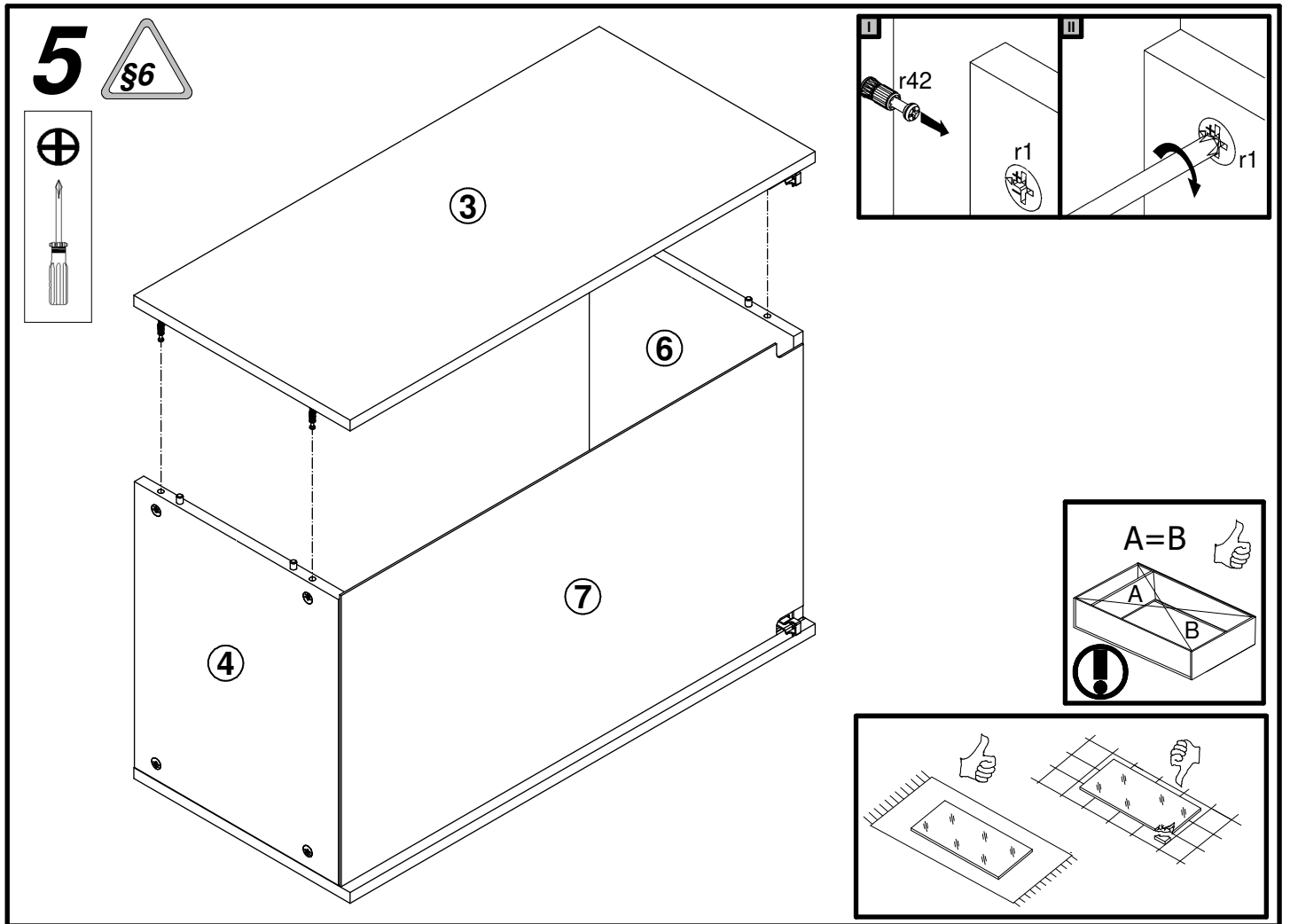



Due to the wide diversity of wall or partition types, we cannot provide you with suitable attachment fixtures. To determine which attachment fixtures to use, you will need to identify the type of wall to which you will be fixing this product. Here are some examples of attachment fixtures recommended for:



**BLIND WALLS**

**"FISCHER"**  
Nylon plug

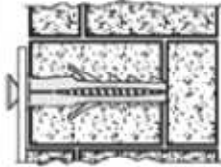

**Metal**  
Wall plug

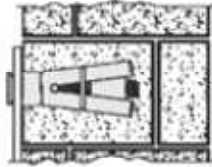
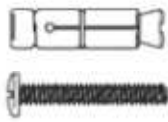

**Nylon winged**  
Wall plug

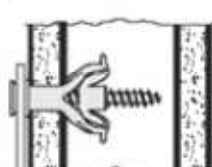

**STUDDED WALLS**

**Metal expansion**  
plug

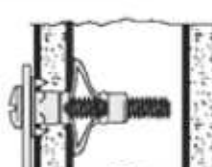

**"MOLLY"** plug

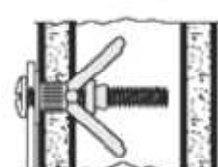
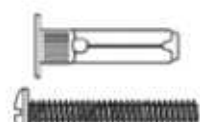

Use a drill bit that is compatible in size with the hardware used and the type of wall.



Da es eine große Vielfalt an Arten von Wänden oder Trennwänden gibt, können wir Ihnen leider keine Wanddübel zur Verfügung stellen. Bitte prüfen Sie die Eigenschaft der Wand, an der Sie das Möbelstück befestigen wollen, um den dafür passenden Wanddübel zu ermitteln. Ziehen sie ggf. eine Fachkraft zurate. Hier einige Beispiele für Wände und dafür passende Dübel:



**Massivwände**

Kunststoffdübel

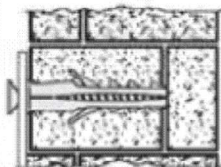
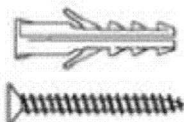

**Metall**  
Wanddübel

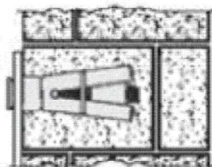
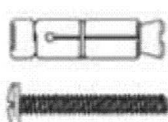

**Hohlraum**  
Kunststoffdübel

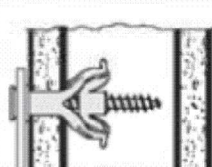
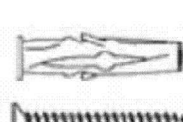

**Hohlwände**

**Hohlraum**  
Metalldübel

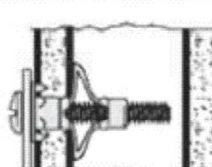
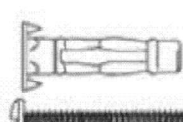

**Hohlraum**  
dübel  
"Molly"

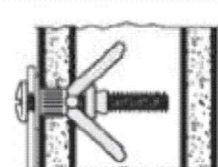
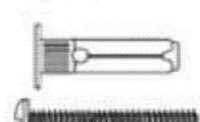

Verwenden Sie einen an die Wandbeschaffenheit und Dübelgröße angepassten Bohrer.



ATTENTION! Fixez le segment au mur. L'opération est à réaliser après le montage complet du meuble. La non-exécution de fixation ou une fixation inadéquate présente un risque de renversement (déchirement) lors du montage et utilisation du meuble. La fixation du meuble au mur ne peut être réalisée que par un personnel compétent. Avant de fixer le meuble au mur, assurez-vous qu'il est bien adapté pour la fixation des meubles, choisissez une cheville appropriée, vérifiez la charge et la qualité de fixation.

NOTE! Attach unit to wall when completely assembled. Improperly attached furniture may break free and fall while being mounted or used. The unit may only be attached to the wall by a qualified person. Check that the wall is suitable for having furniture attached to it beforehand. Choose a suitable anchor bolt and check the strength and quality of the attachment.

# 7

1x  
qc35\LP

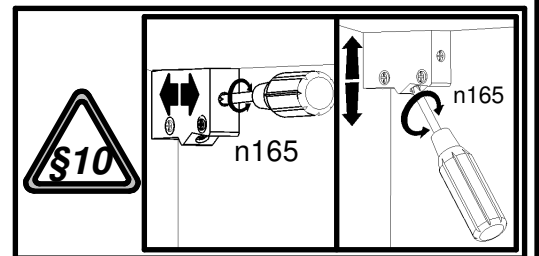
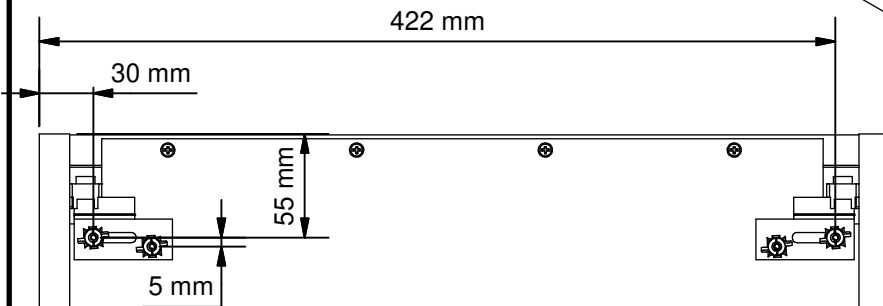
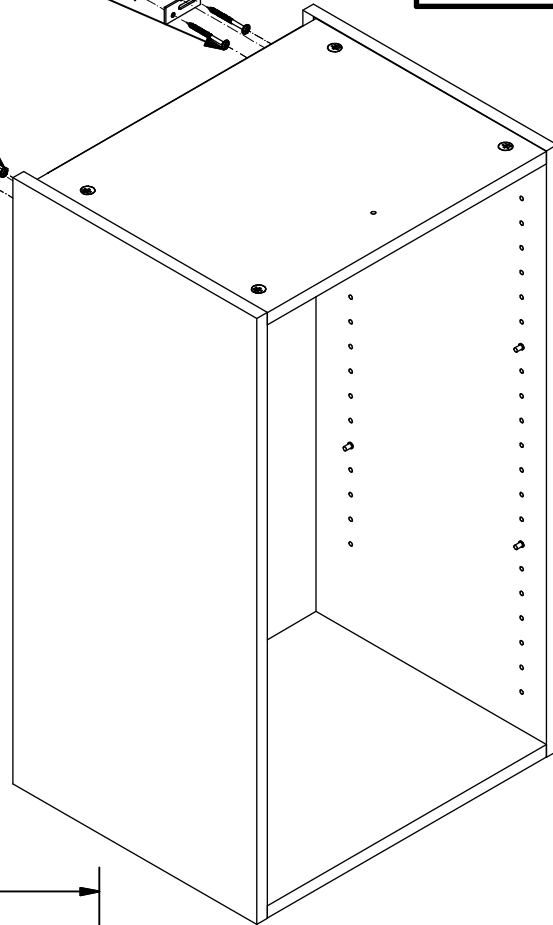
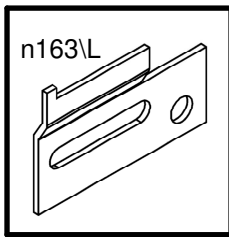
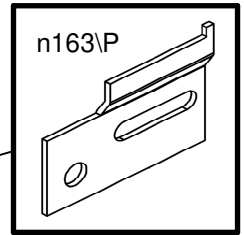
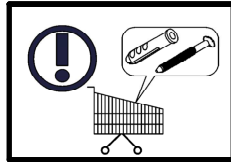
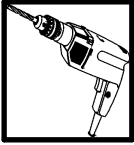
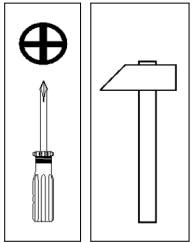
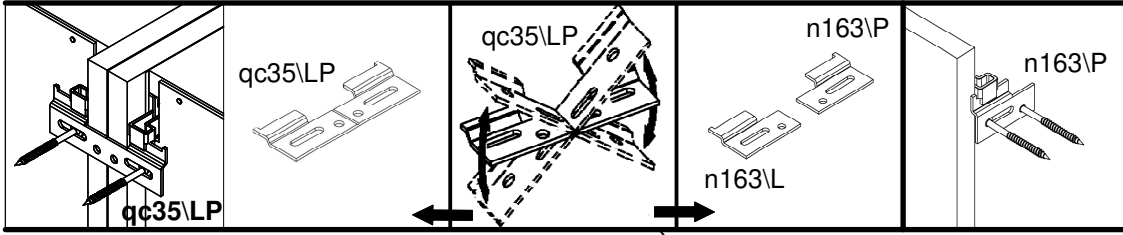



8

4x  
M4x12 mm  
j45\1

2x  
Ø5x23 mm  
j45\2

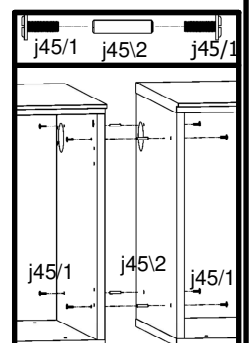
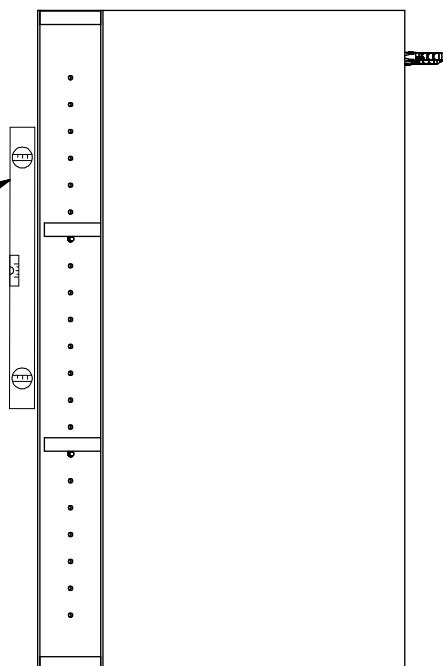
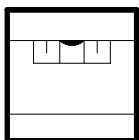
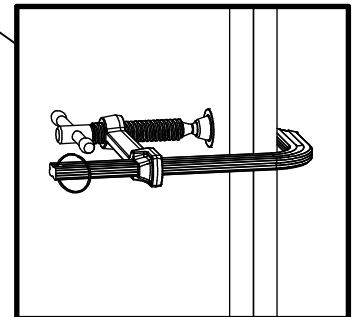
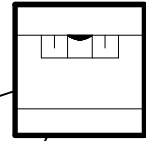
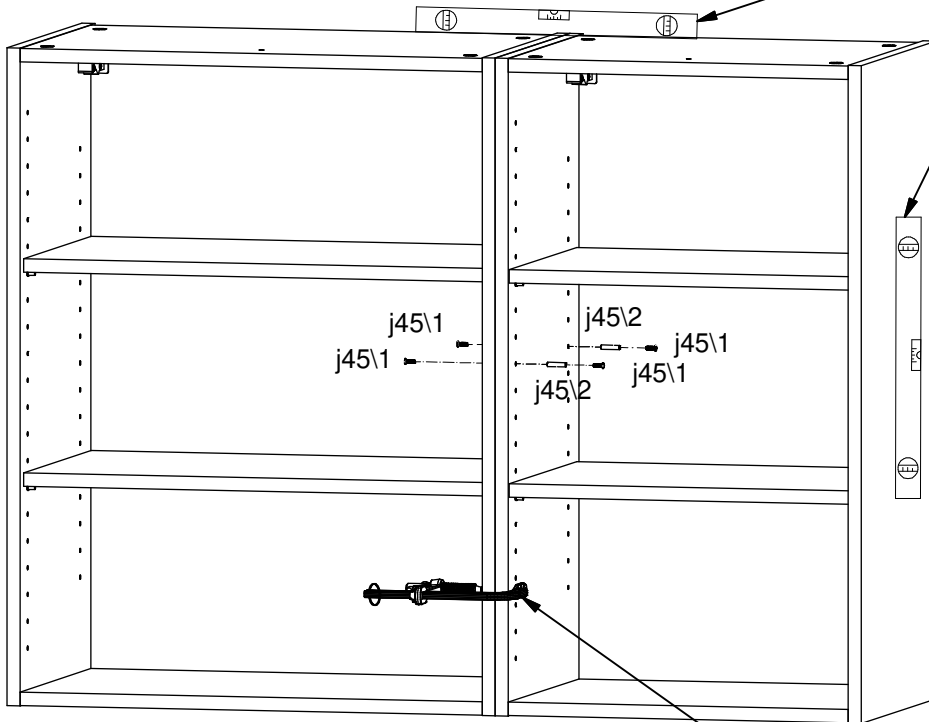
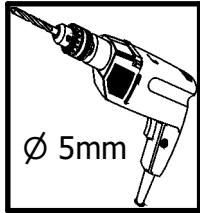

# 9

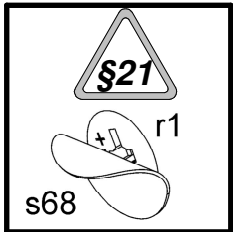
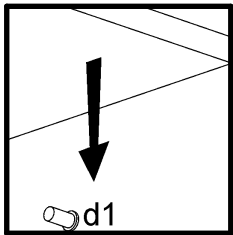
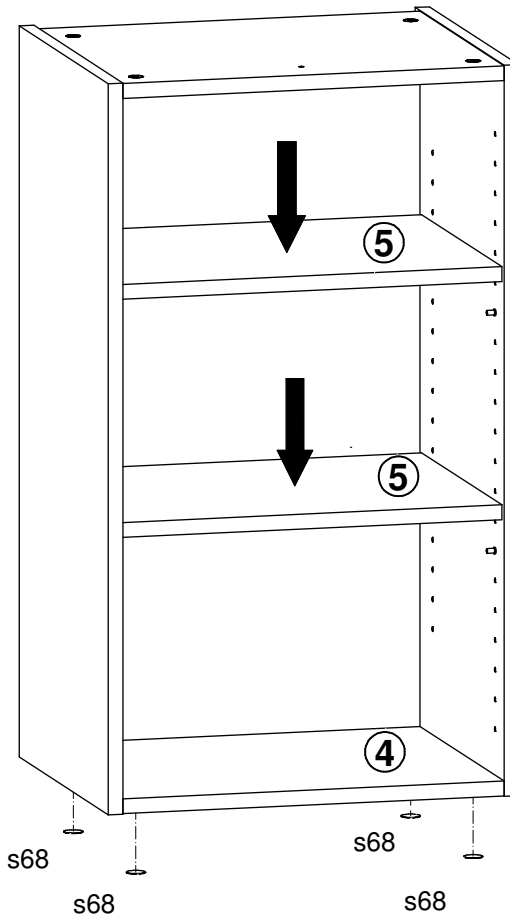
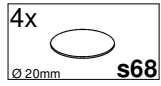

# 10

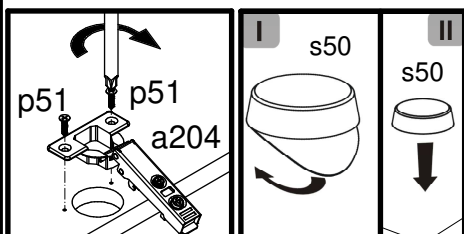
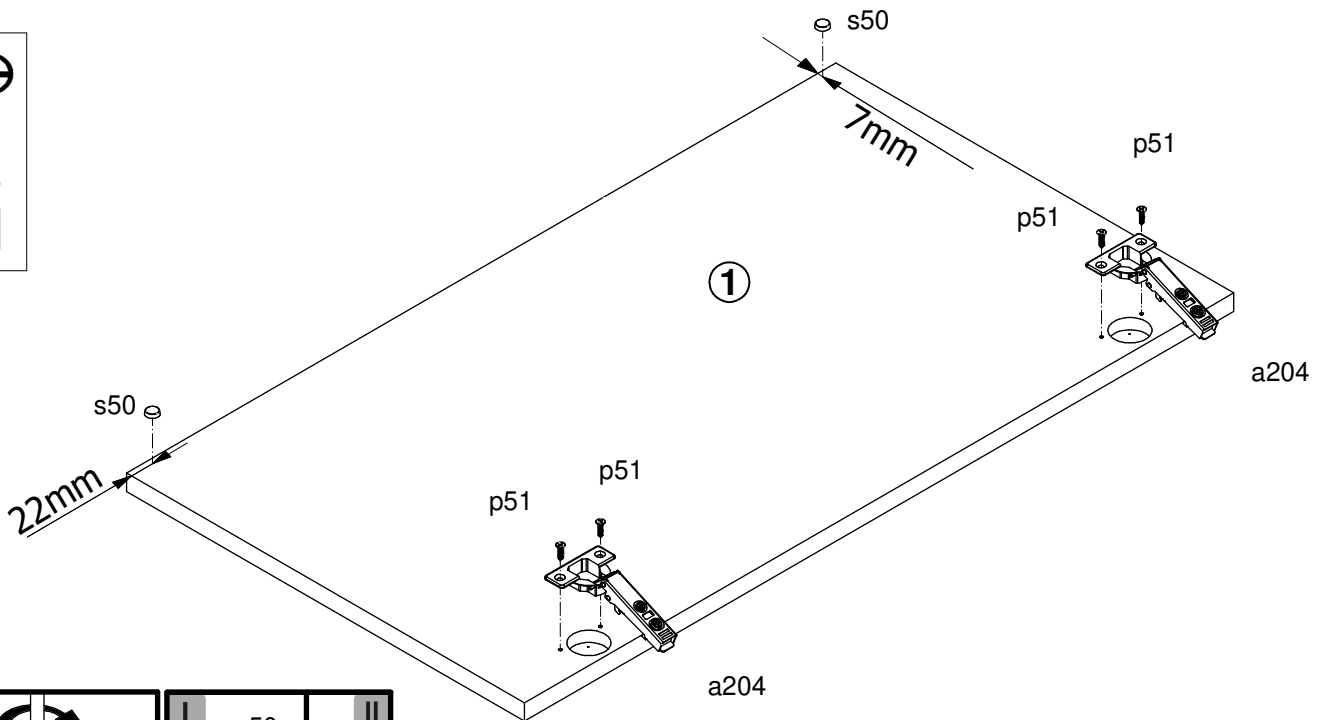
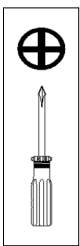
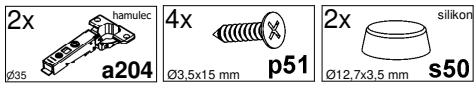

# 11

2x  b90 <sup>D2</sup>

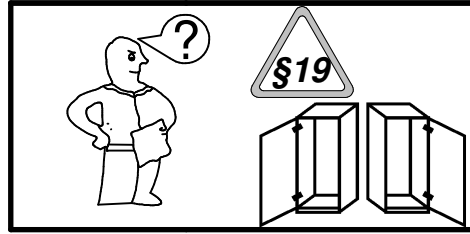

**L**

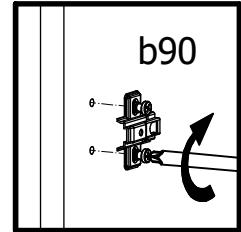
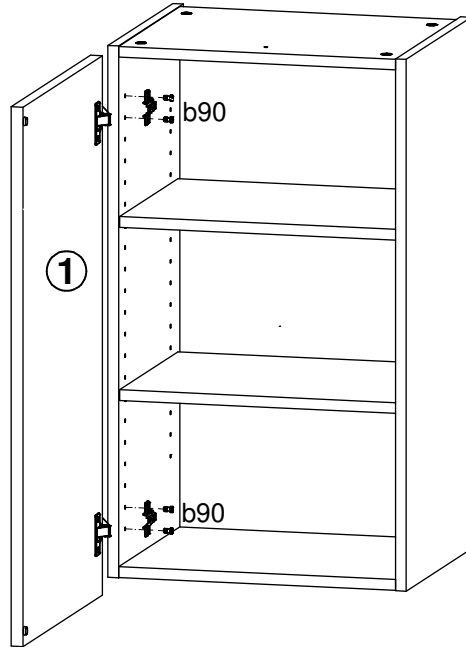

**P**

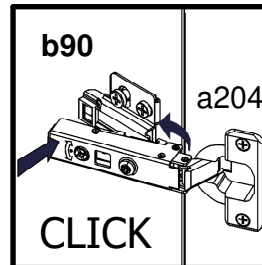
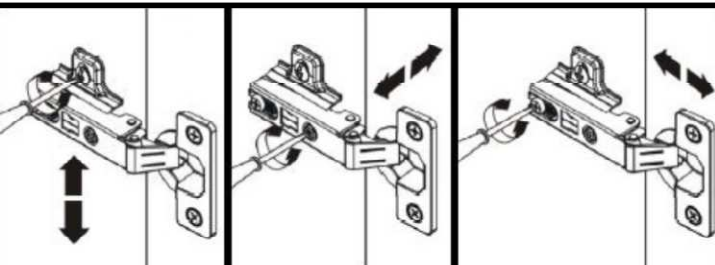
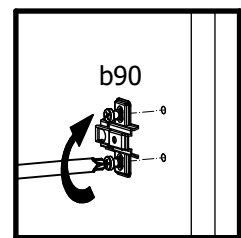
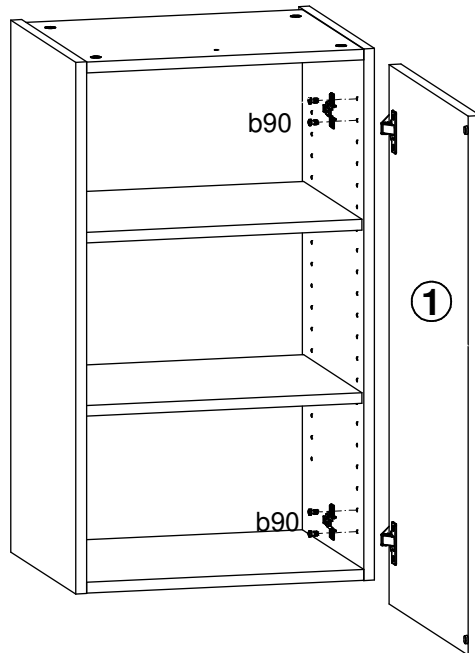

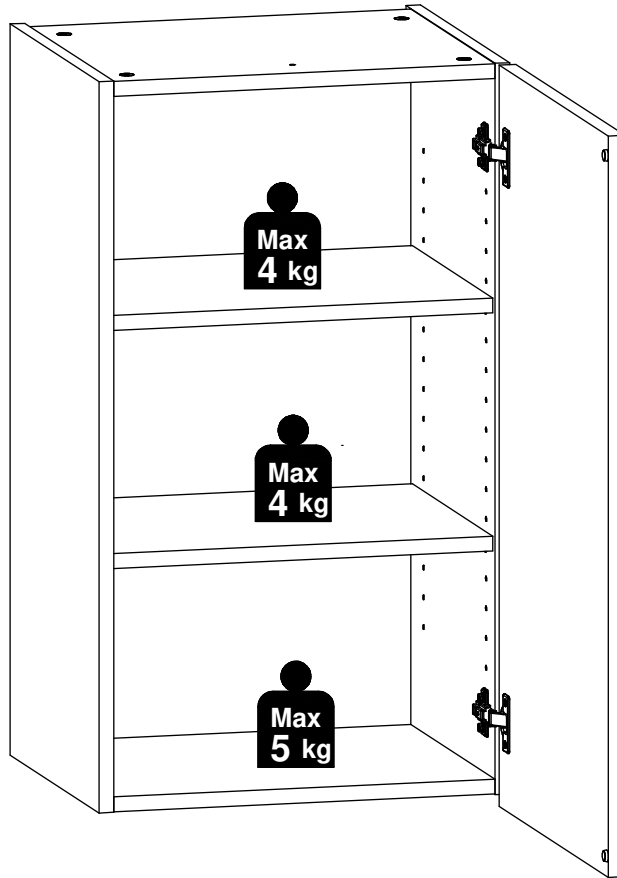

- NE JAMAIS UTILISER  
DEPRODUITS ABRASIFS:  
POUDRE, LAINE DACIER, SOLVANTS.  
- NE PAS MOUILLER



- NEVER USE ABRASIVE PRODUCTS  
OR SOLVENTS.  
DO NOT APPLY EXCESSIVE PRESSURE  
WHEN USING THE DAMP CLOTH.

	PAPER DECOR	SURFACES STRATIFIÉES	SURFACES LAQUÉES	BOIS VERNIS	TEXTILE CUIR
EAU SAVONNEUSE (SAVON NEUTRE)	●	●	●	●	●
EAU ADDINONNEF DE DETERGENT		●	●		
ENTRETIEN SPECIFIQUE FABRICANT					●

	PAPER DECOR	LAMINATED SURFACES	LACQUERED SURFACE	VARNISHED WOOD	LEATHER TEXTILE
SOAPY WATER (NEUTRAL SOAP)	●	●	●	●	●
WATER WITH DETERGENT		●	●		
SPECIFIC SUPPLIER CLEANING					●