

ASSEMBLY INSTRUCTIONS

25130004-01

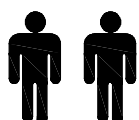

2 PERS.

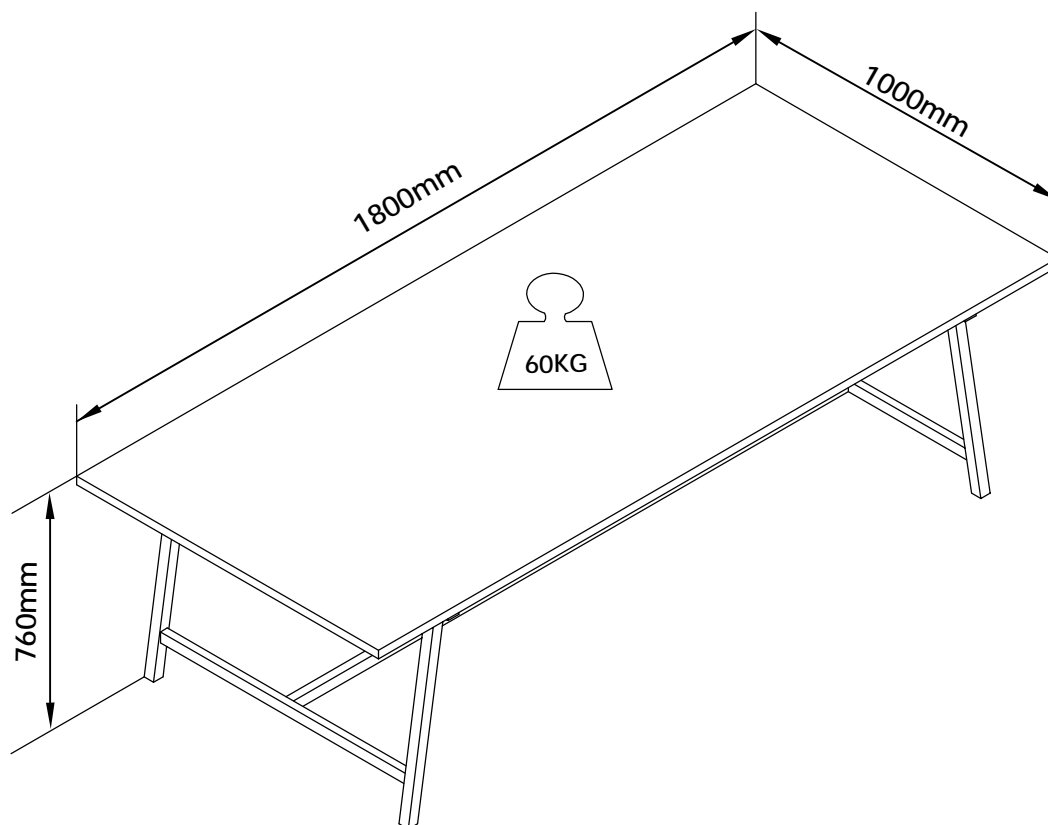
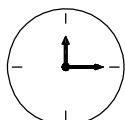



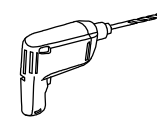
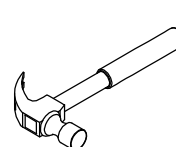
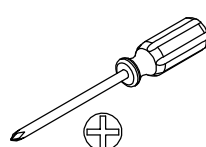
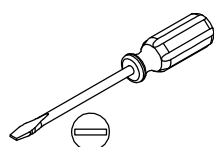



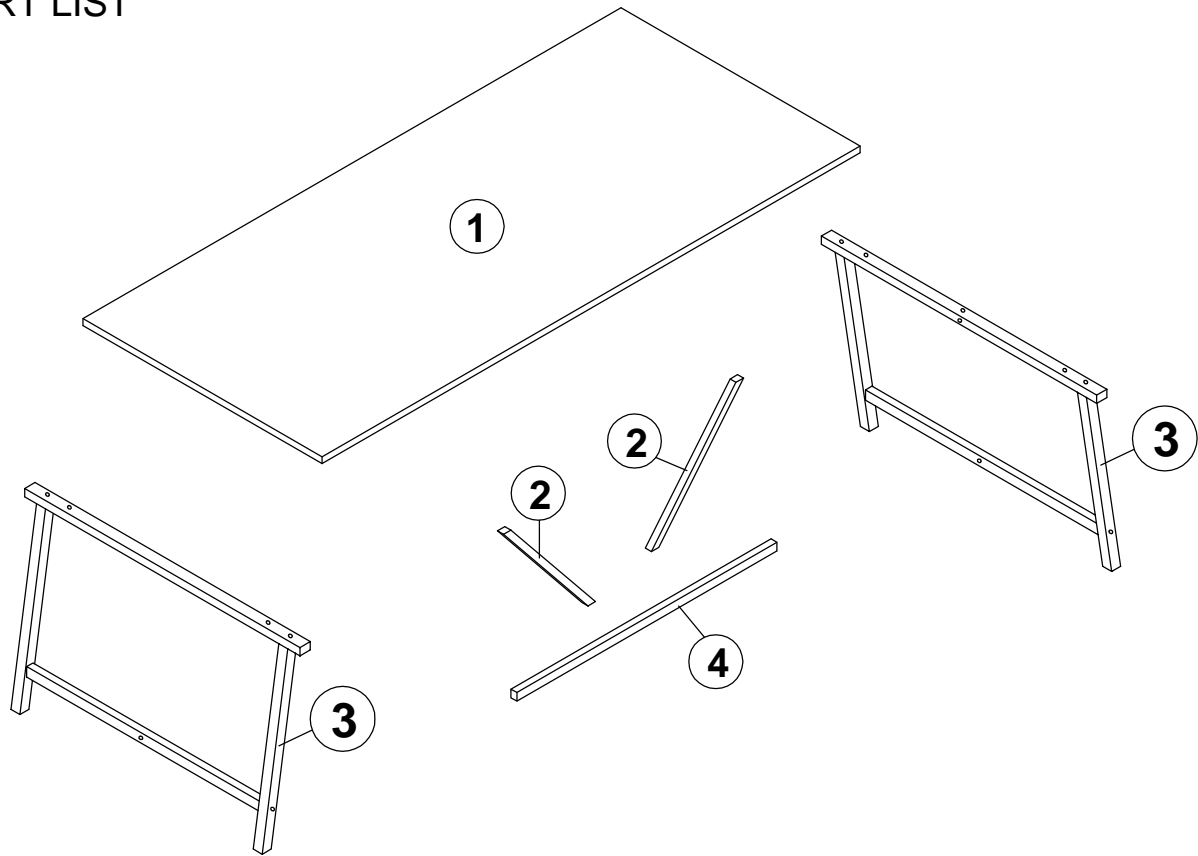

20 MIN



PART LIST





HARDWARE LIST

Part number	Image	Quantity
A	 40x8mm	× 6
B	 70x6mm	× 2
C	 12x10mm	× 2
D	 45x4mm	× 4
E	 × 6	× 6
F	 5mm	× 1
G	 40x10mm	× 4
H	 × 4	× 4
I	 4mm	× 1

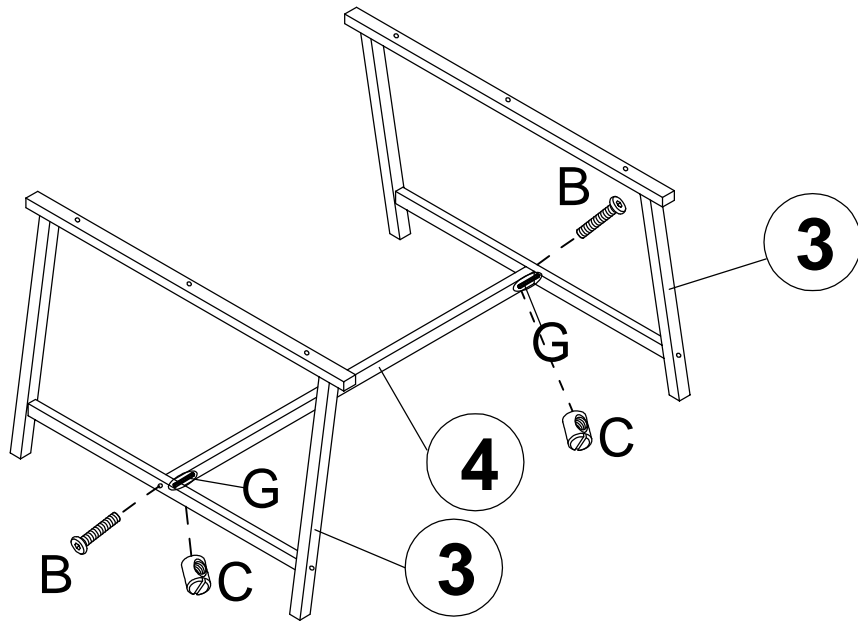
STEP 1





B	X2
	
70x6mm	

C	X2
	
12x10mm	

G	X2
	
40x10mm	

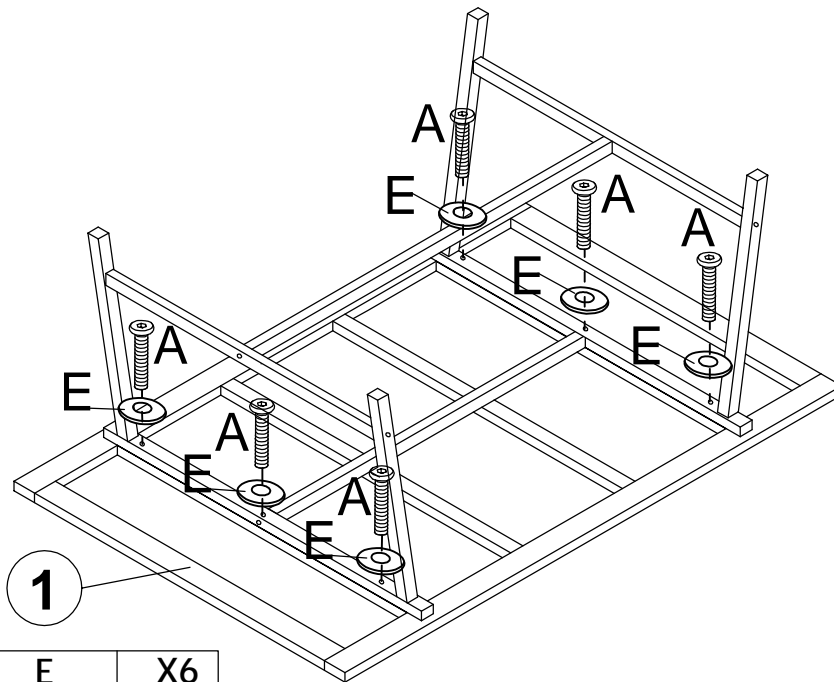
STEP 2





A	X6
	
40x8mm	

E	X6
	

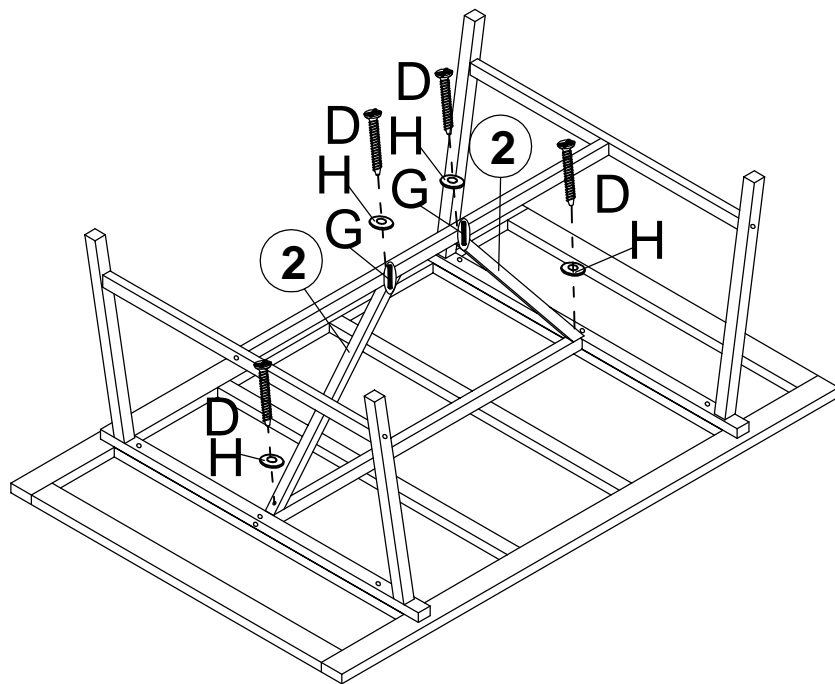
STEP 3



D	X4	G	X2	H	X4
					
45x4mm		40x10mm			

STEP 4

