

# Bree Typ 20

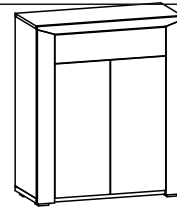

	848
	1006
	377





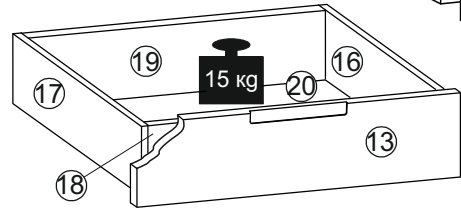
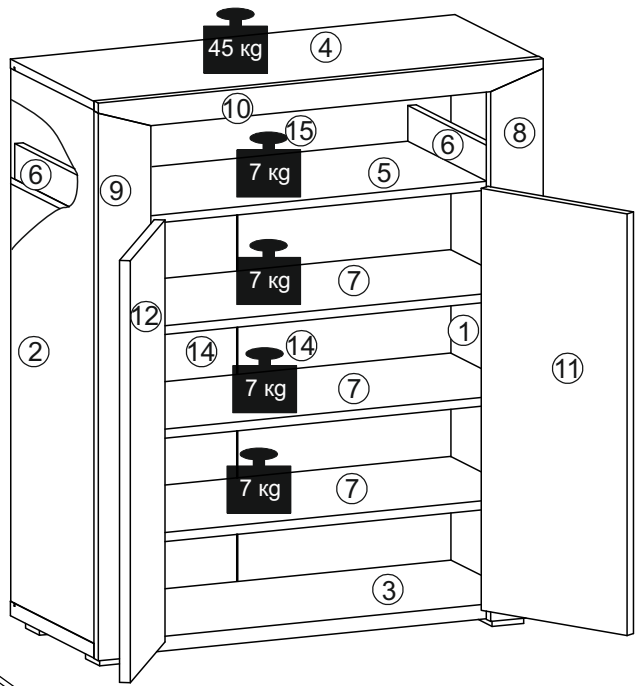
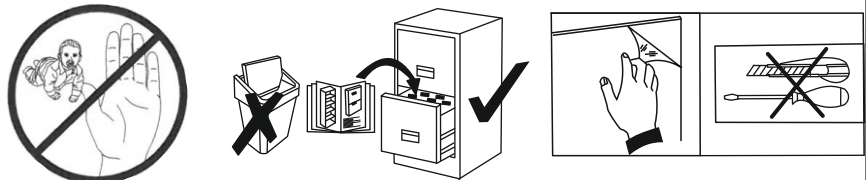

A x19	B x19	C x24	D x12	E x1	F x22	G x5	H x6	J x2	K x12
L x1	M x4	N x4	P x16	R x19	O x1	Q x4	T x4	U x2	W x1
X x4	S x4	T x4	Y x12	Z x7	V x5	a x5	b x24	c x4	d x1

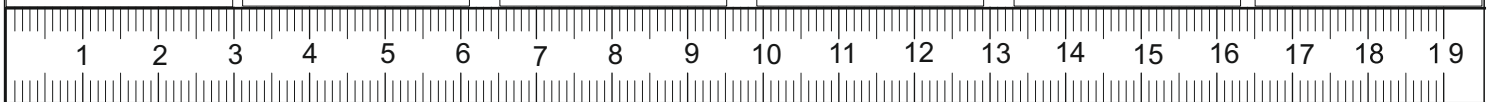
--	--	--	--	--	--	--	--	--	--

①	953x358x16	1	2	
②	953x358x16	1	2	
③	848x358x26	1	1	
④	848x358x16	1	1	
⑤	814x337x16	1	1	
⑥	337x64x16	2	1	
⑦	813x336x16	3	1	
⑧	979x100x19	1	2	
⑨	979x100x19	1	2	
⑩	848x50x19	1	2	
⑪	754x321x19	1	2	
⑫	754x321x19	1	2	
⑬	644x161x19	1	2	
⑭	752x410x4	2	2	
⑮	207x822x4	1	2	
⑯	300x122x16	1	1	
⑰	300x122x16	1	1	
⑱	608x108x16	1	1	
⑲	608x108x16	1	1	
⑳	616x298x4	1	2	





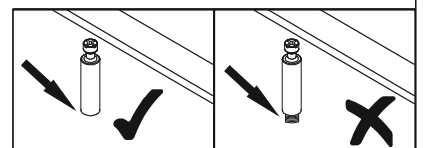
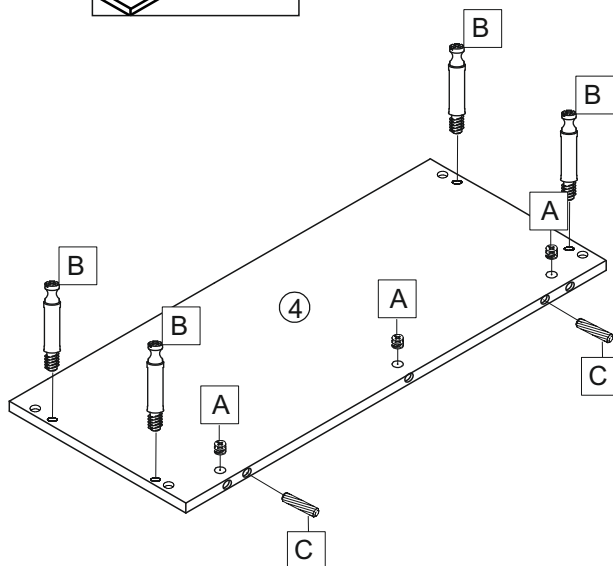
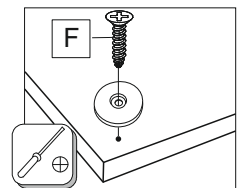
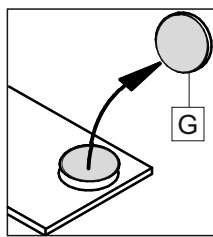
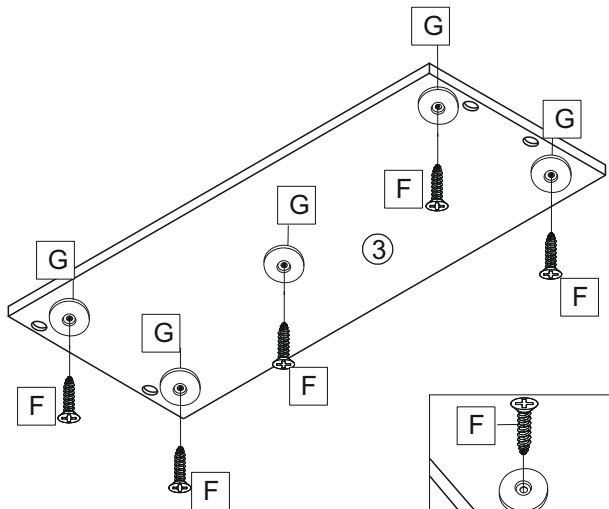
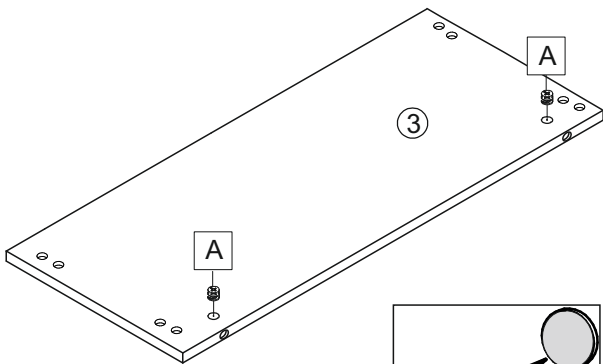
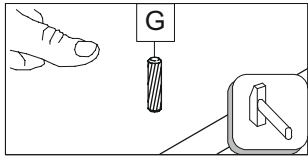
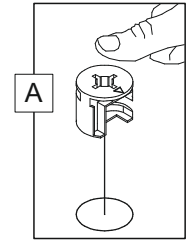
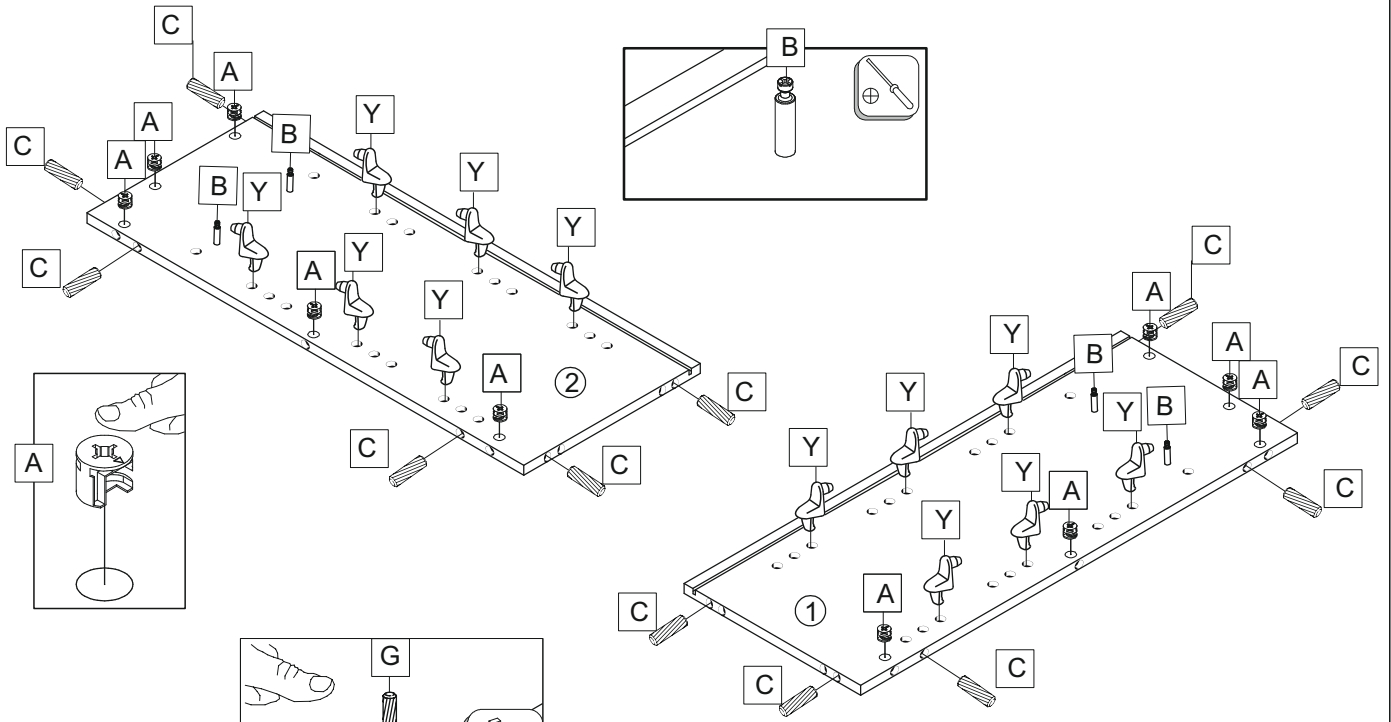
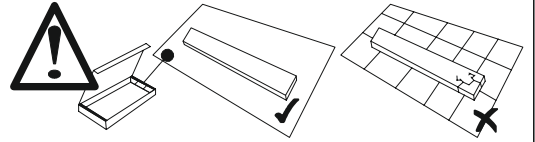

		 8x30	 3,5x16		
A x15	B x8	C x14	F x5	G x5	Y x12





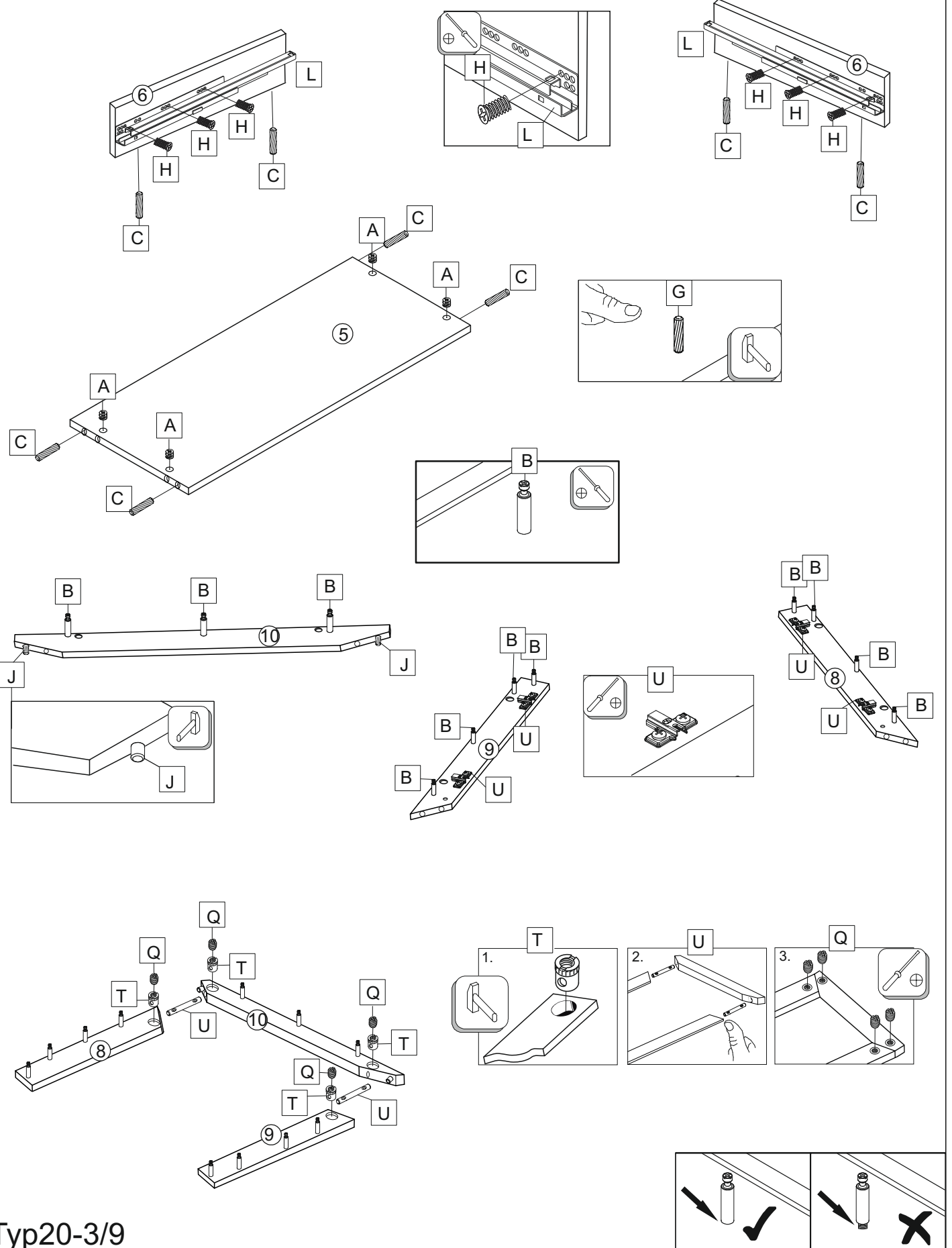
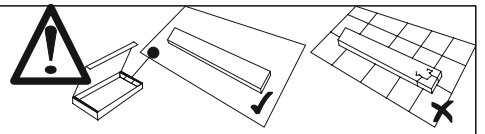

Typ20-2/9

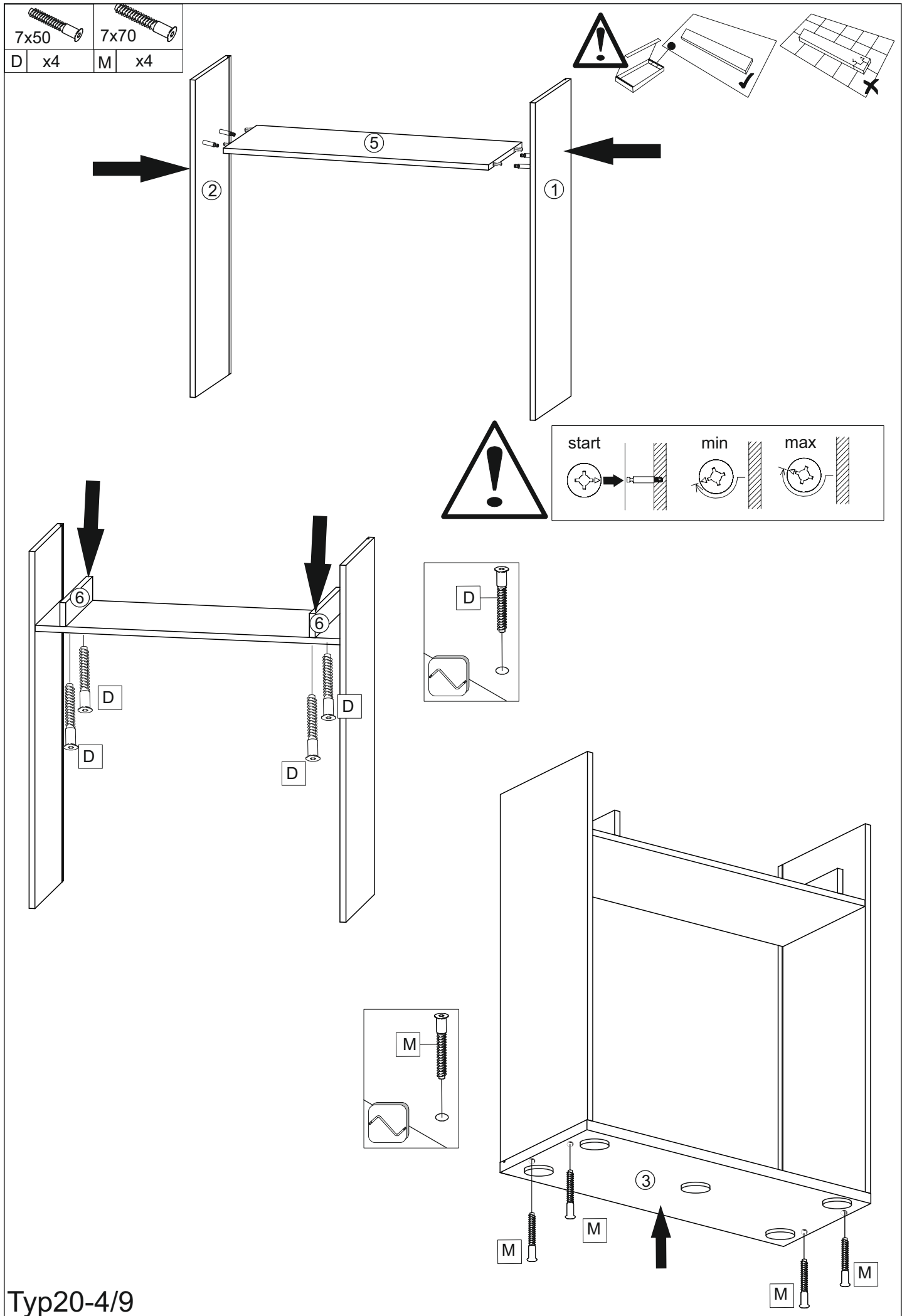
A x4	B x11	C x4	H x6	L x1k	J x2
T x4	Q x4	T x4	U x2		

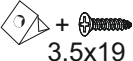





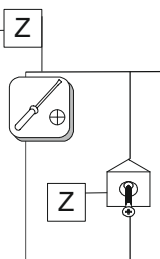
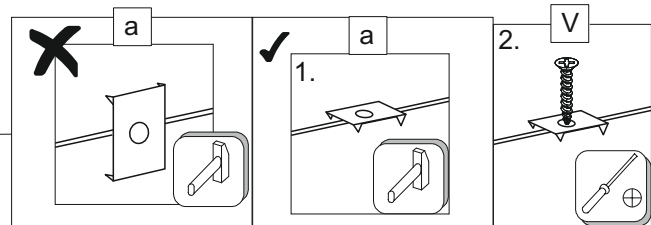
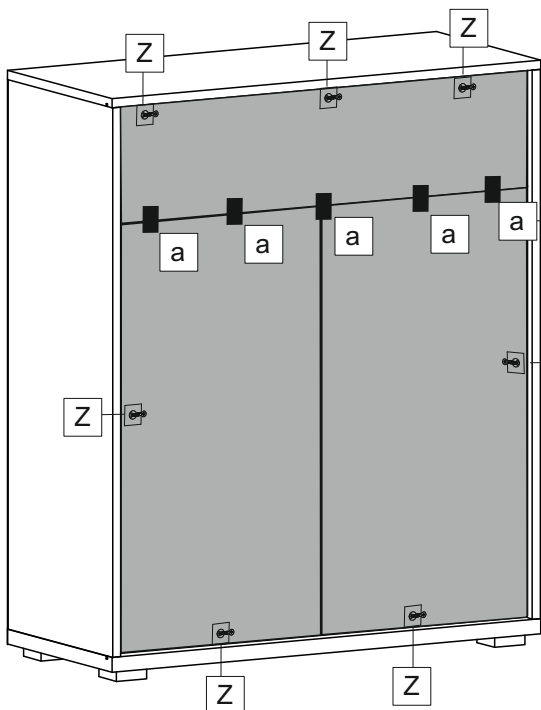
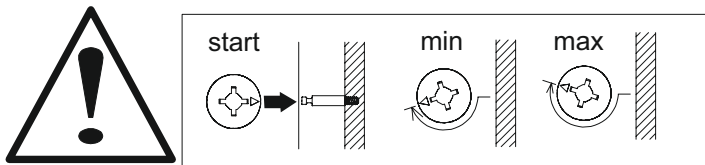
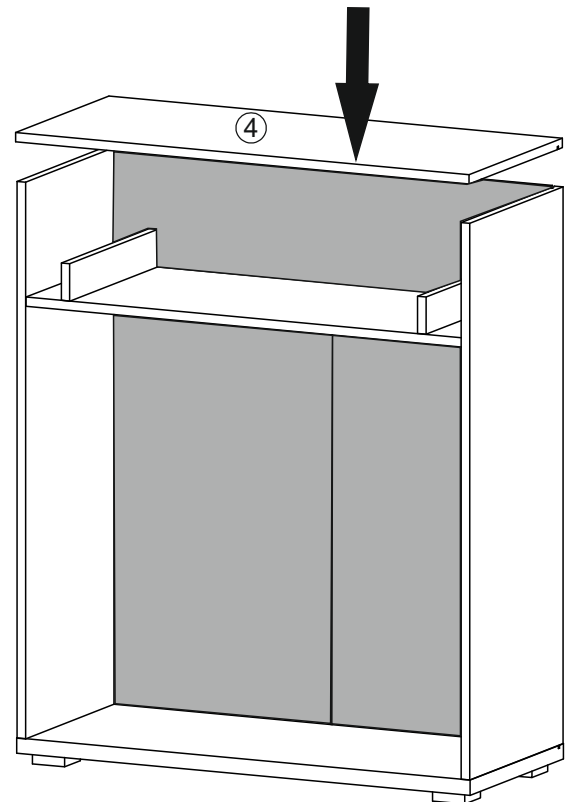
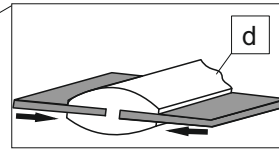
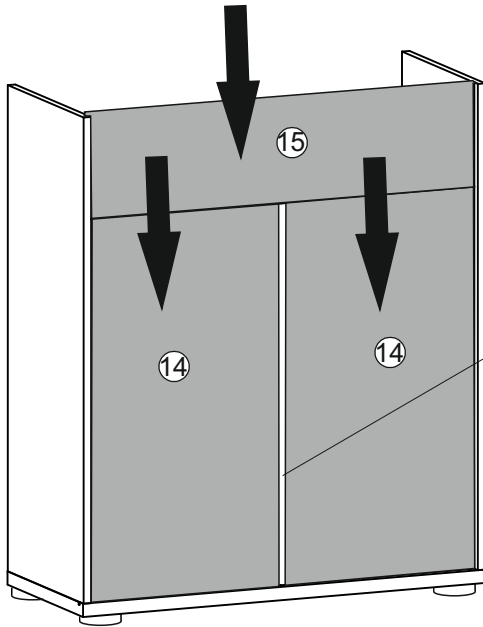
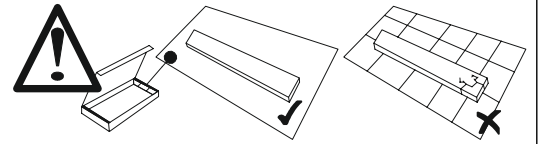





 + 			
3,5x19	3,5x19	L=739	
Z x7	V x5	a x5	d x1

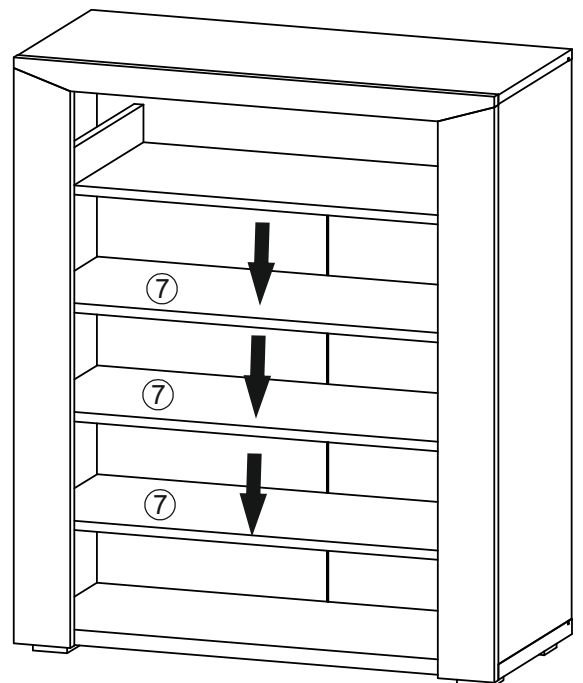
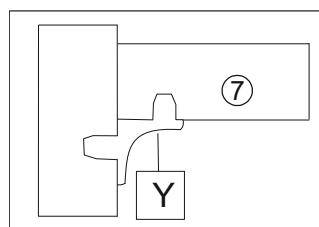
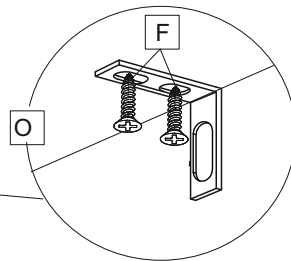
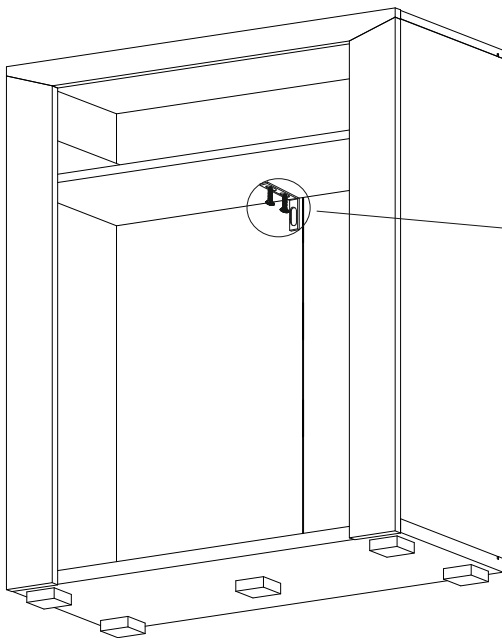
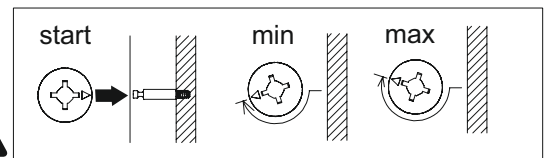
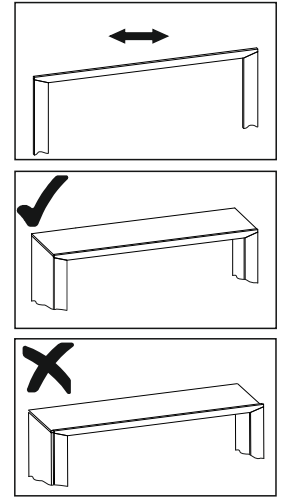
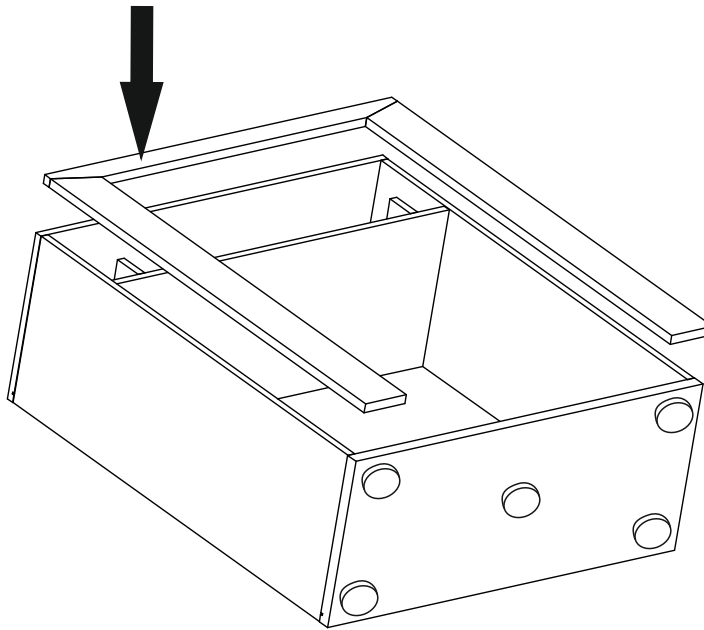
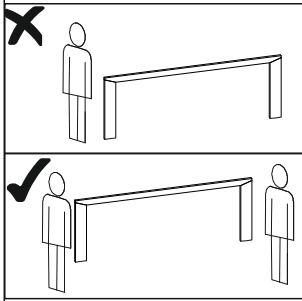
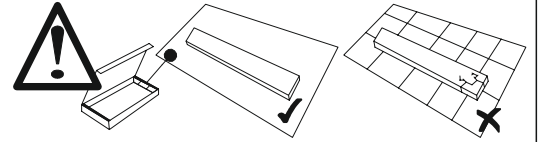





Typ20-5/9

	3,5x16			∅5
F	x2	O	x1	b
				x24

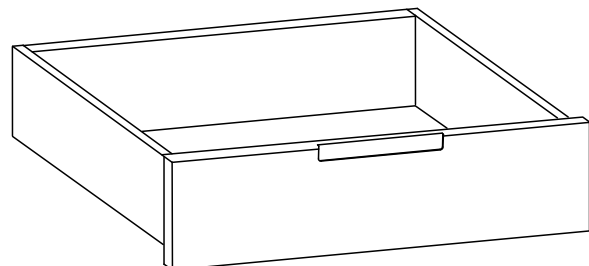
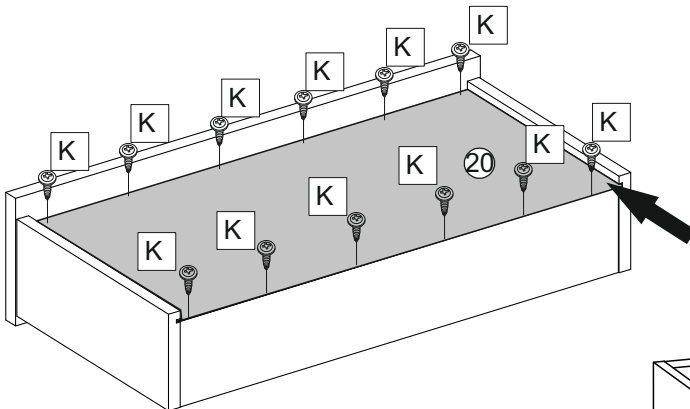
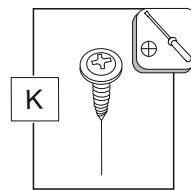
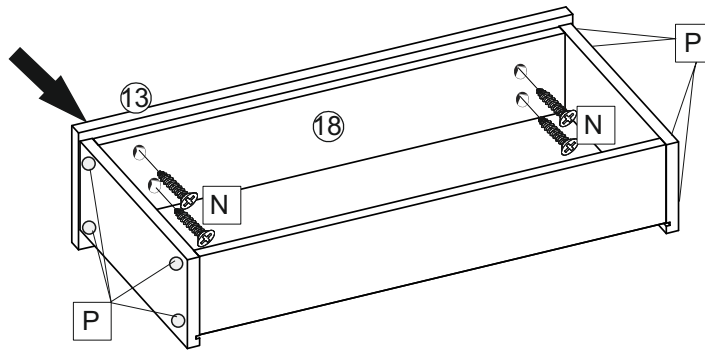
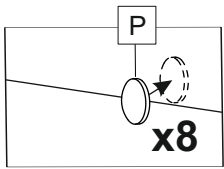
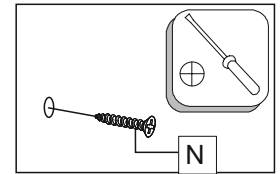
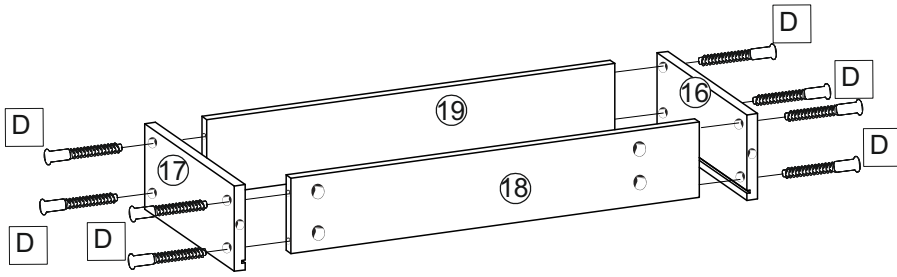
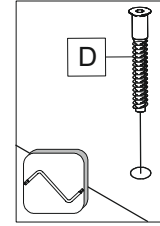
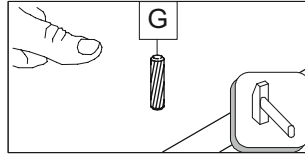
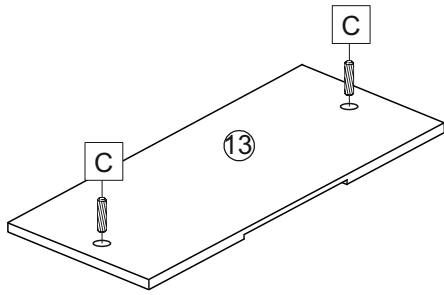
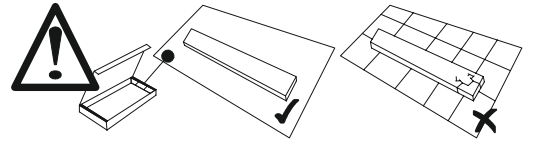



				
C x2	D x8	K x12	N x4	P x8

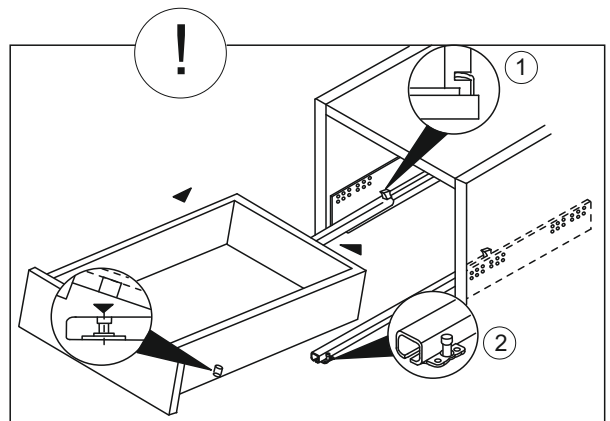
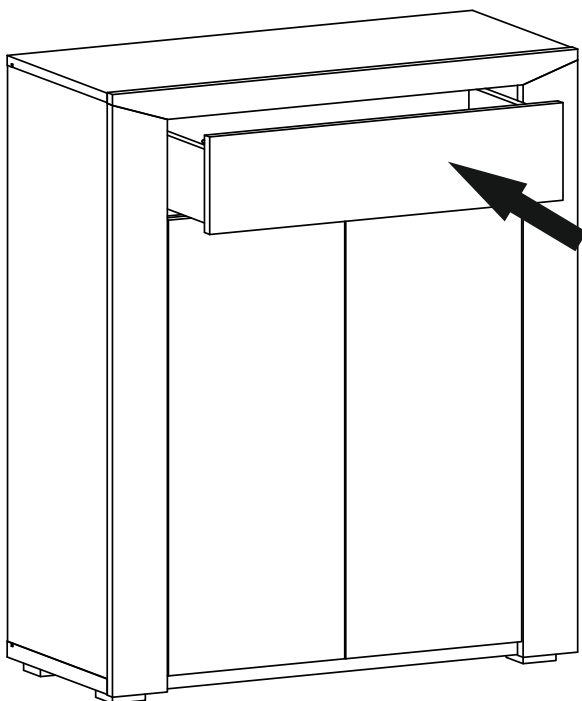
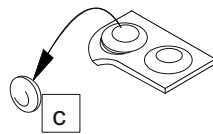
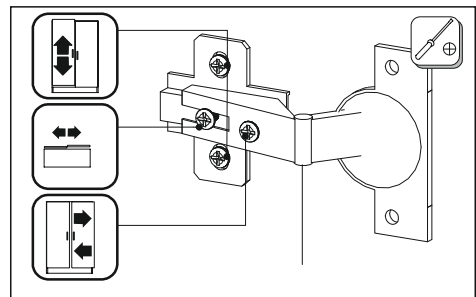
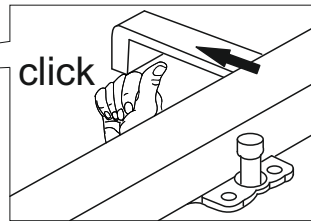
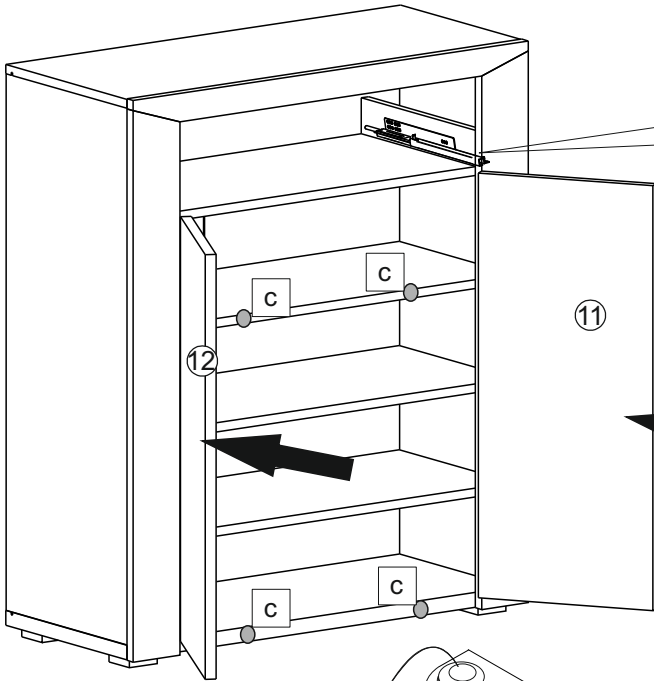
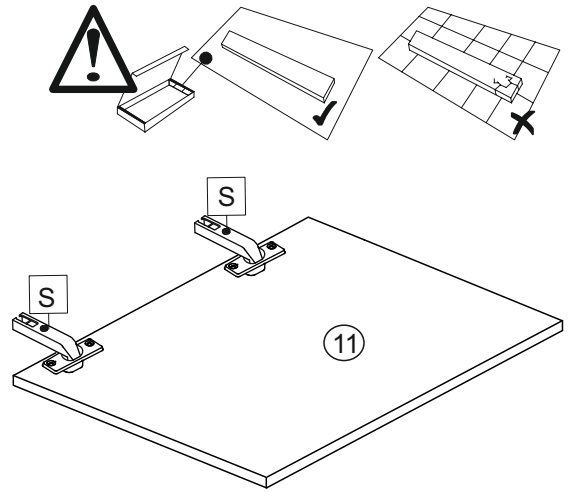
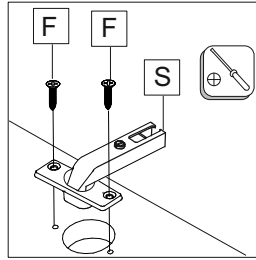
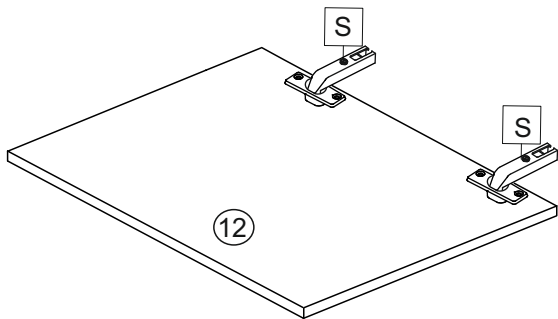

		
3,5x16		
F x8	S x4	c x4





 5,0x70	 $\phi 14$	 $\phi 18$
E x1	P x8	R x19

