

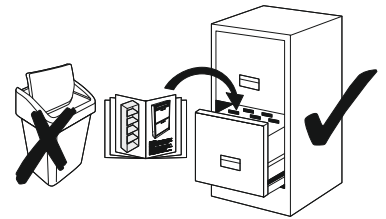

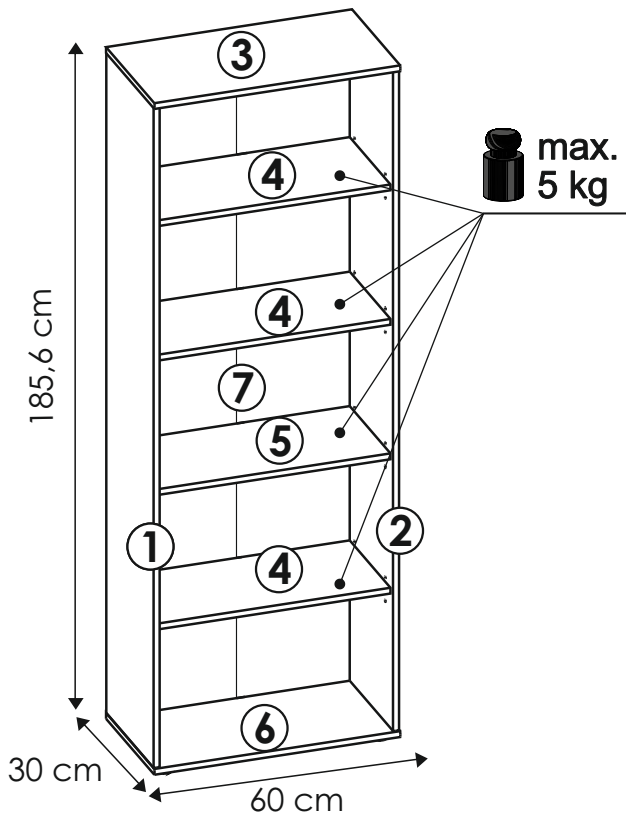









1803

JOSEF 6

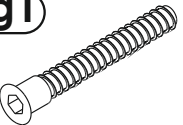
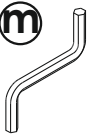

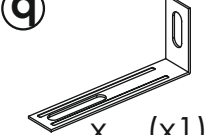
a1  8x35 x....(x8)	d2  x... (x12)	e0  x.... (x4)	e1  x.... (x4)	e2  x.... (x4)	f1  x.... (x4)	f2  x.... (x4)	g0  x.... (x4)	g1  7x50 x.... (x4)	m  x.... (x1)
i2  4x16 x... (x1)	o1  3,5x22 x.... (x4)	q  x.... (x1)	r4  x.... (x12)	z  x.... (x1)					

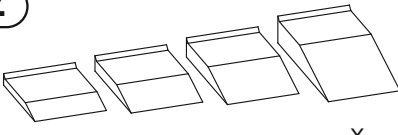
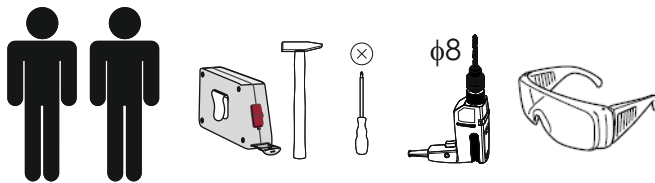

1

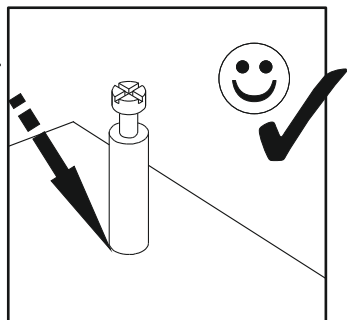
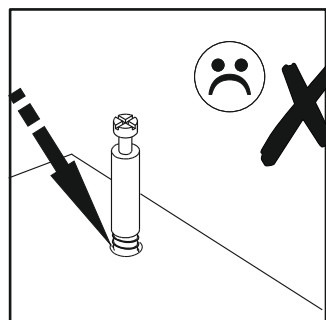
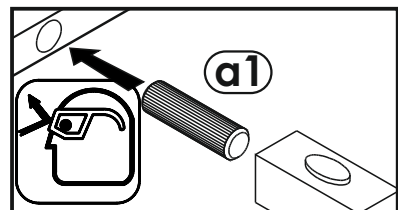
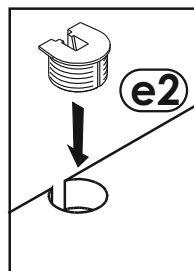
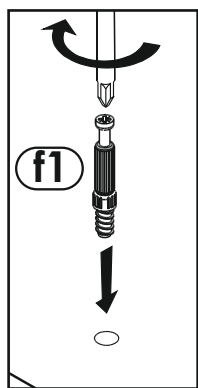
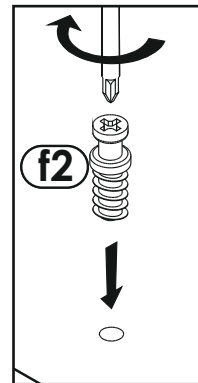
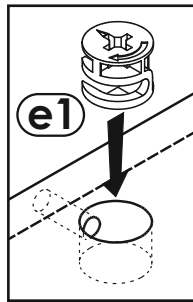
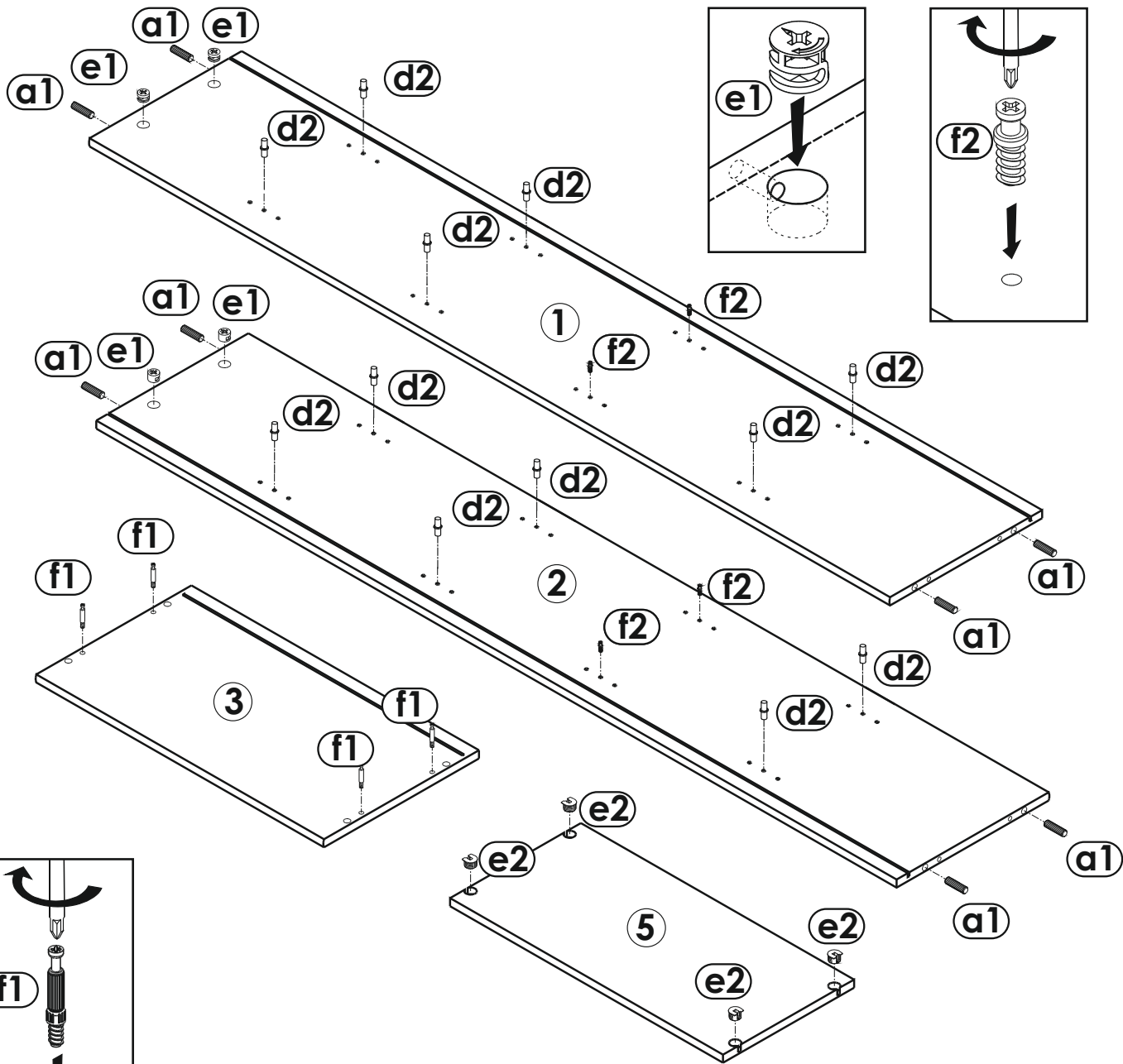
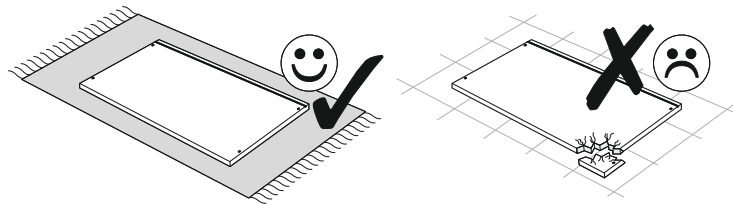

2

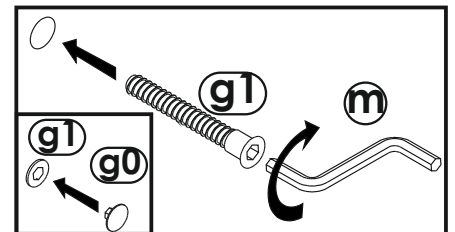
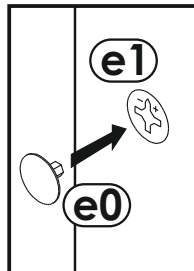
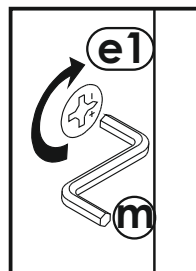
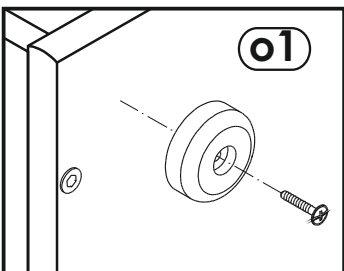
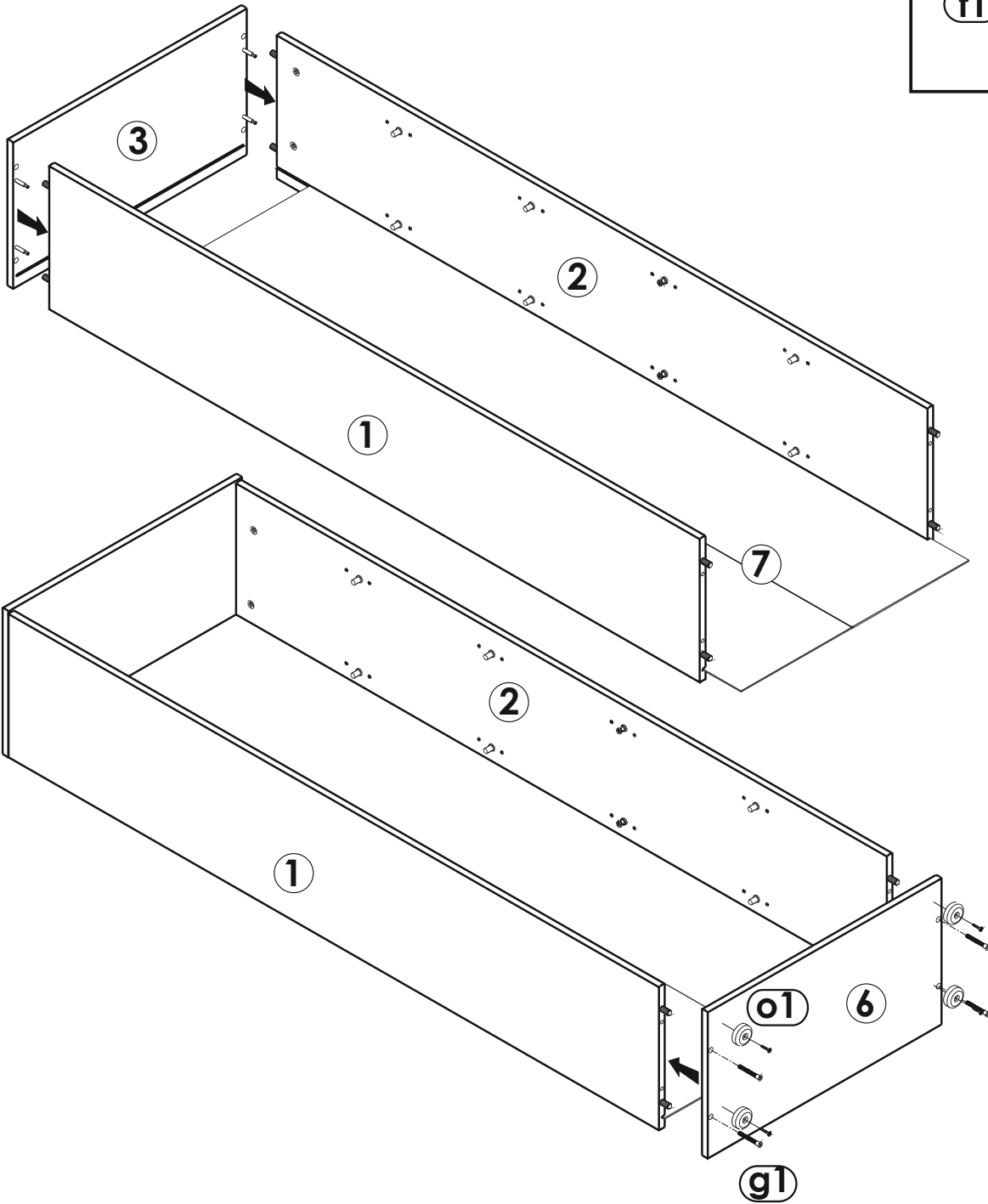
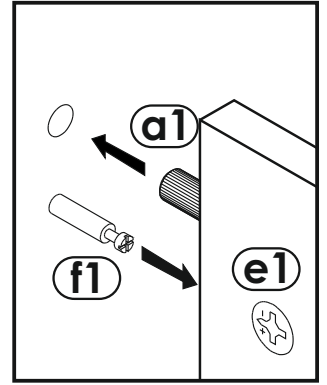
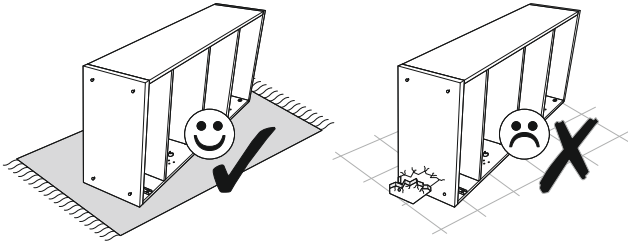

3
▼

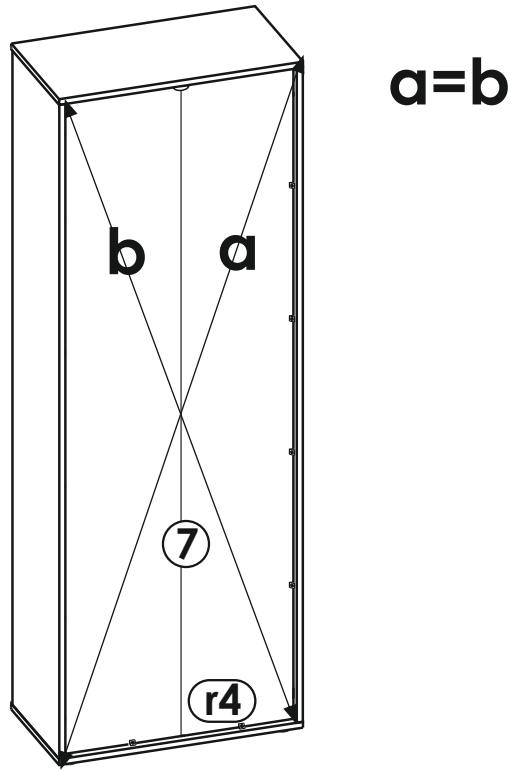
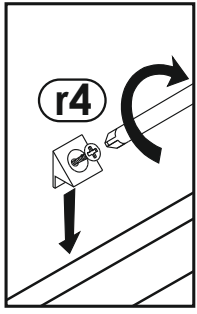

4
▼

