

## AVENSIS NEW 03B

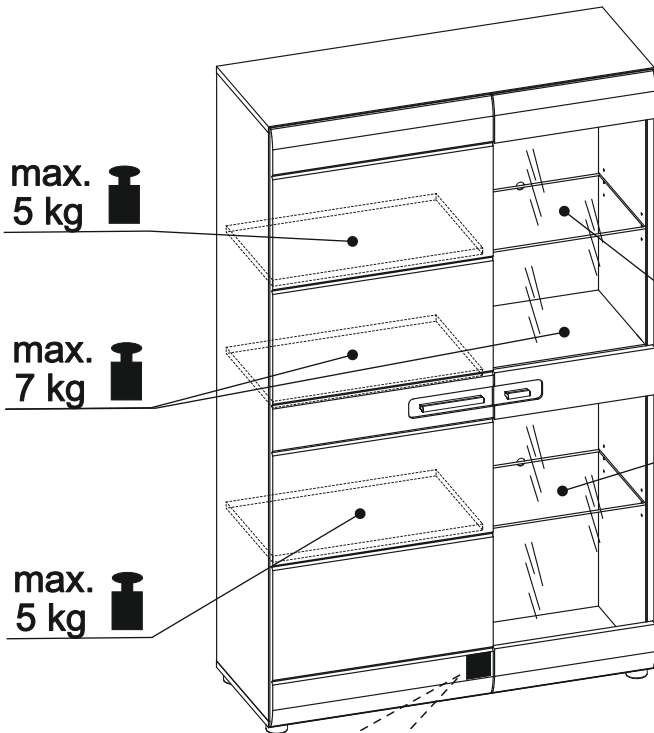

**A**  
(1A - 9A)

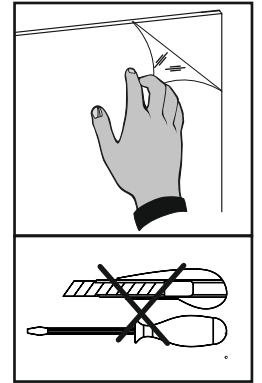
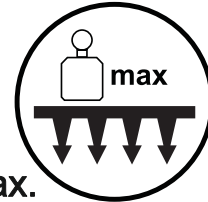
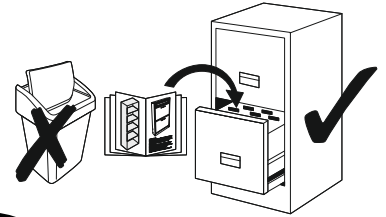

max. 7 kg

max. 5 kg

max. 3 kg

max. 5 kg

max. 7 kg

max. 5 kg

**B**  
(1B - 9B)

max. 3 kg



- |        |        |        |        |
|--------|--------|--------|--------|
| ① - C2 | ⑥ - C1 | ⑪ - C1 | ⑯ - C2 |
| ② - C1 | ⑦ - C1 | ⑫ - C1 |        |
| ③ - C2 | ⑧ - C1 | ⑬ - C1 |        |
| ④ - C1 | ⑨ - C1 | ⑭ - C2 |        |
| ⑤ - C1 | ⑩ - C2 | ⑮ - C2 |        |

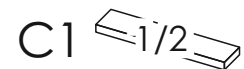

# AVENSIS NEW 03B

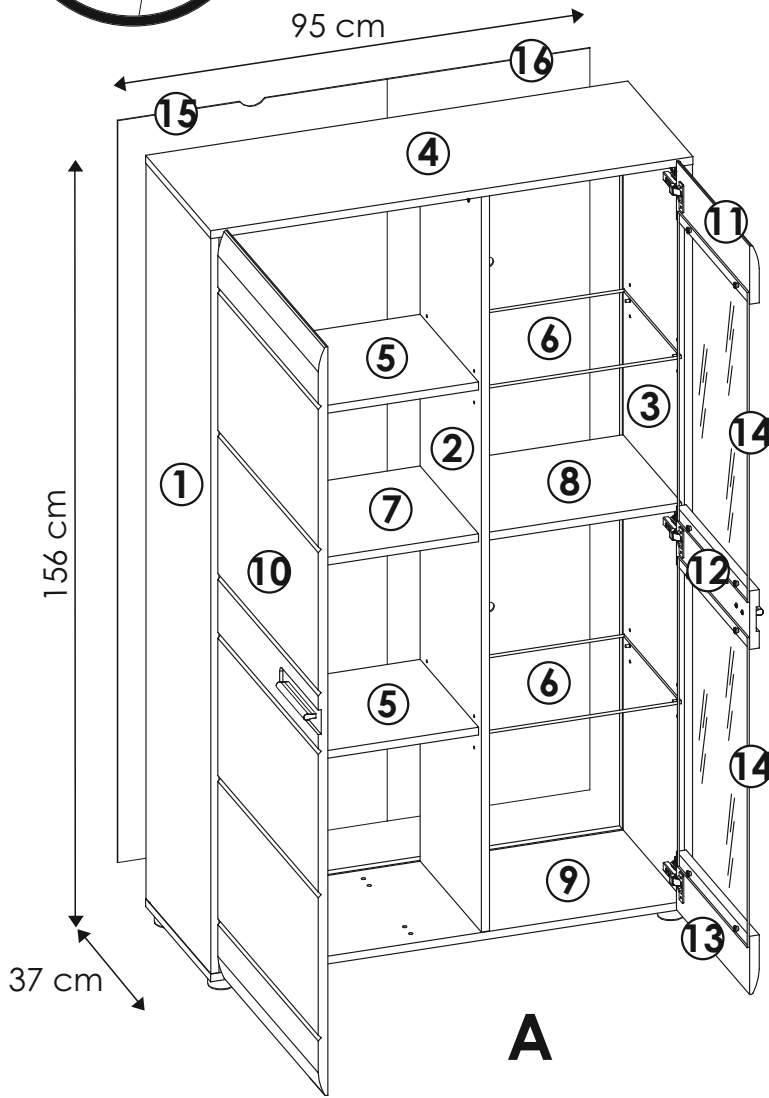

<b>a1</b> 8x35 x...(x16)	<b>a3</b> 8x60 x...(x2)	<b>bc0 + bo1</b> x...(x6)
<b>c1</b> Euro 4x13 x...(x12)	<b>d2</b> x...(x16)	<b>bc0</b> <b>bo1</b> x...(x6)
<b>e0</b> x...(x14)	<b>e1</b> x...(x14)	<b>et</b> LUCA BESSONI x...(x1)
<b>f1</b> x...(x10)	<b>f3</b> 7x76 x...(x2)	
<b>g0</b> x...(x6)	<b>g1</b> 7x50 x...(x6)	<b>h2</b> x...(x1)
<b>h1</b> x...(x1)	<b>i2</b> 4x16 x...(x9)	<b>i4</b> 3,5x27 x...(x4)
<b>i10</b> 3,5x22 x...(x5)	<b>i10</b> x2 x...(x1)	<b>m</b> x...(x1)
<b>n1</b> 3x16 x...(x5)	<b>o15</b> x...(x5)	<b>p0</b> x...(x2)
	<b>p9</b> ø8 x...(x6)	<b>p15</b> x...(x2)
<b>q9</b> x...(x1)	<b>s13</b> x...(x1)	<b>r1</b> x...(x5)
		<b>r3</b> x...(x8)
<b>r4</b> x...(x10)	<b>z</b> x...(x1)	

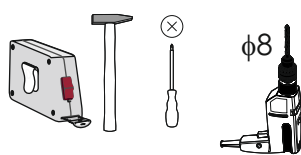
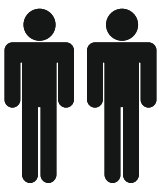

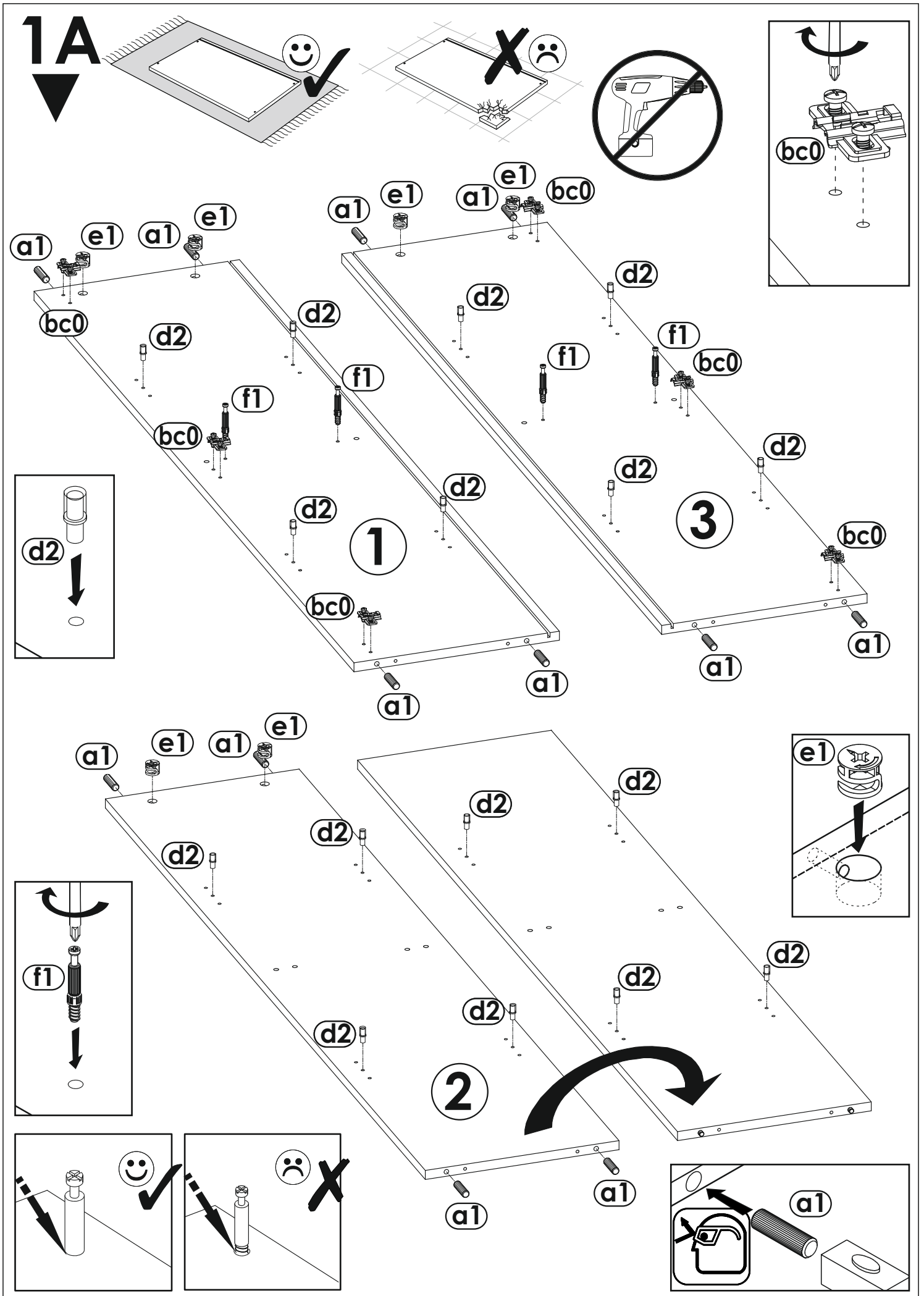

2A

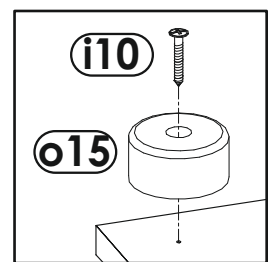
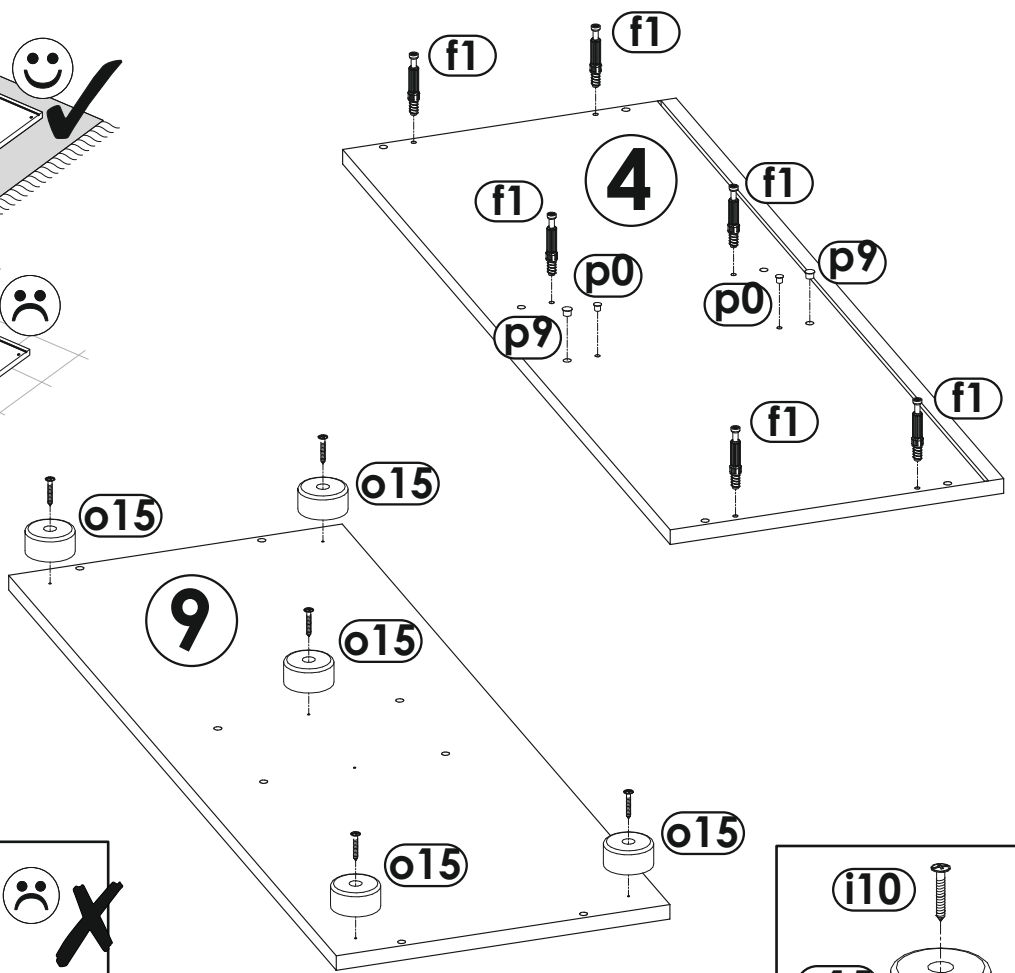
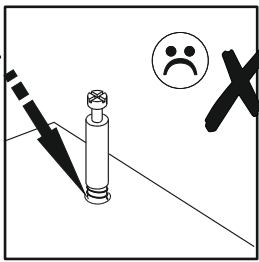
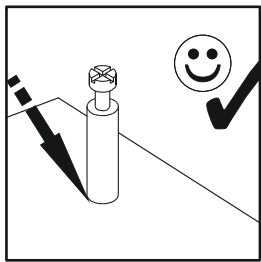
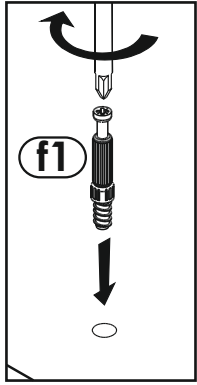
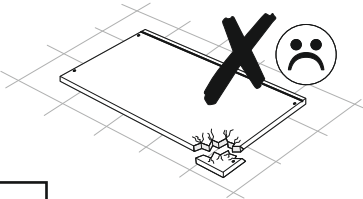
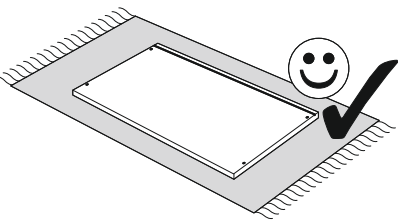

3A

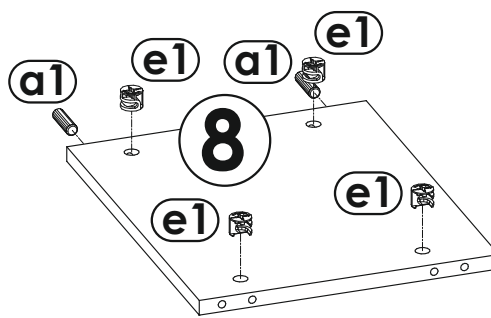
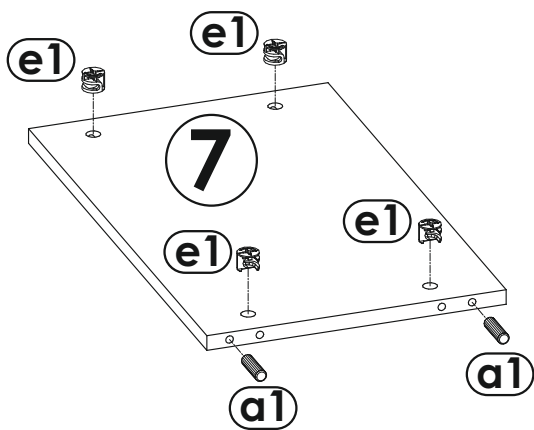
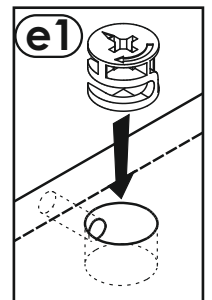
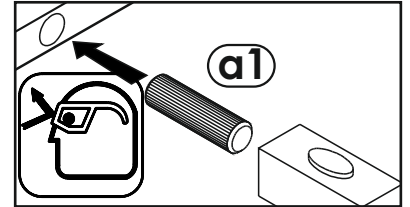
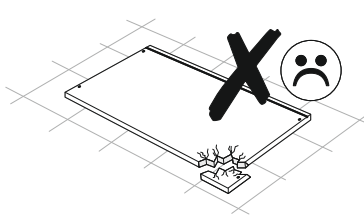
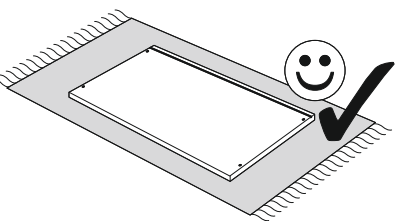

4A  
▼

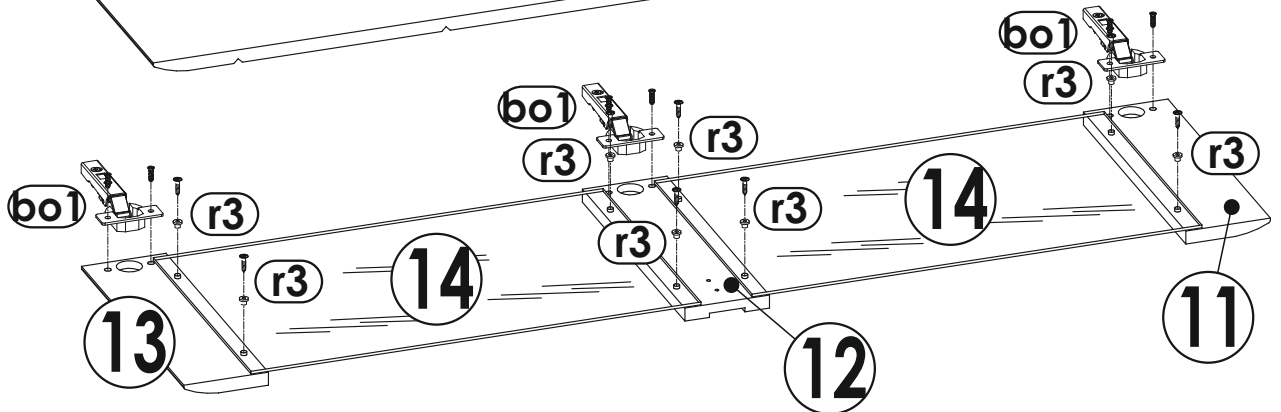
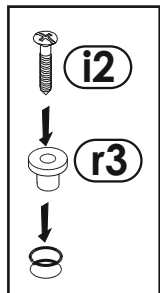
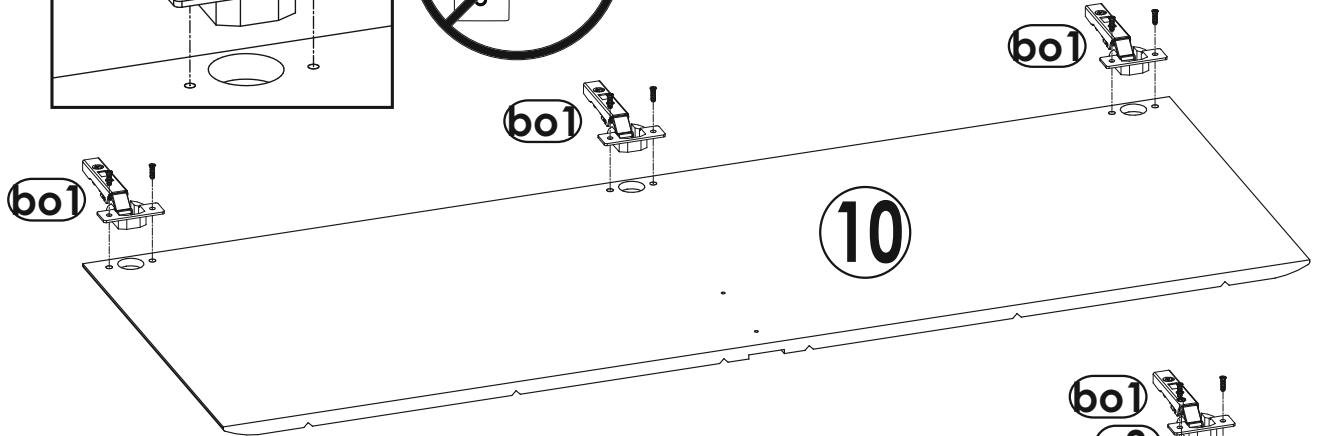
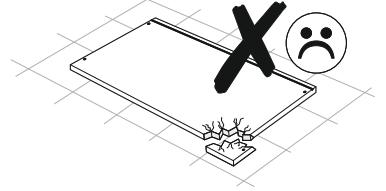
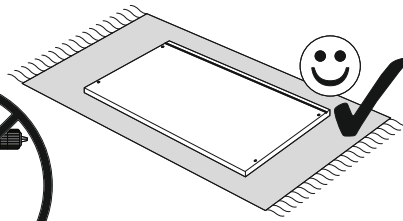
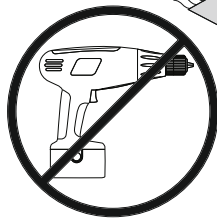
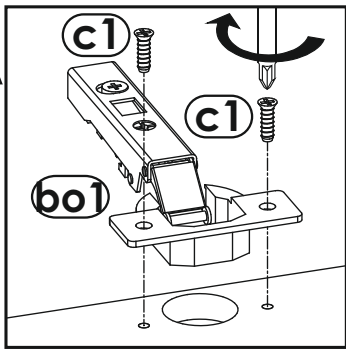

5A  
▼

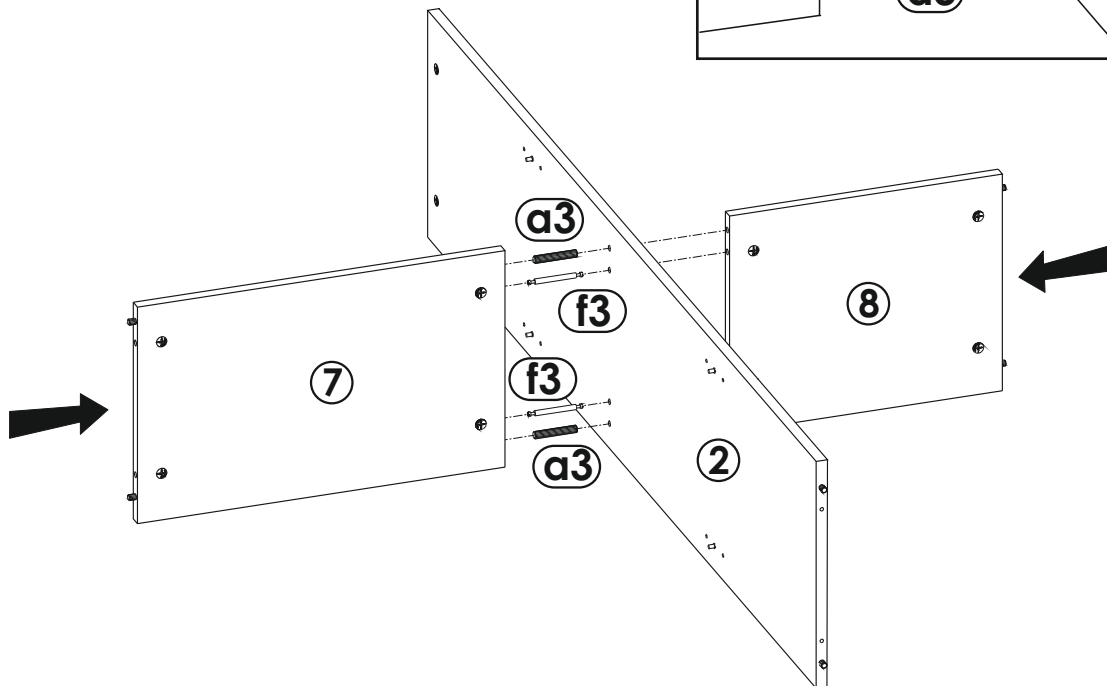
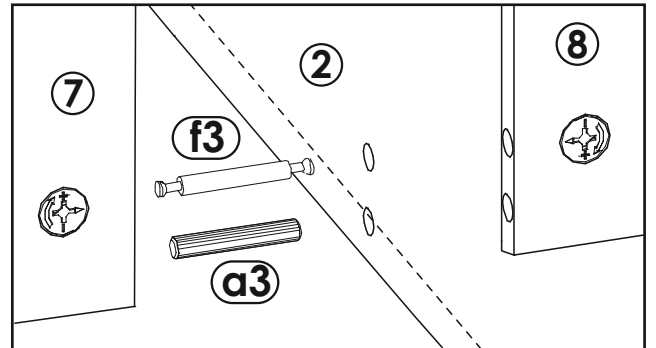
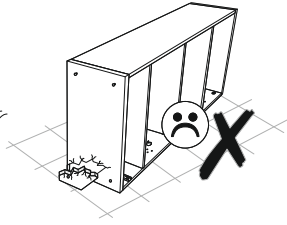
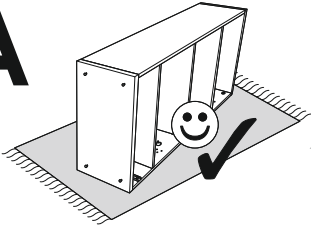

# 6A

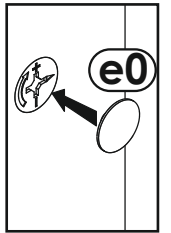
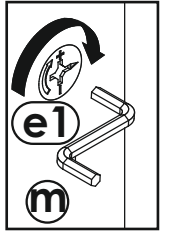
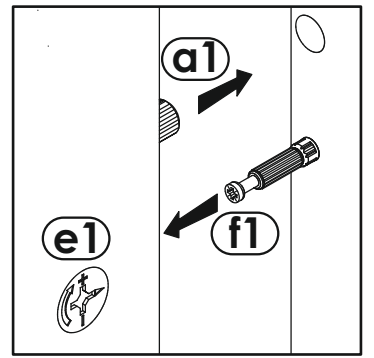
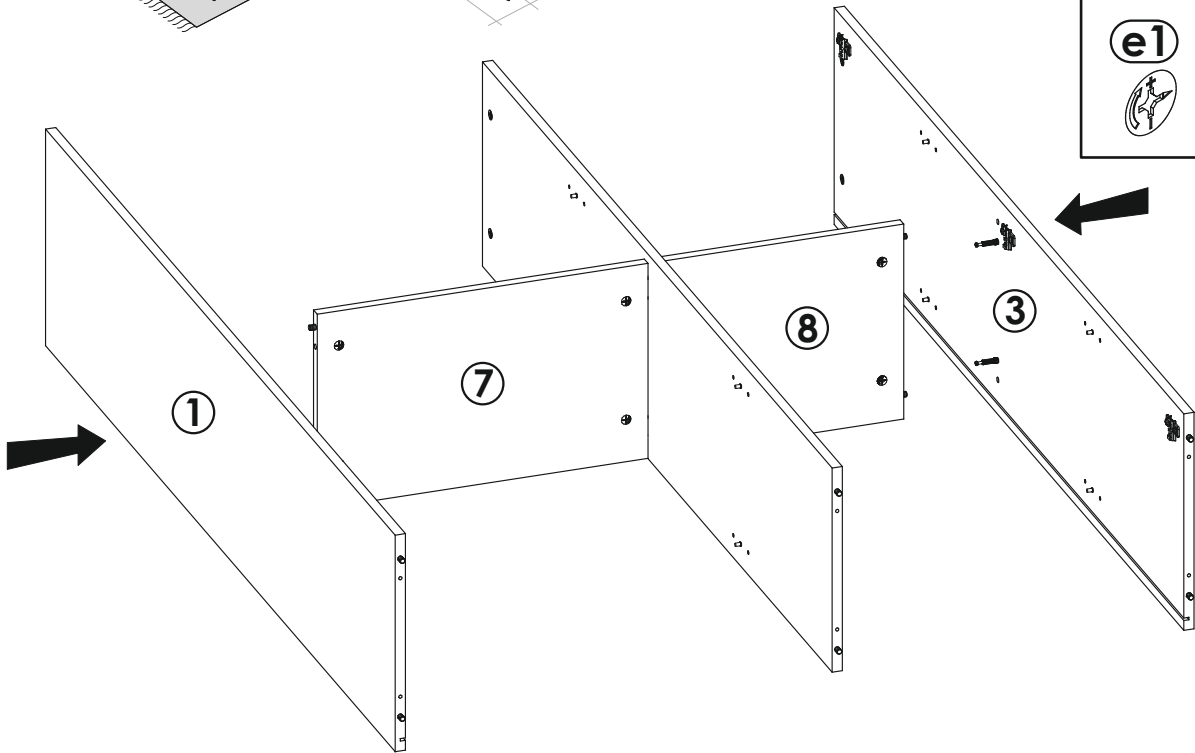
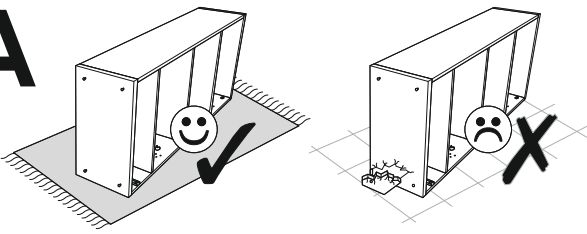

# 7A

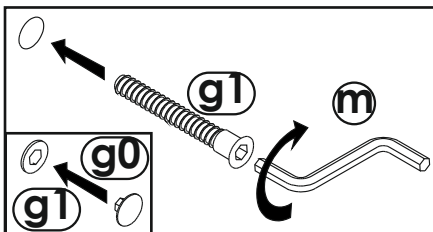
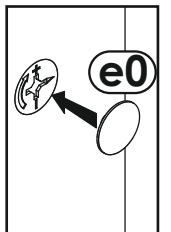
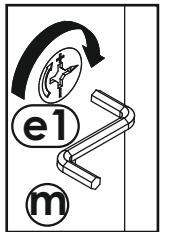
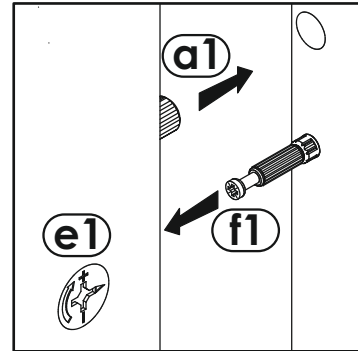
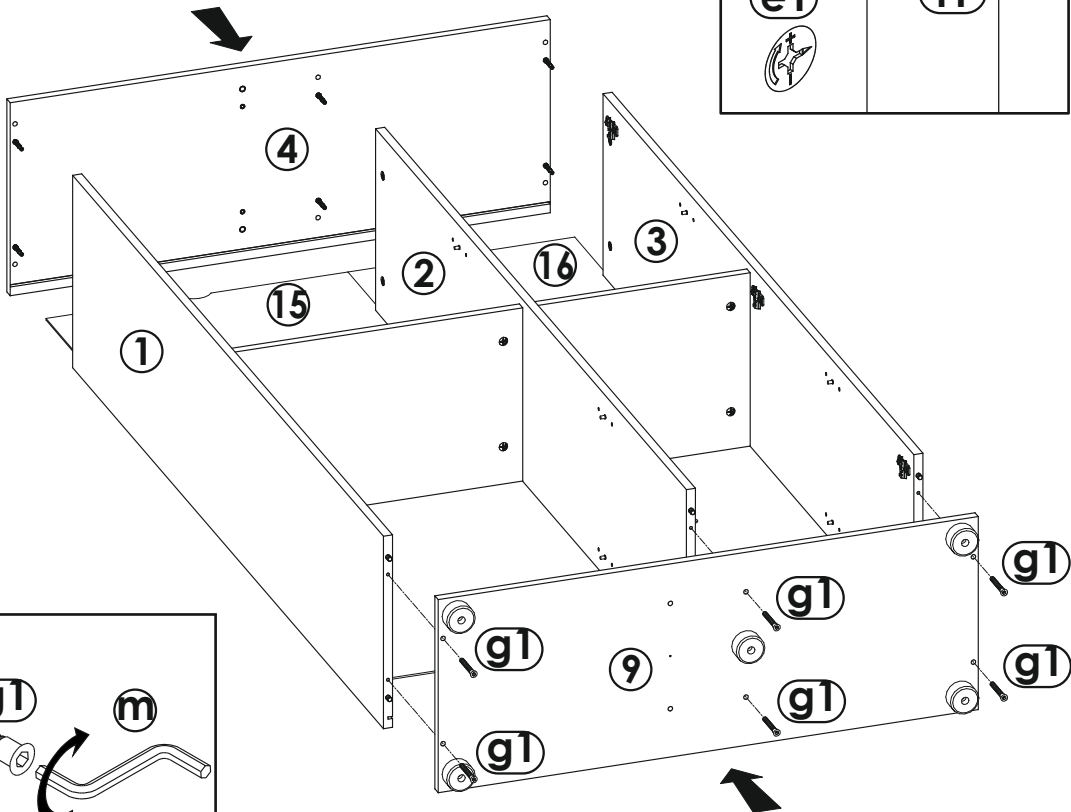
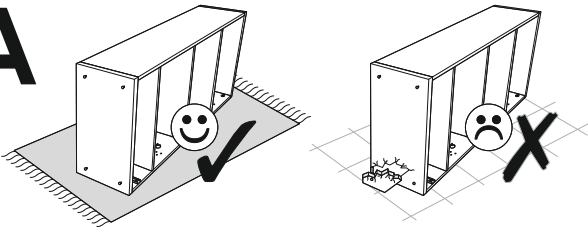

8A

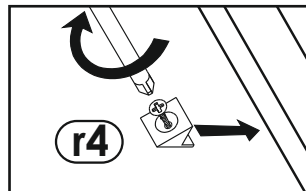
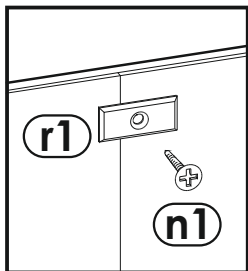
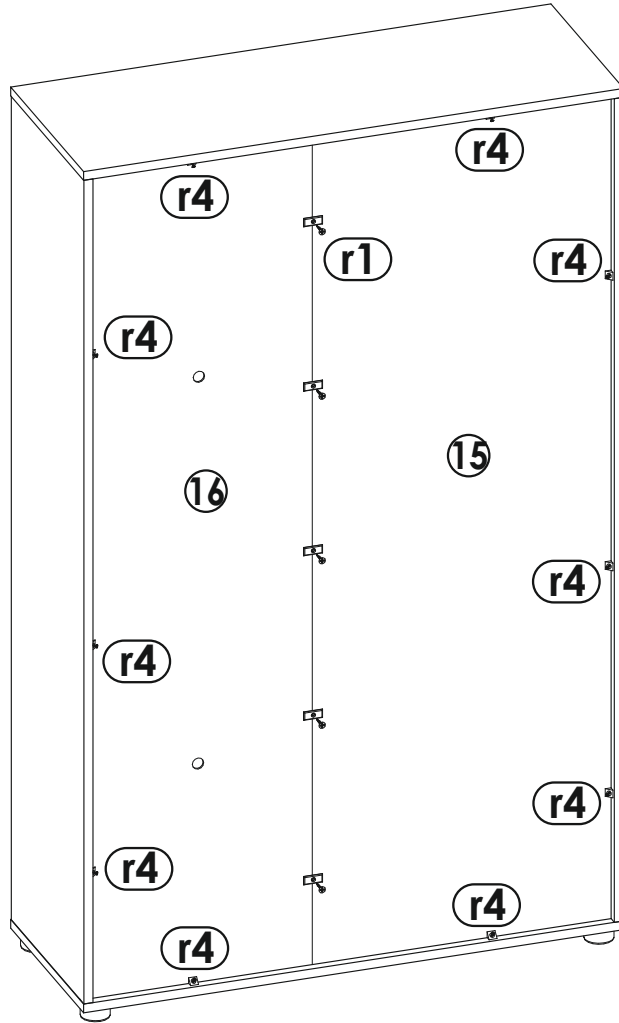
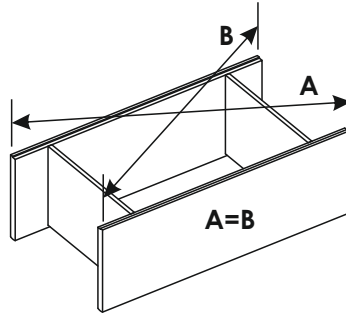
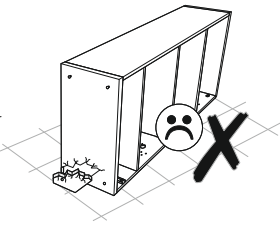
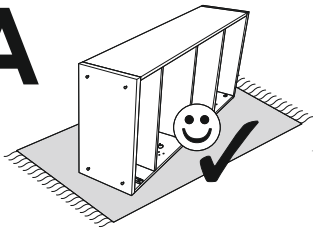

# 9A

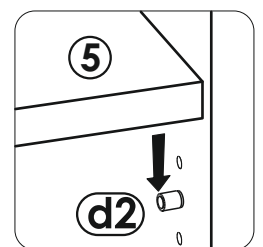
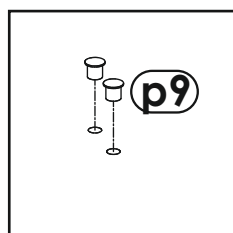
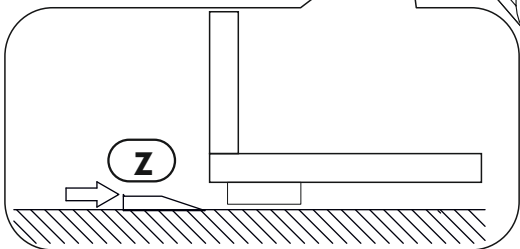
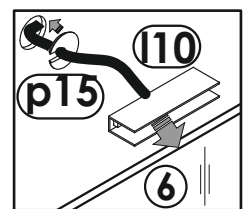
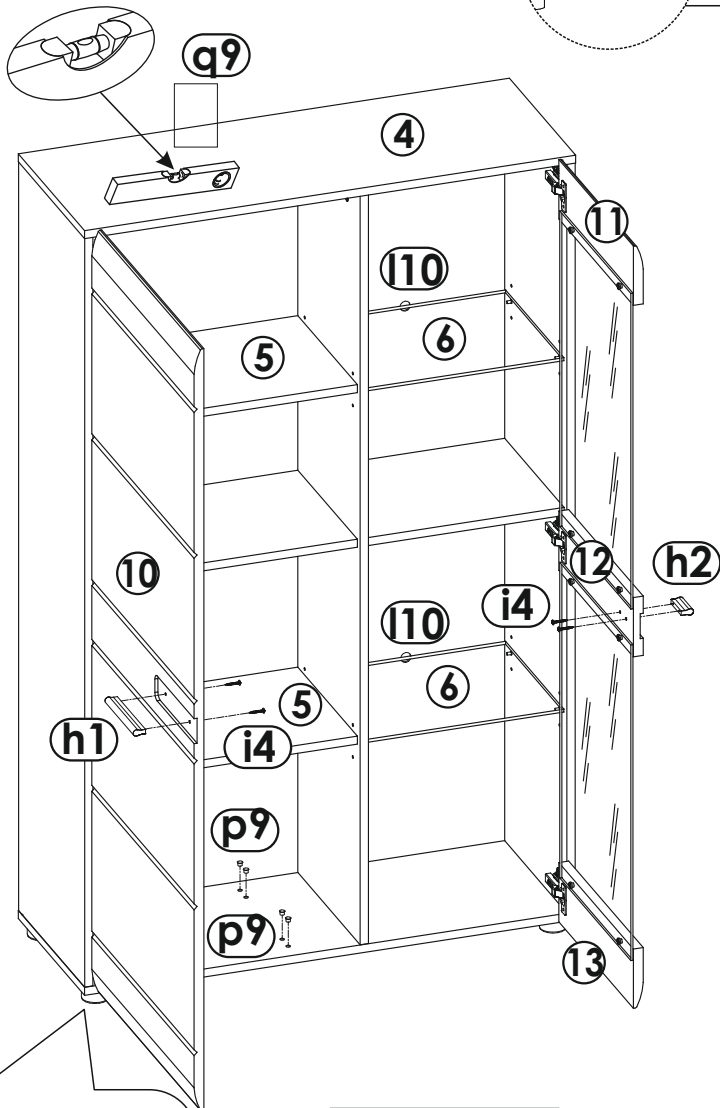
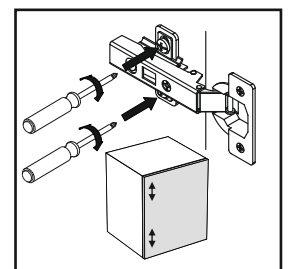
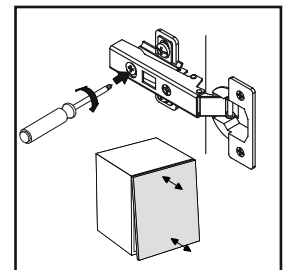
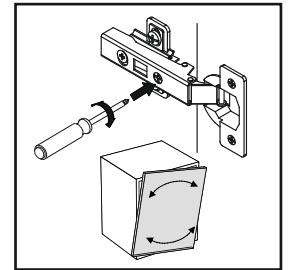
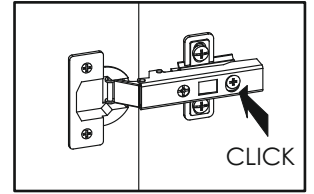
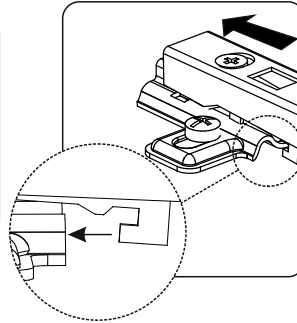
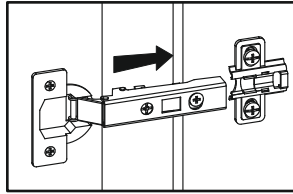
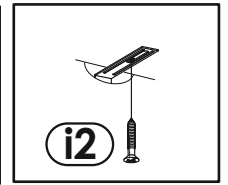
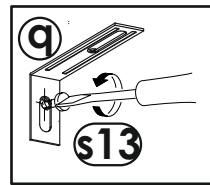
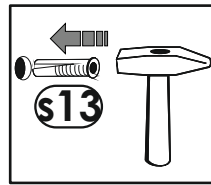
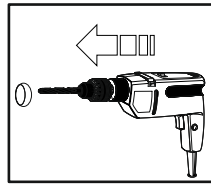
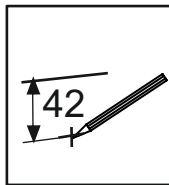
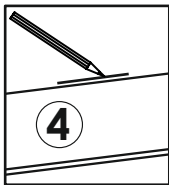



# AVENSIS NEW 03B

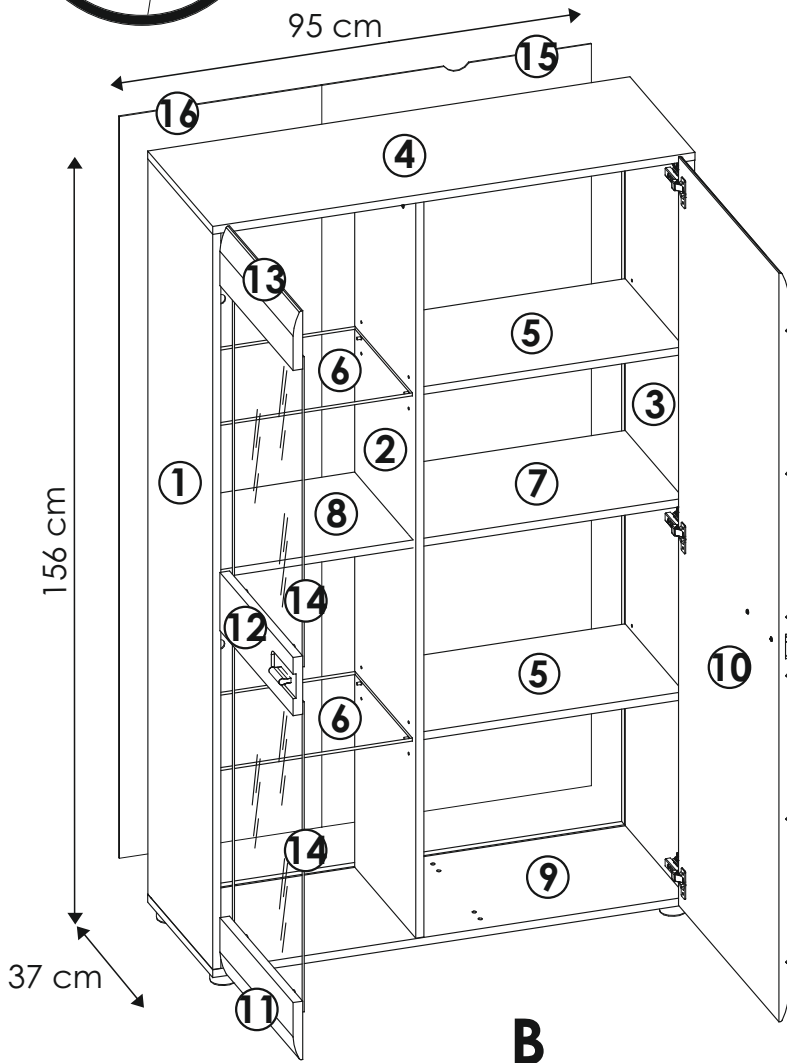

<b>a1</b> 8x35 x...(x16)	<b>a3</b> 8x60 x....(x2)	<b>bc0 + bo1</b> x....(x6)
<b>c1</b> Euro 4x13 x...(x12)	<b>d2</b> x...(x16)	<b>bc0</b> <b>bo1</b> x....(x6)
<b>e0</b> x...(x14)	<b>e1</b> x...(x14)	<b>et</b> Luca BESSONI x....(x1)
<b>f1</b> x...(x10)	<b>f3</b> 7x76 x....(x2)	
<b>g0</b> x....(x6)	<b>g1</b> 7x50 x....(x6)	<b>h2</b> x....(x1)
<b>h1</b> x....(x1)	<b>i2</b> 4x16 x....(x9)	<b>i4</b> 3,5x27 x....(x4)
<b>i10</b> 3,5x22 x....(x5)	<b>i10</b> x2 x....(x1)	<b>m</b> x....(x1)
<b>n1</b> 3x16 x....(x5)	<b>o15</b> x....(x5)	<b>p0</b> x....(x2)
	<b>p9</b> ø8 x....(x6)	<b>p15</b> x....(x2)
<b>q9</b> x....(x1)	<b>s13</b> x....(x1)	<b>r1</b> x....(x5)
		<b>r3</b> x....(x8)
<b>r4</b> x....(x10)	<b>z</b> x....(x1)	

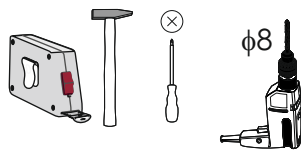
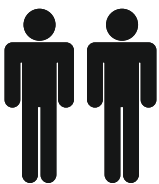

1B  
▼

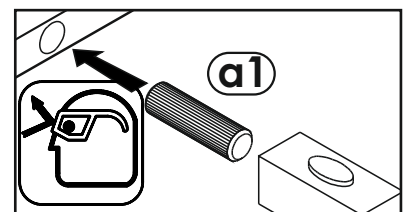
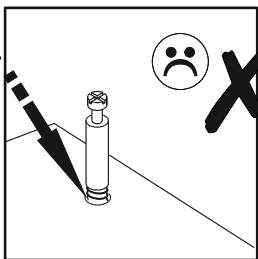
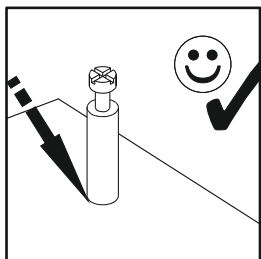
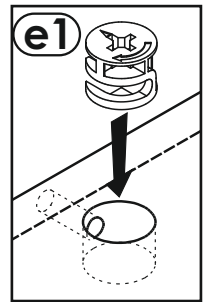
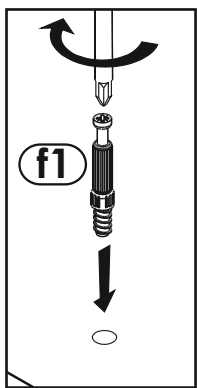
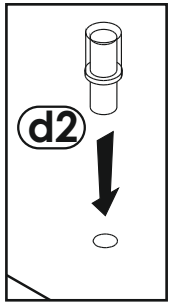
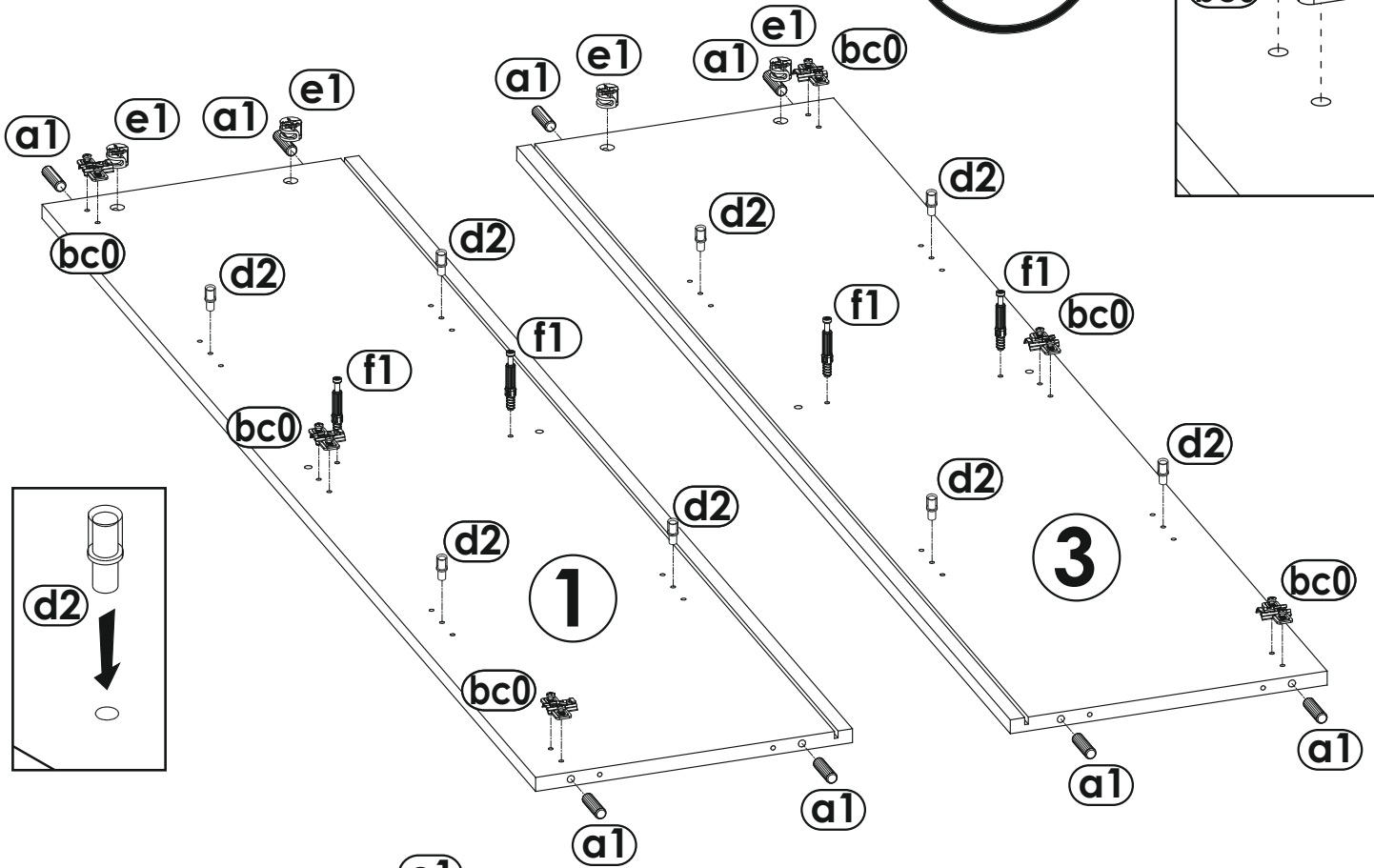
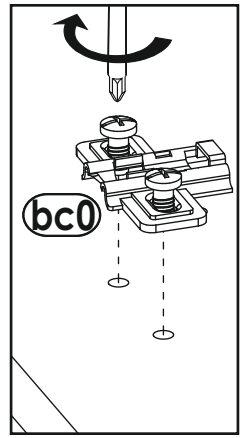
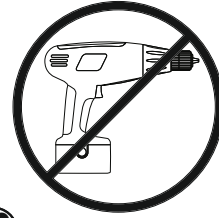
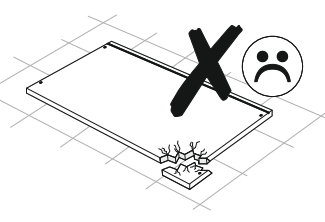
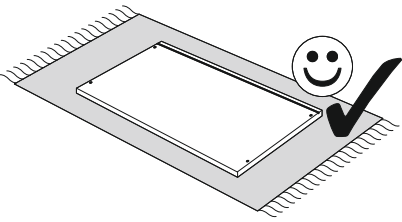

# 2B

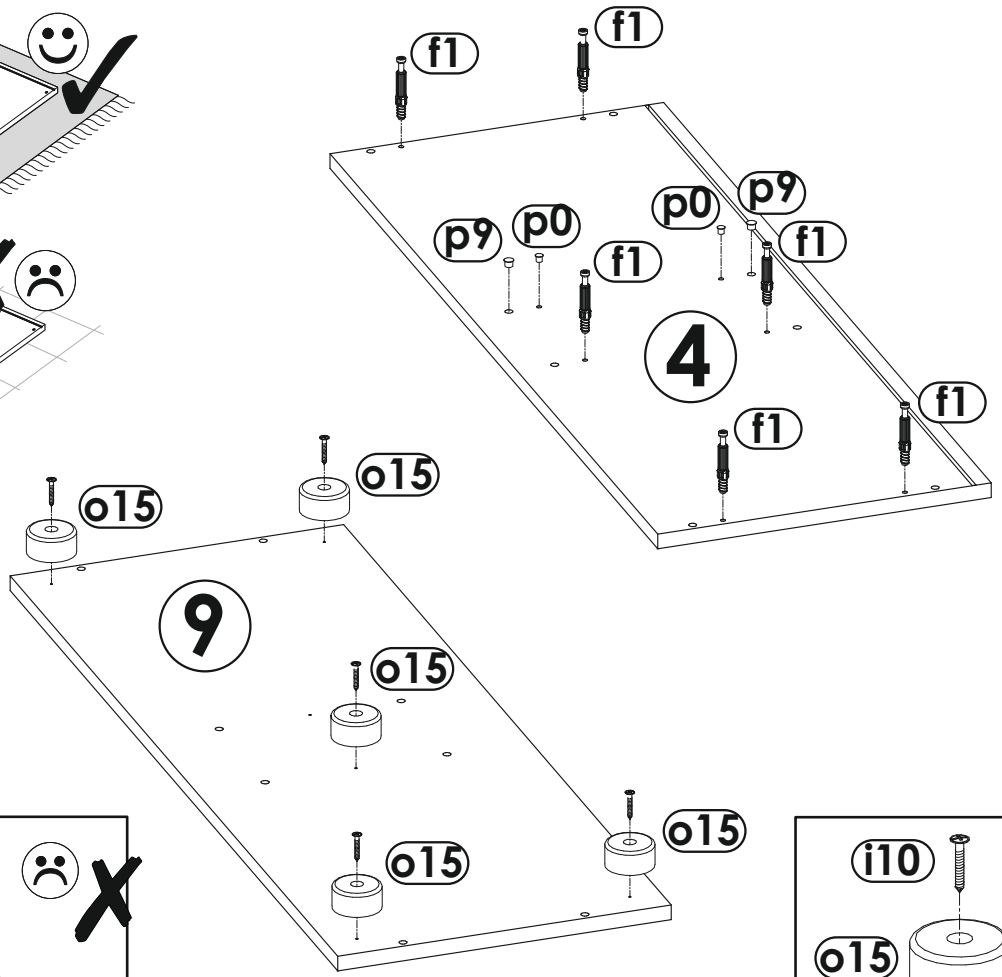
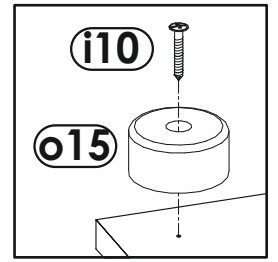
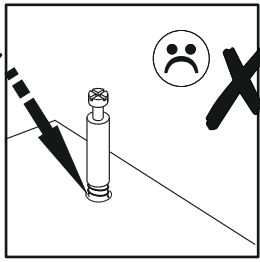
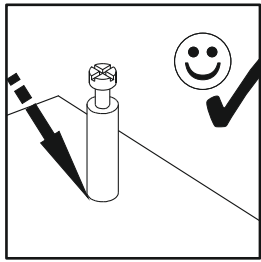
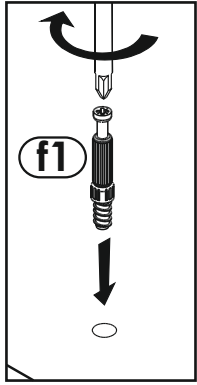
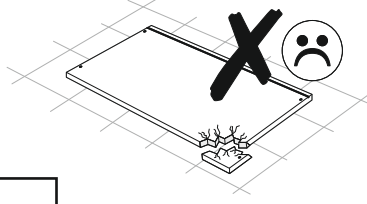
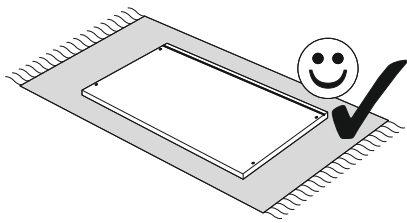

# 3B

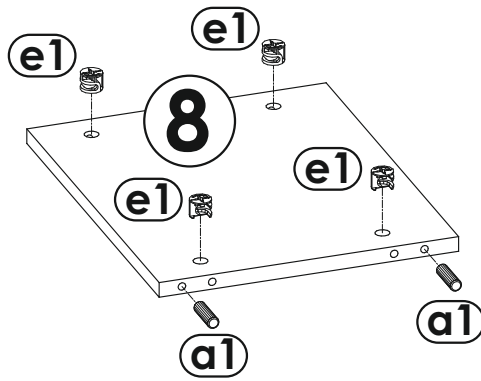
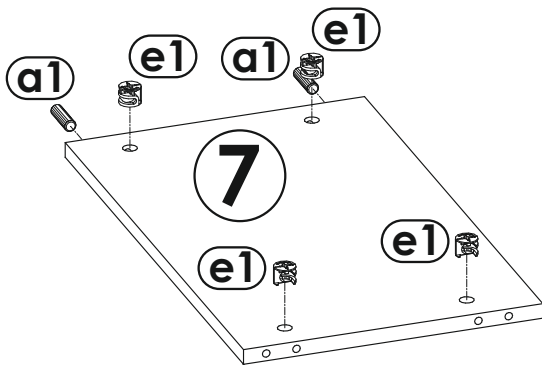
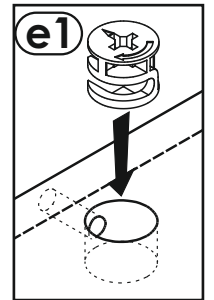
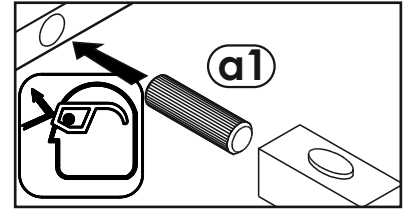
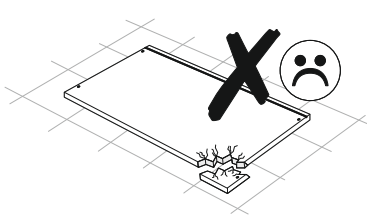
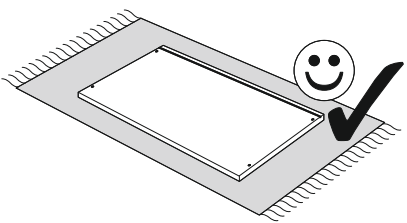

# 4B

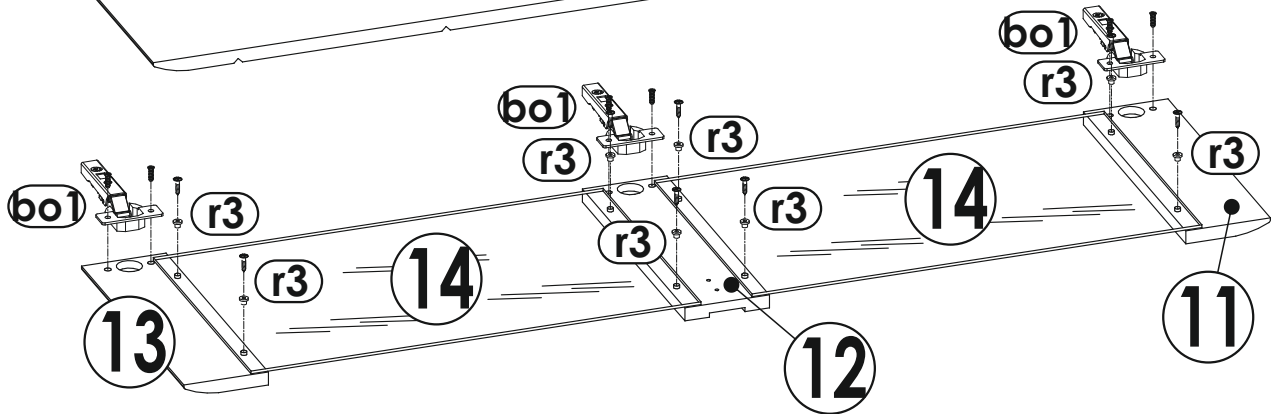
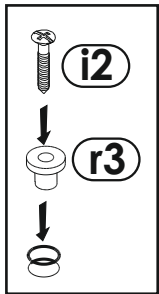
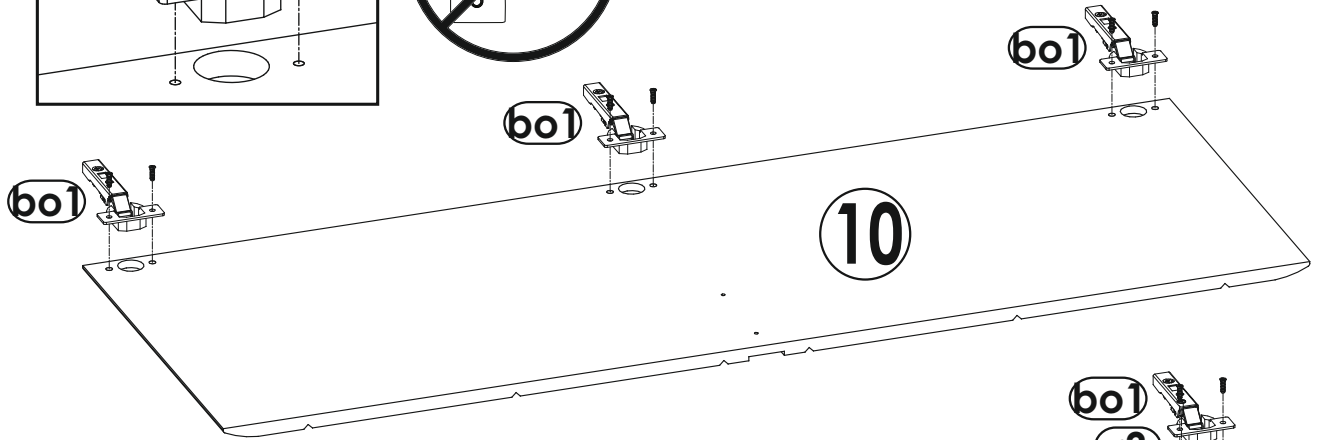
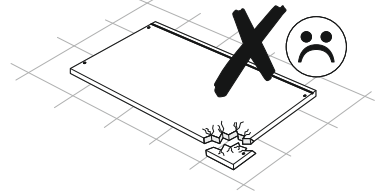
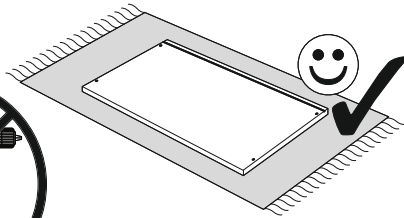
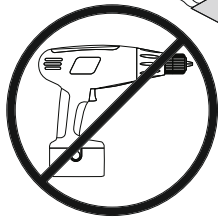
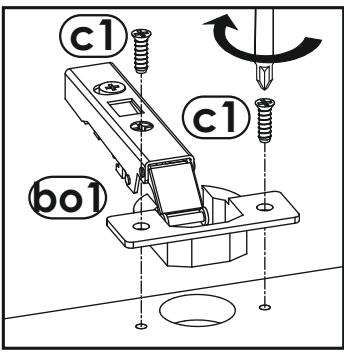

# 5B

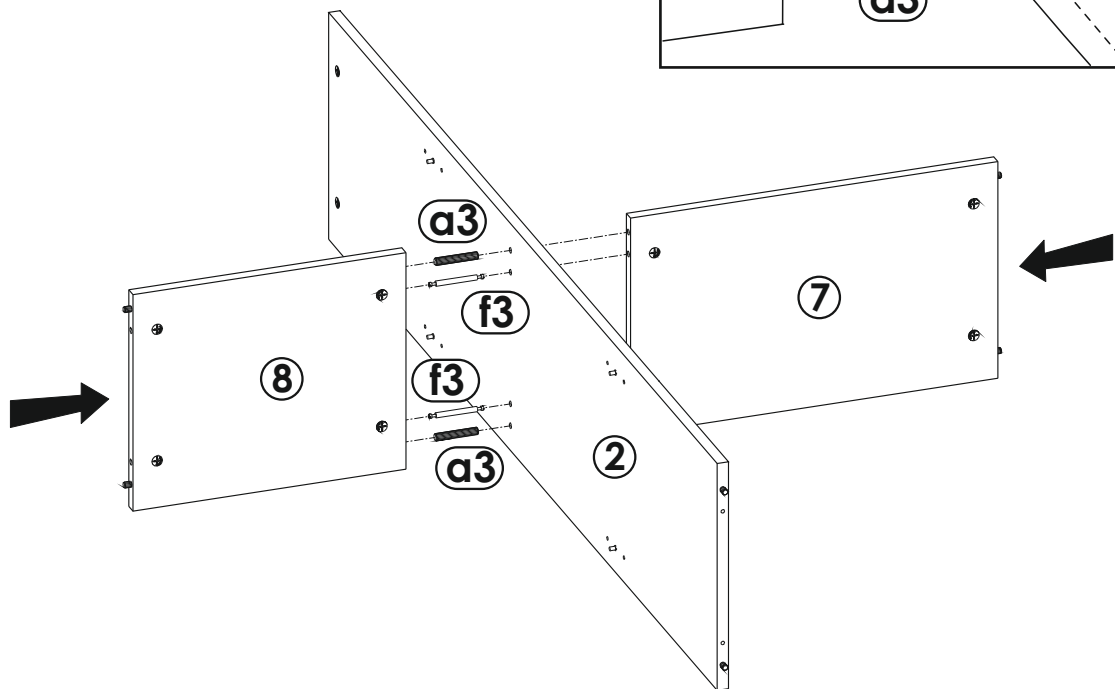
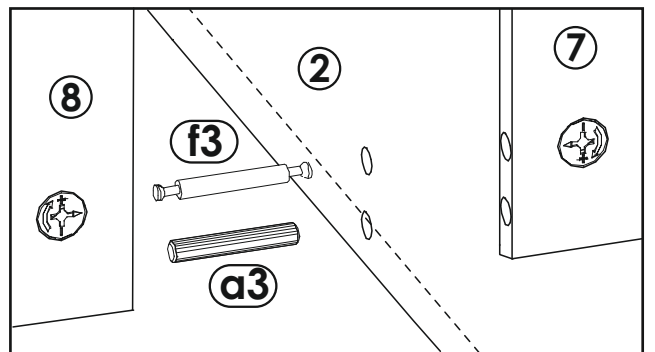
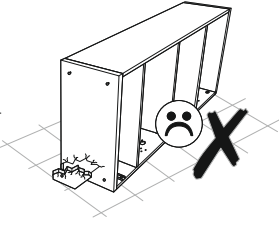
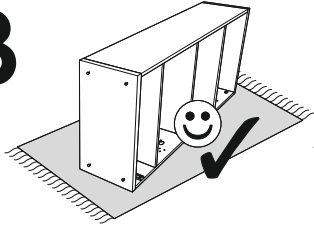

# 6B

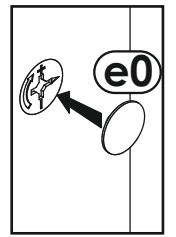
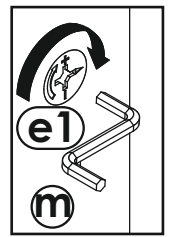
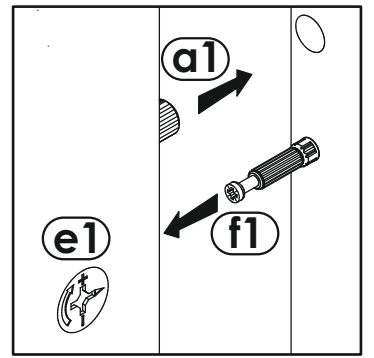
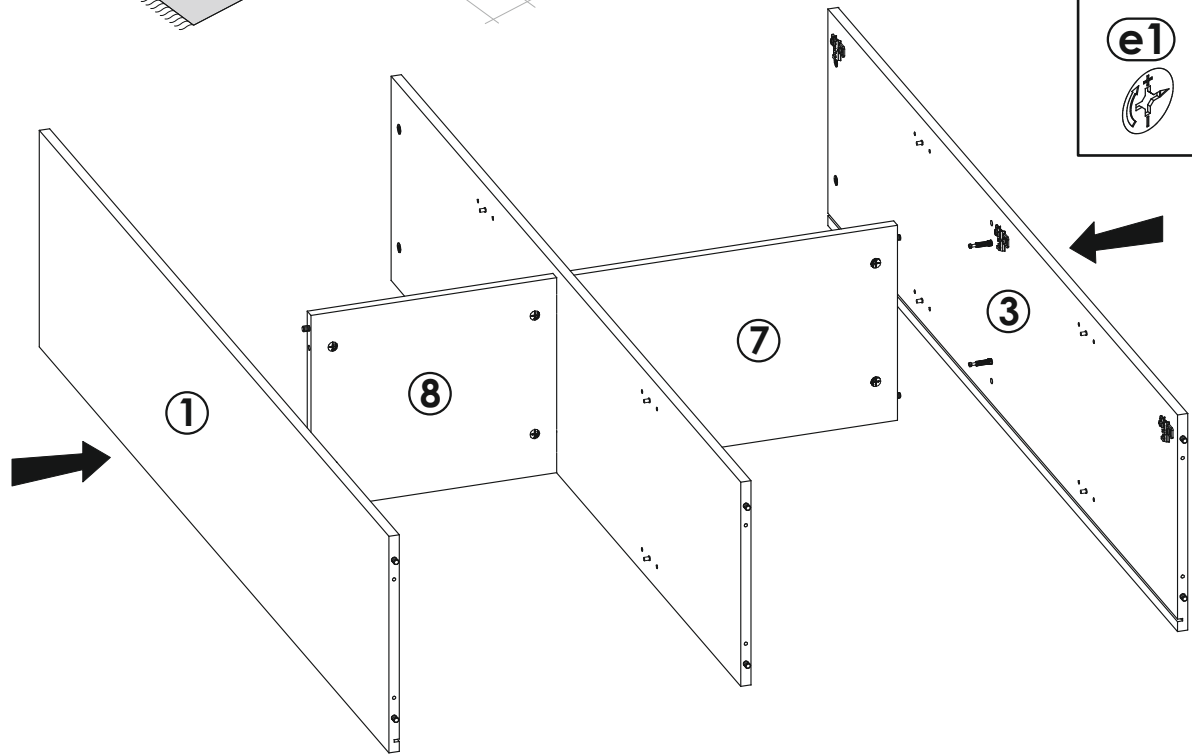
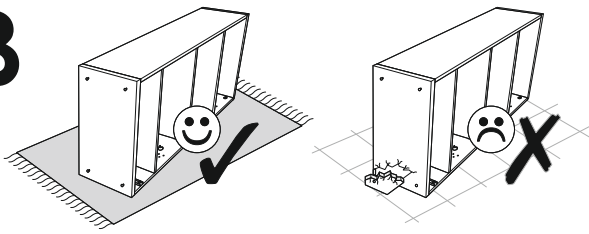

# 7B

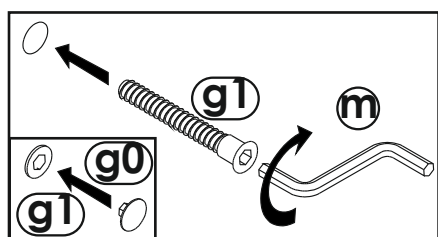
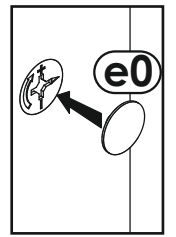
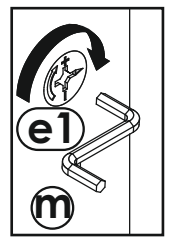
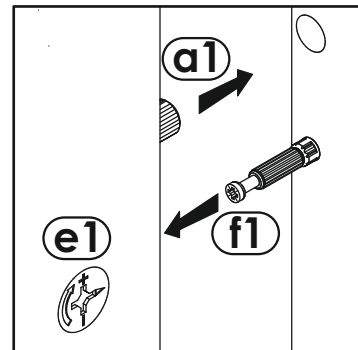
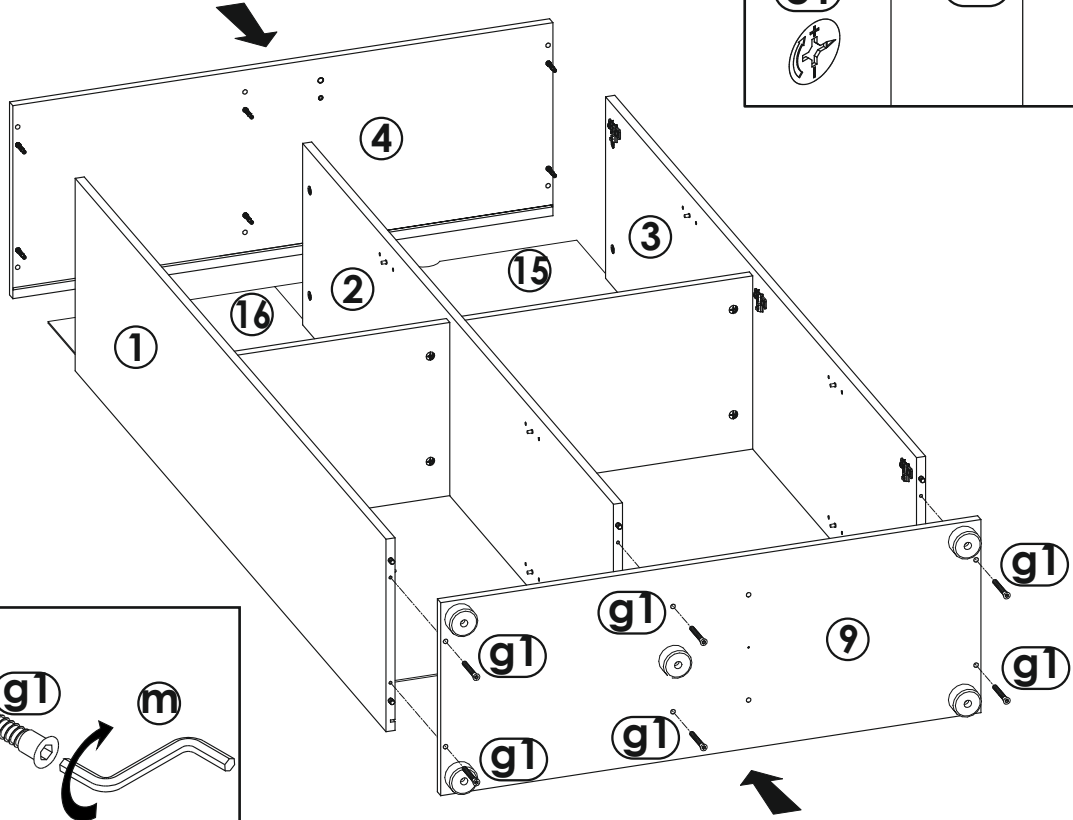
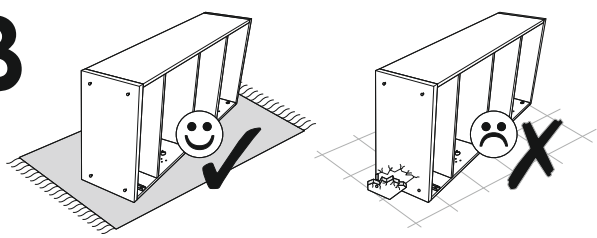

**8B**  
▼

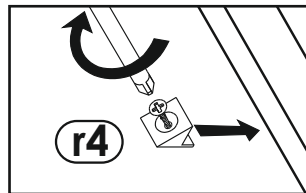
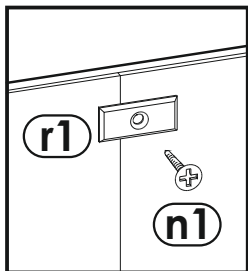
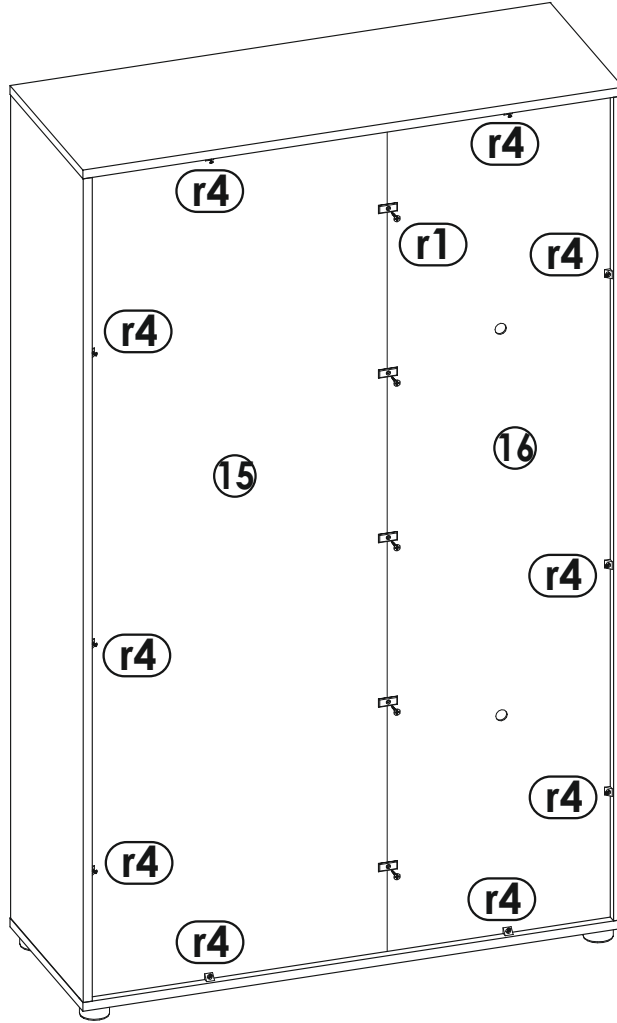
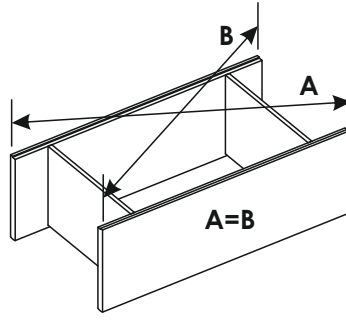
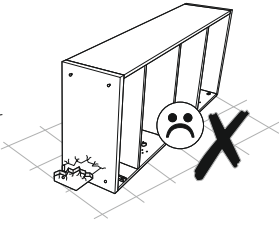
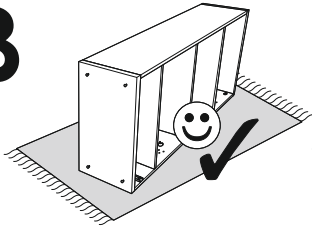

# 9B

