

AVENSIS NEW 104

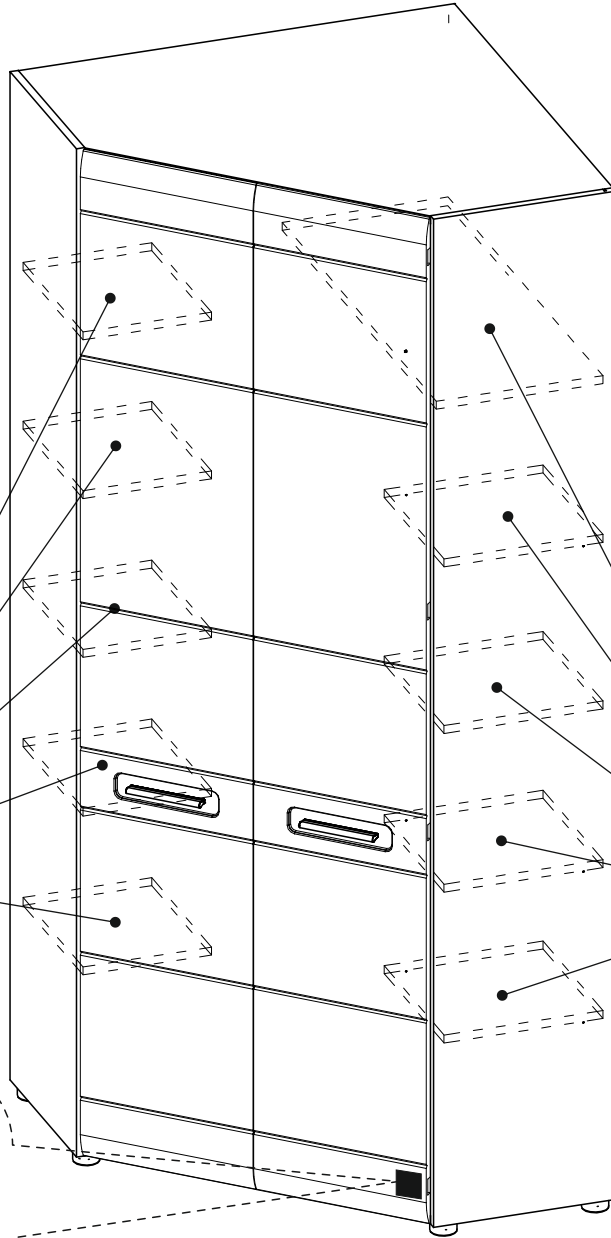

max.
3 kg

max.
5 kg

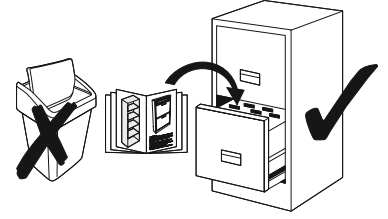
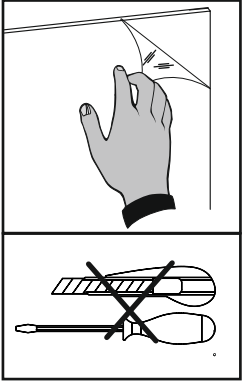

① - C3 ③ - C1 ⑤ - C2 ⑦ - C1,C2 ⑨ - C3 ⑪ - C2 ⑬ - C3

② - C3 ④ - C1 ⑥ - C1 ⑧ - C1 ⑩ - C3 ⑫ - C2

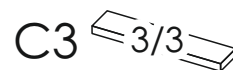

AVENSIS NEW 104

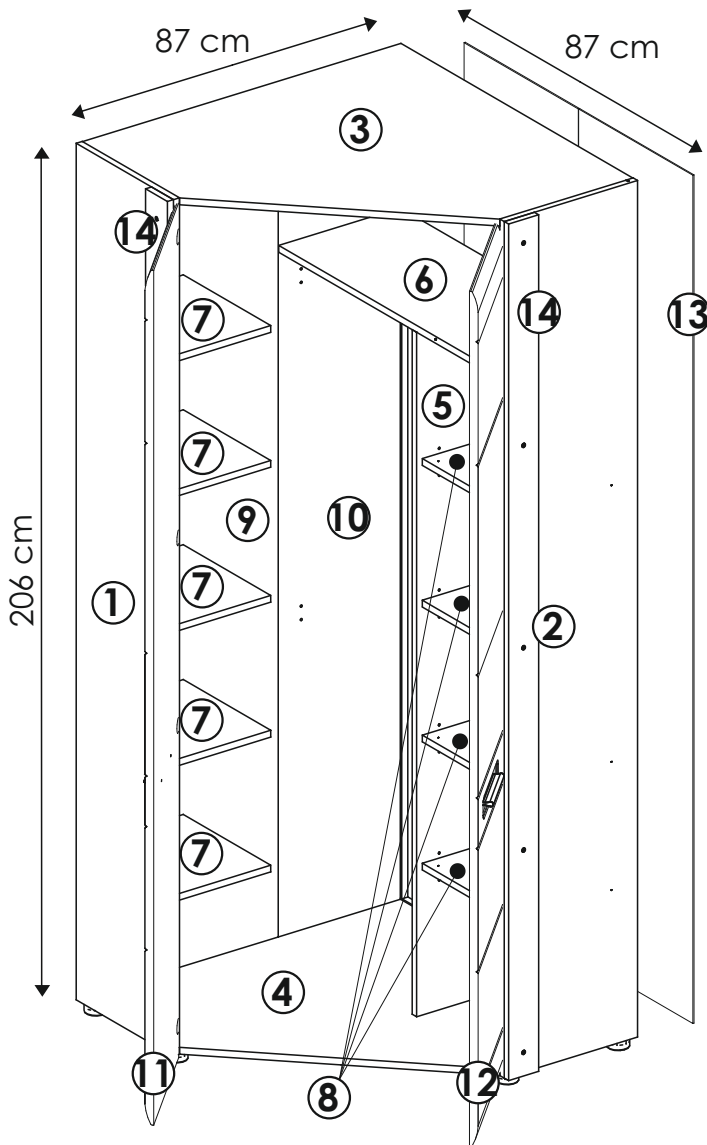

a1 8x35 x...(x49)	bc5 + bc0 x...(x8)		
a2 8x45 x...(x4)	bc5	bc0	
c1 Euro 4x13 x...(x16)	d2 x...(x16)	e0 x...(x27)	e1 x...(x27)
et LUCA BESSONI x...(x1)	f1 x...(x27)	g1 7x50 x...(x16)	
g0 x...(x16)	h1 x...(x2)		
i2 4x16 x...(x2)	i4 3.5x27 x...(x4)	i7 4x25 x...(x10)	i10 3.5x22 x...(x8)
p12 x...(x4)	q x...(x2)	r4 x...(x14)	s13 x...(x2)
w0 L-478 x...(x2)	z x...(x1)		
m x...(x1)	n1 3x16 x...(x10)	o15 x...(x8)	

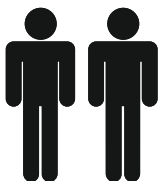

1

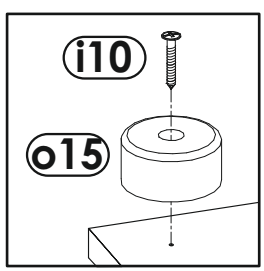
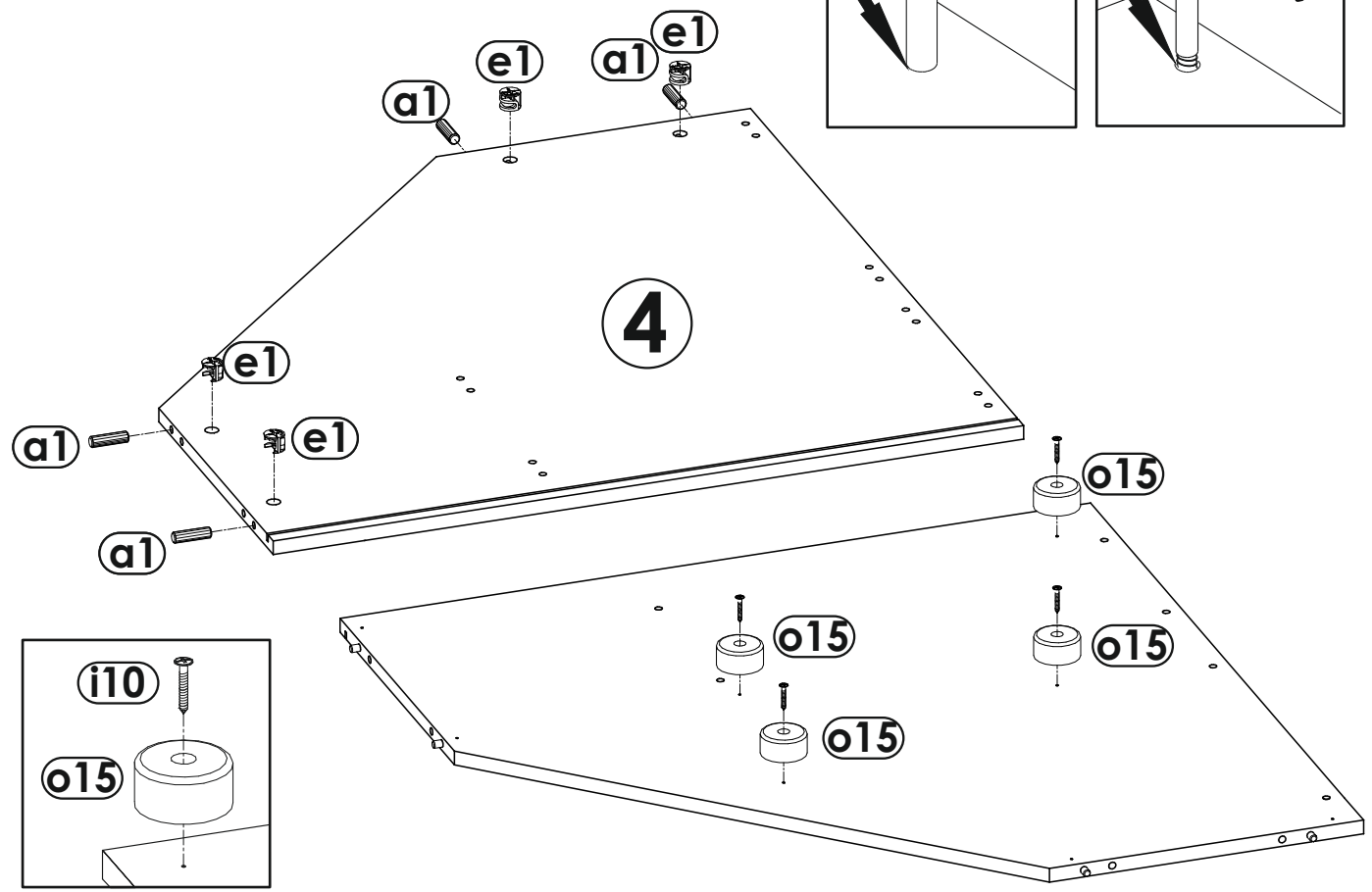
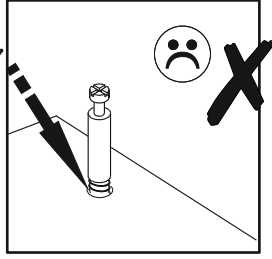
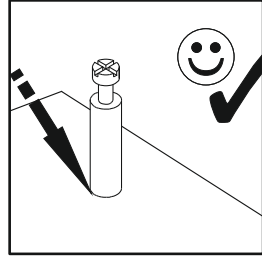
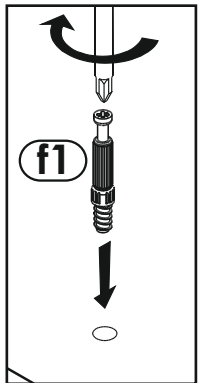
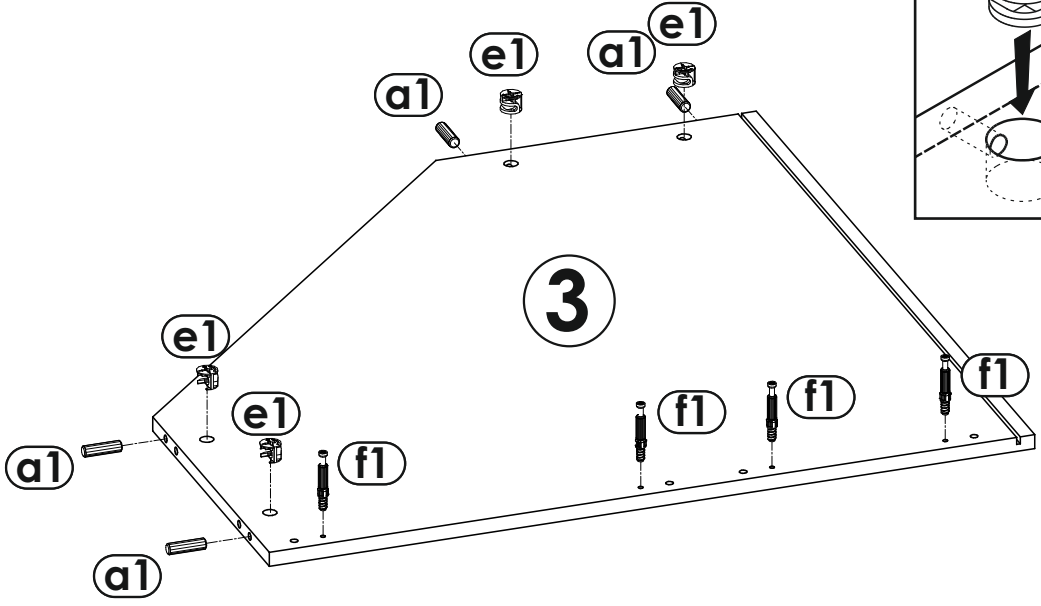
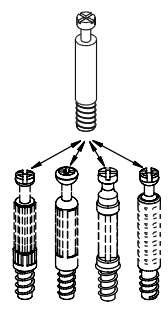
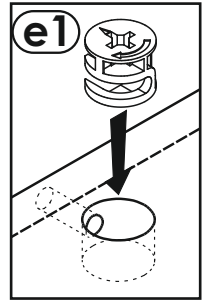
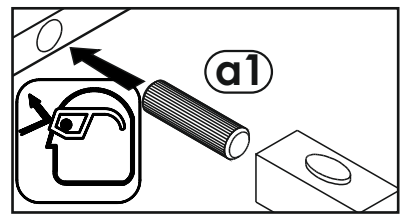
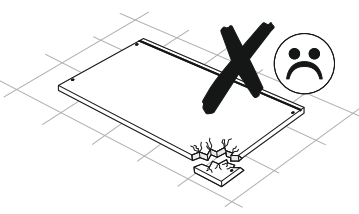
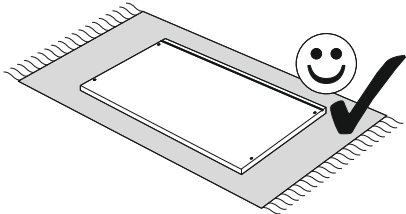

2

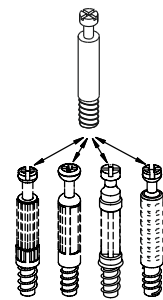
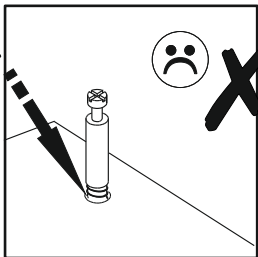
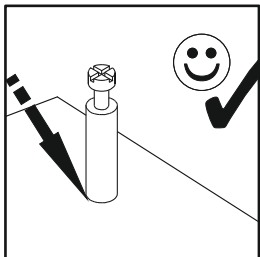
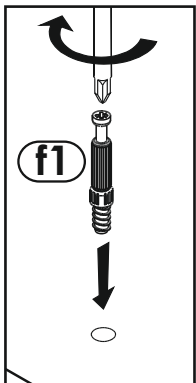
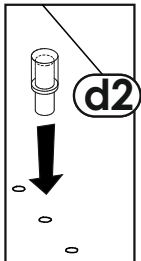
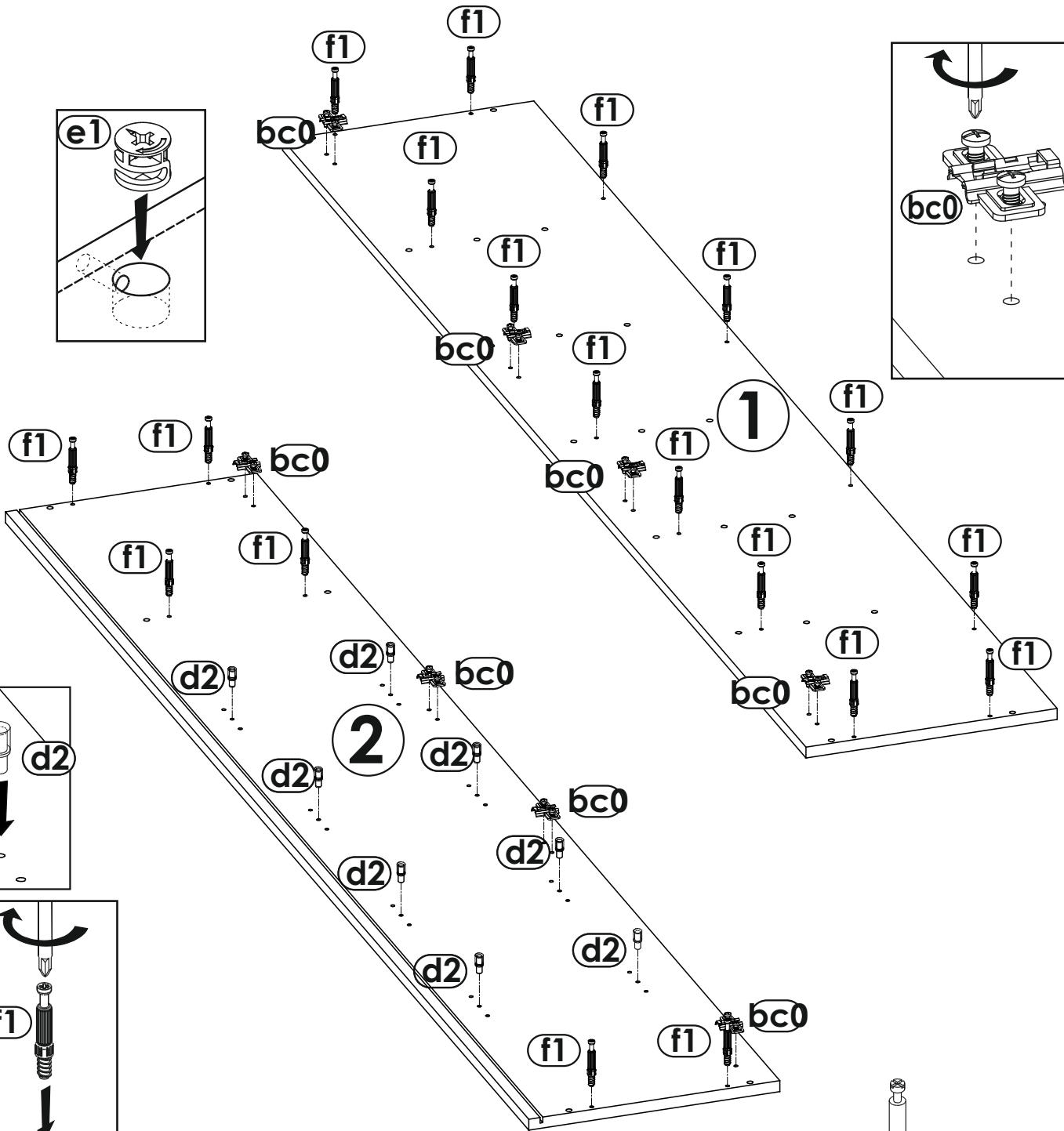
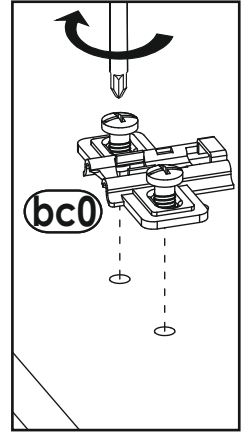
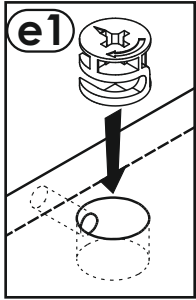
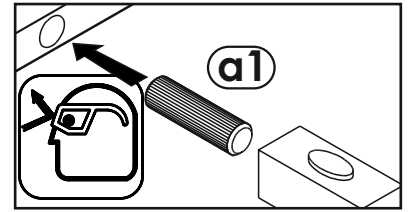
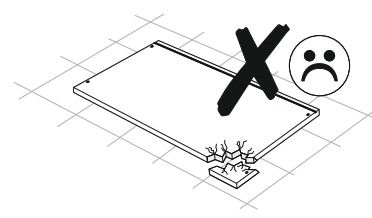
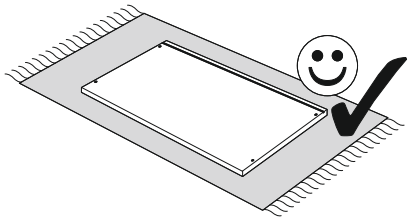

3

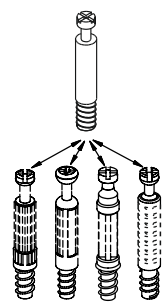
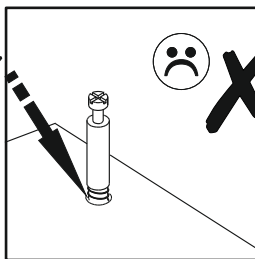
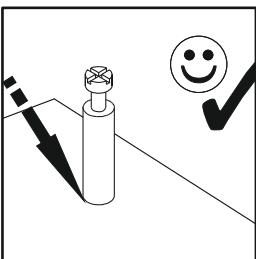
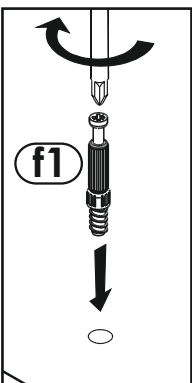
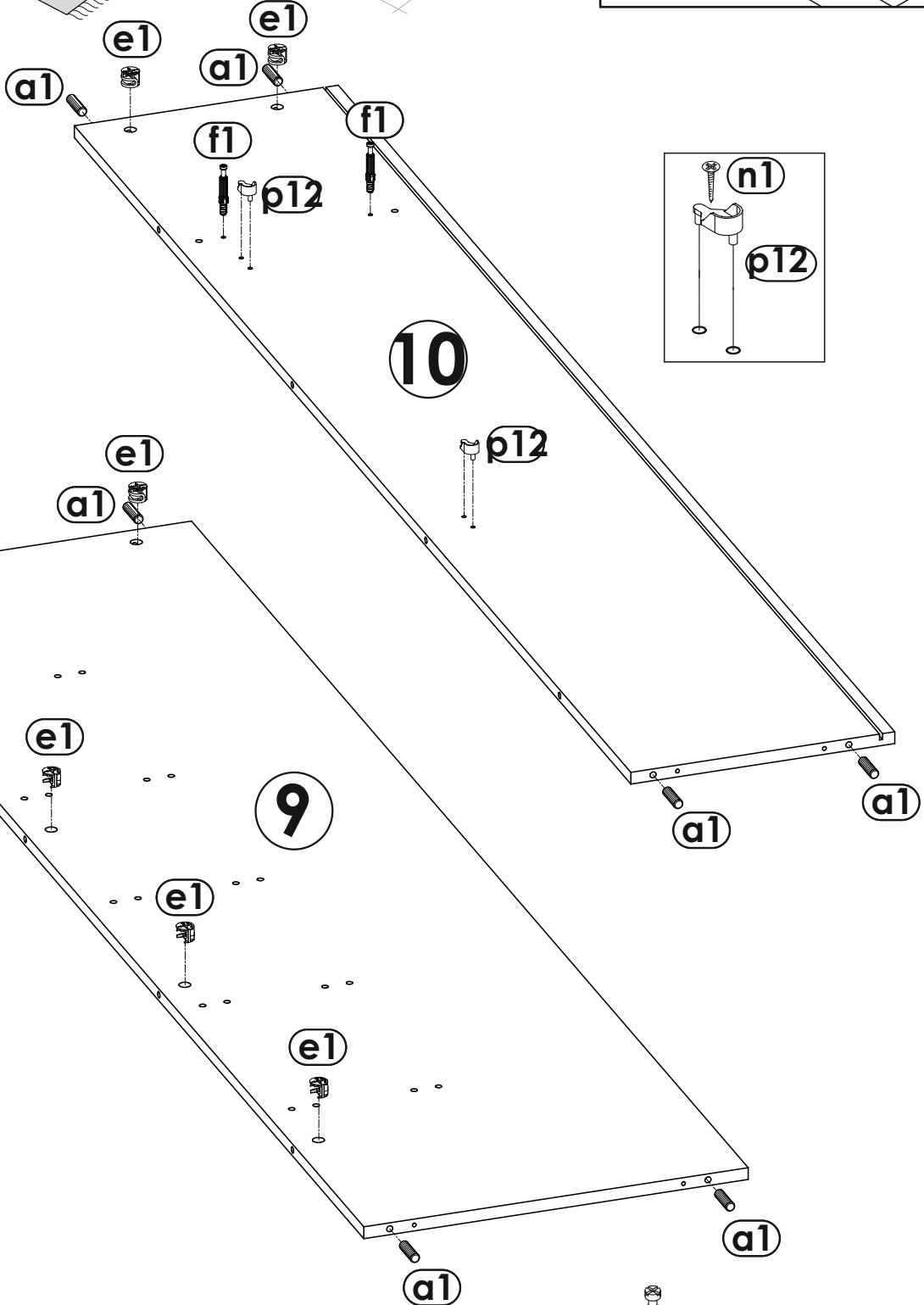
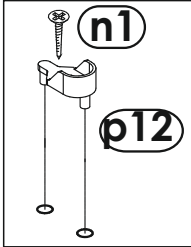
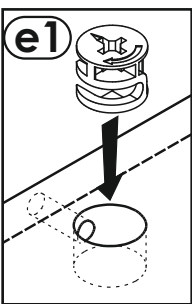
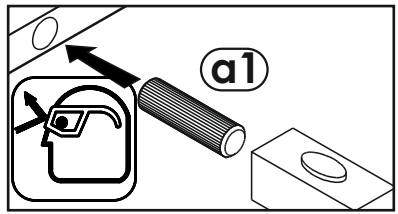
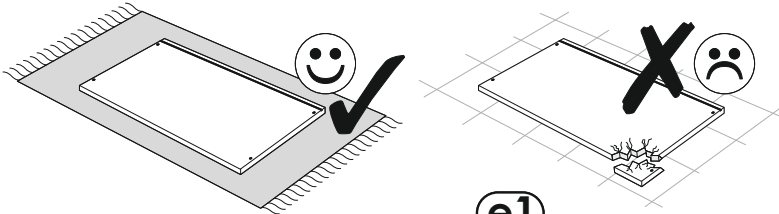

4

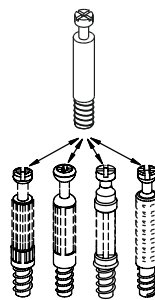
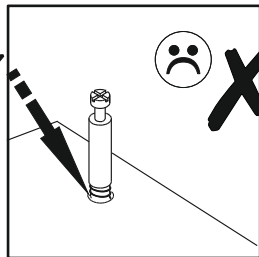
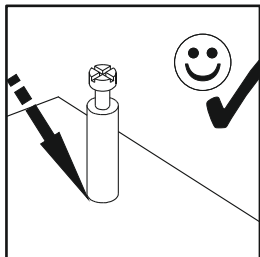
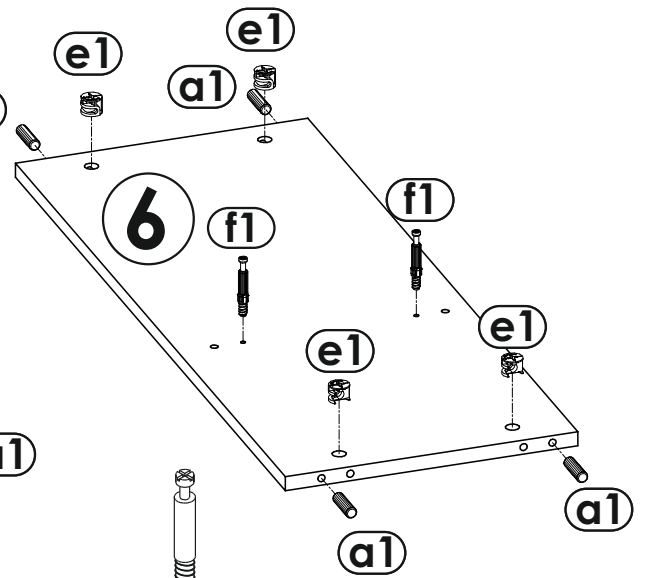
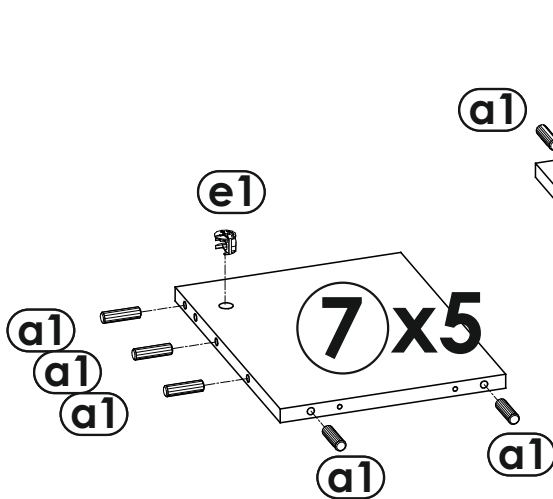
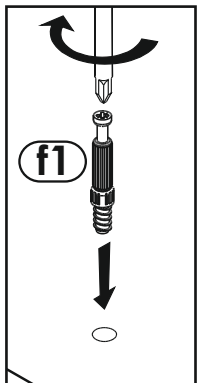
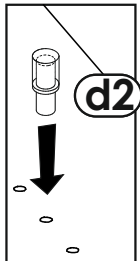
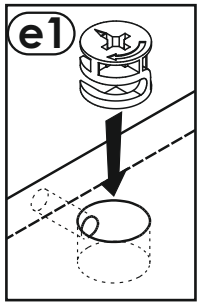
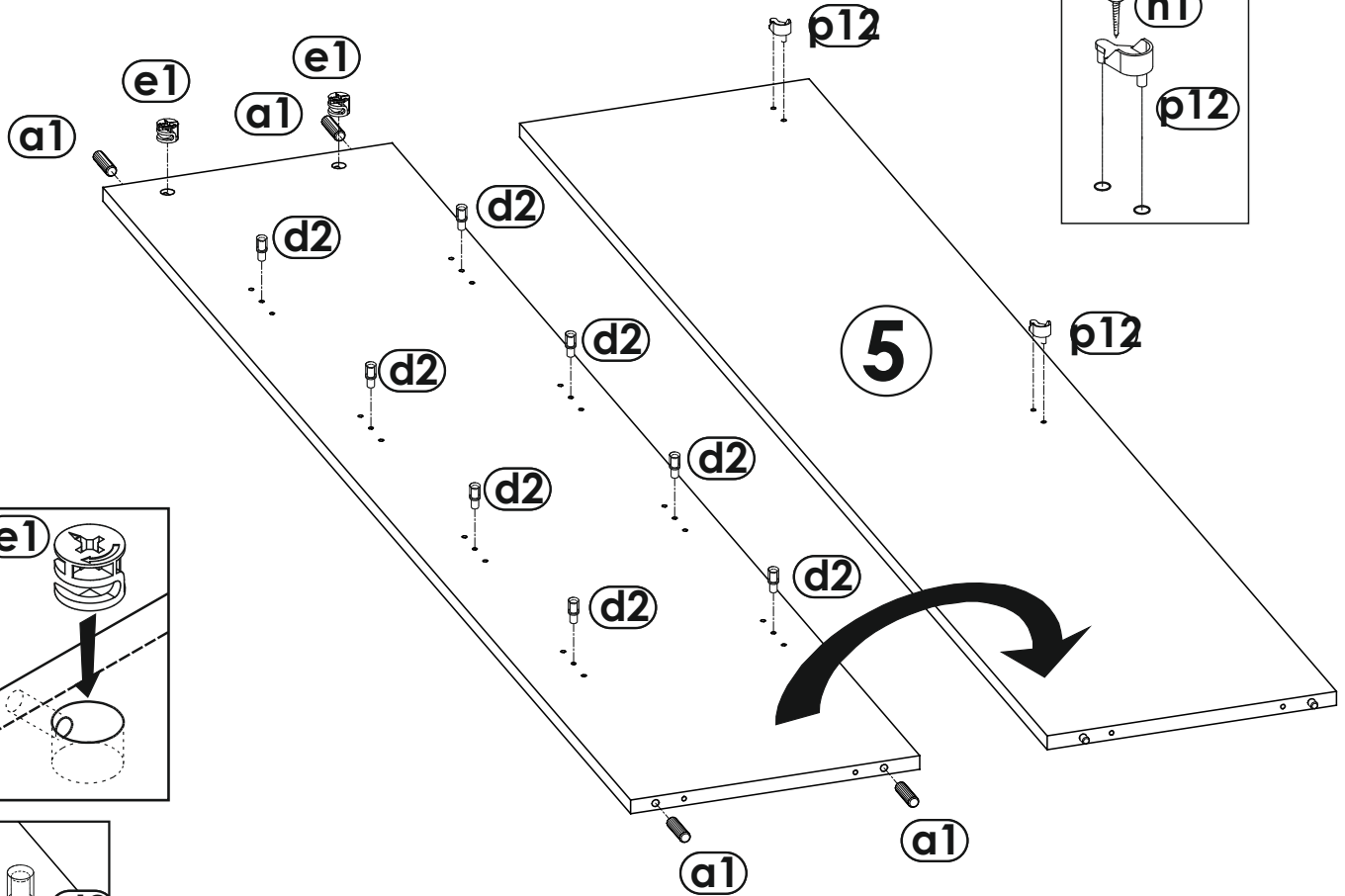
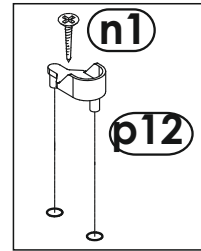
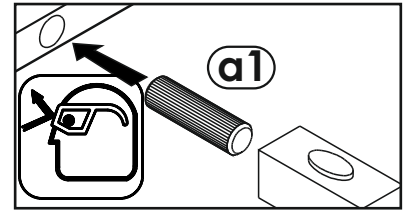
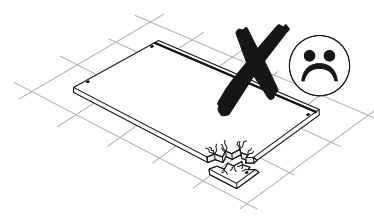
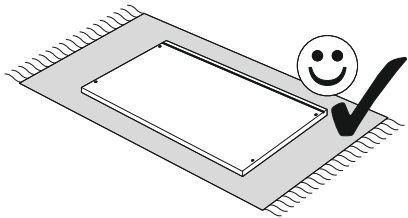

5

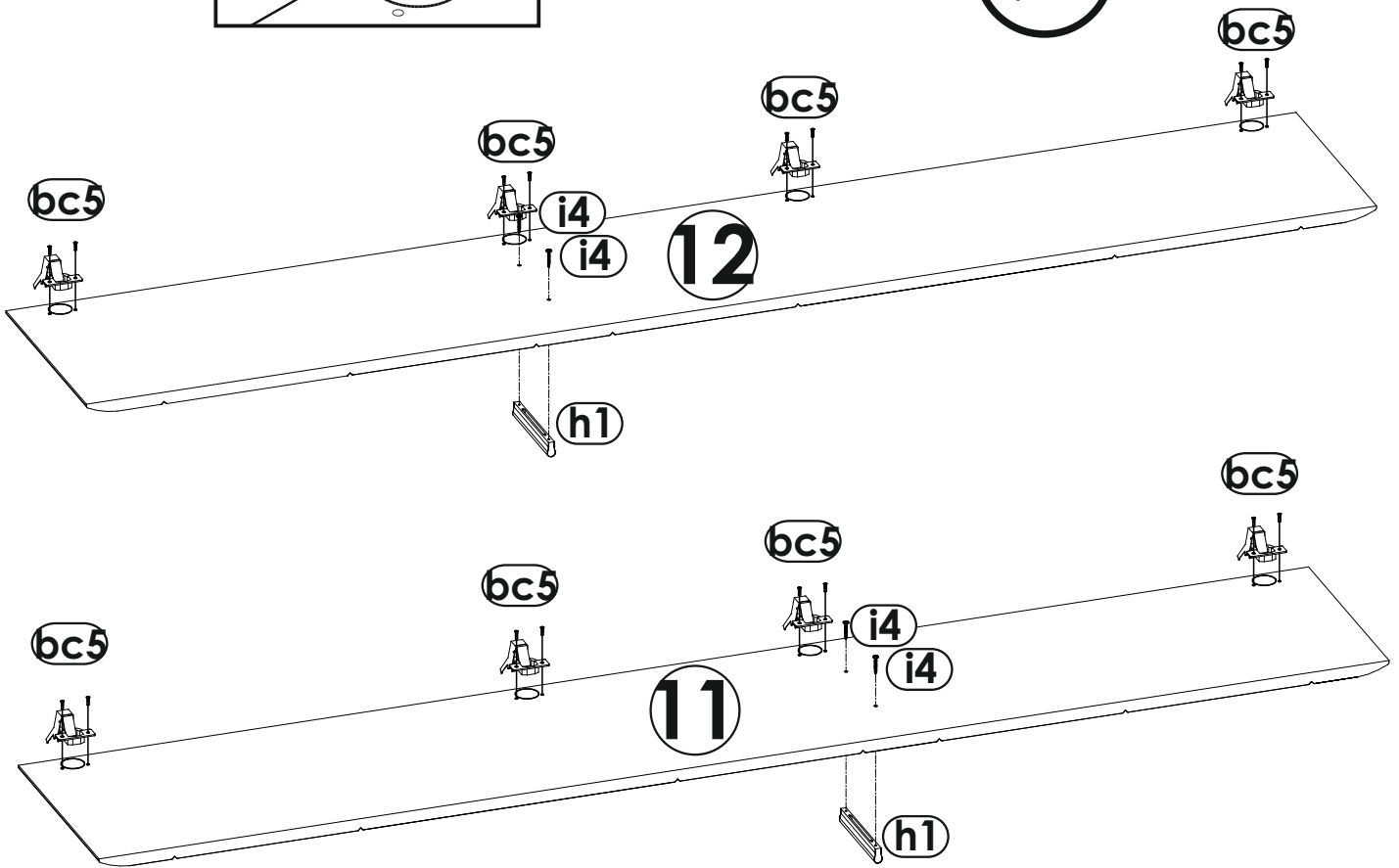
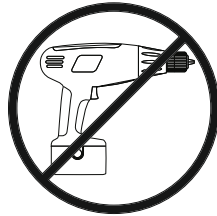
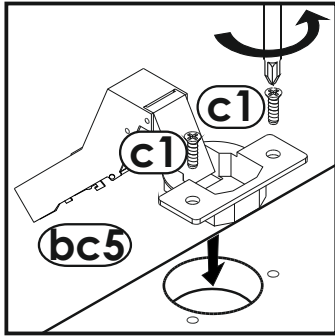
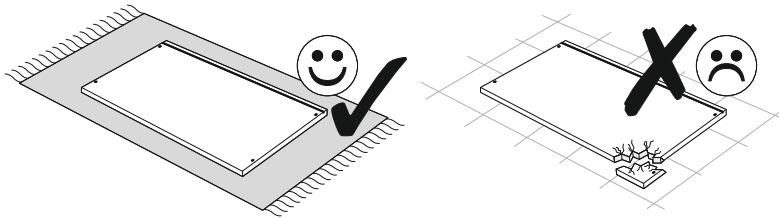

6

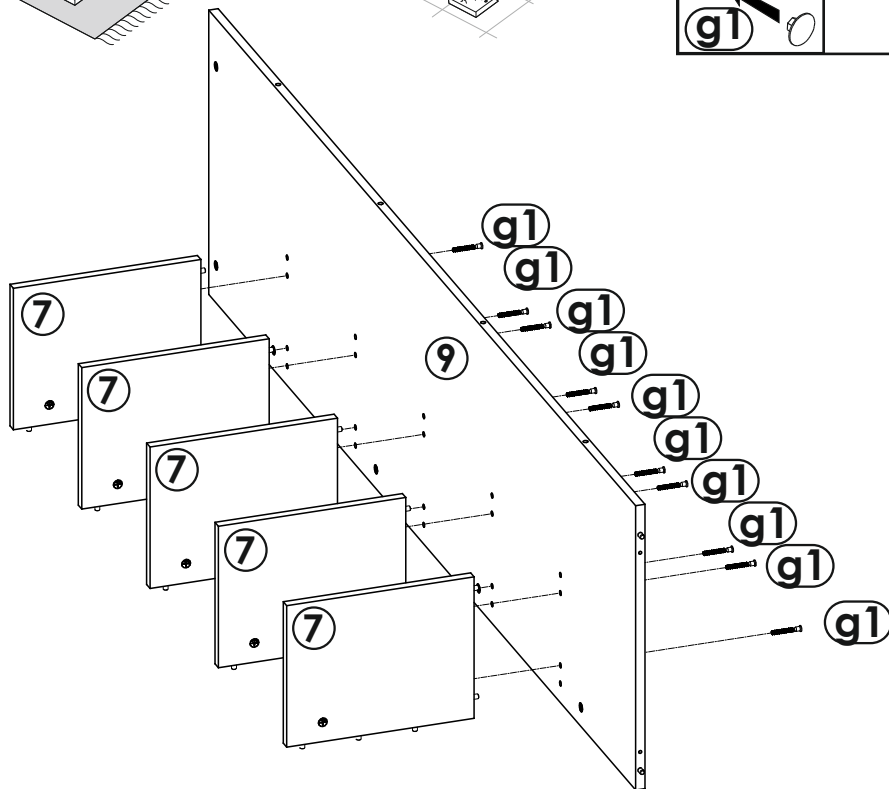
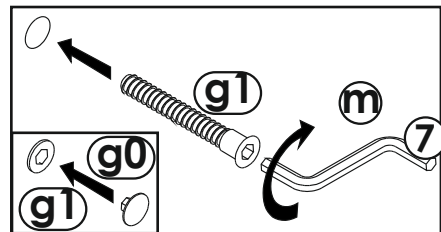
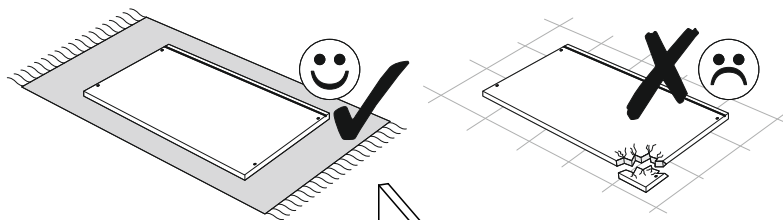

7

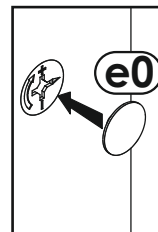
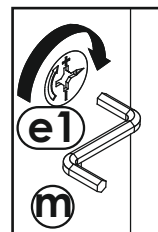
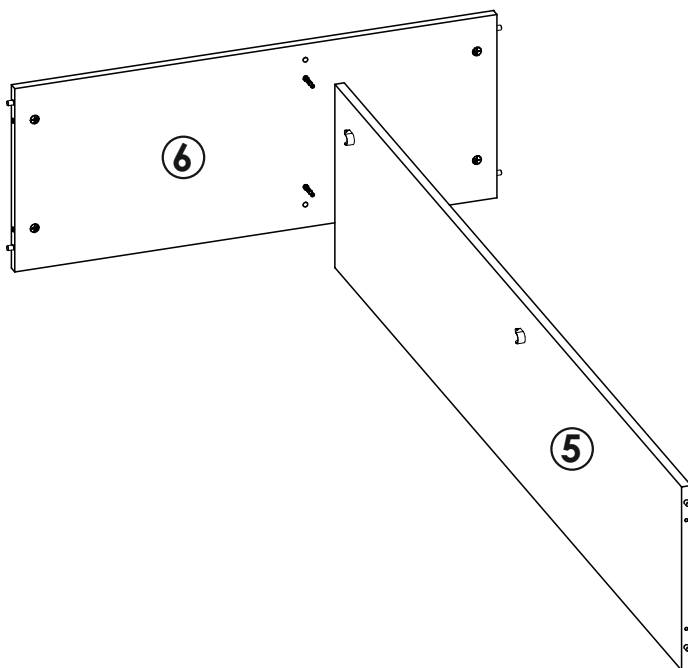
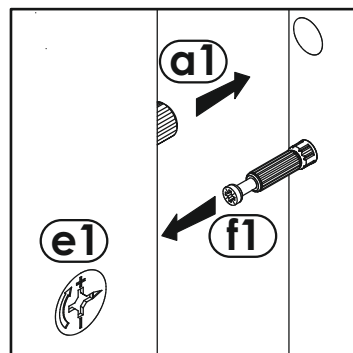
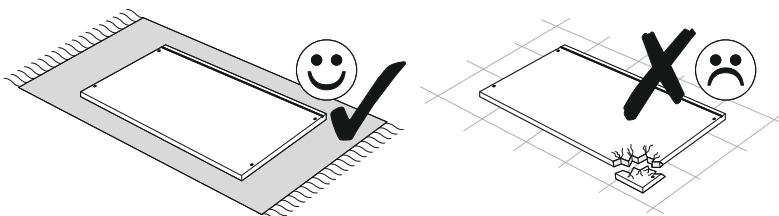

8

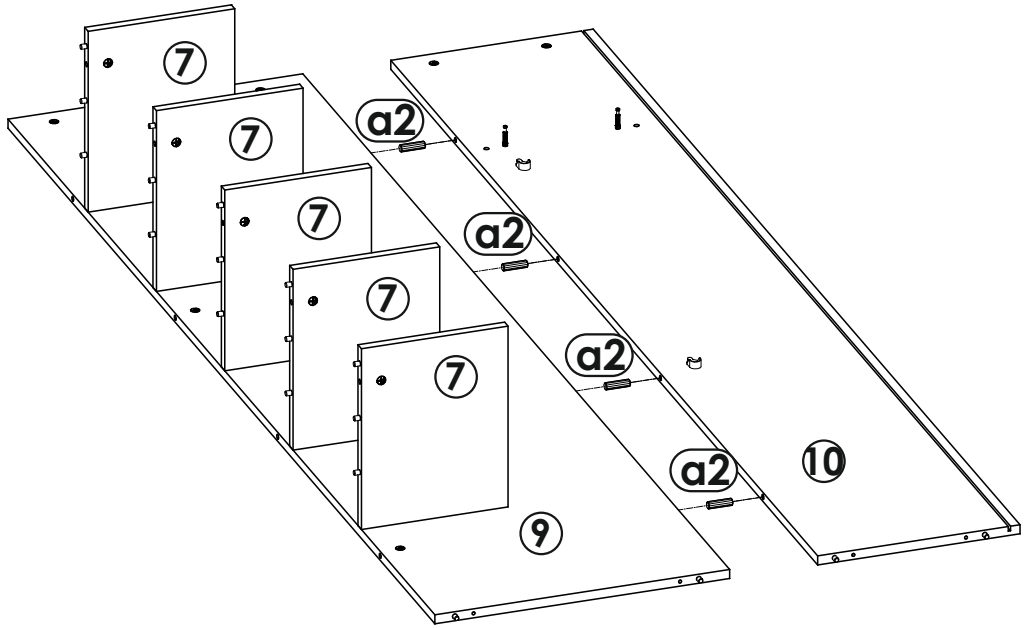
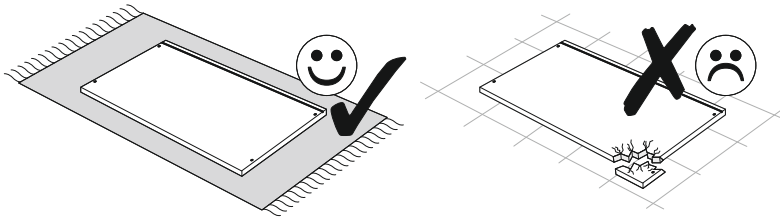

9

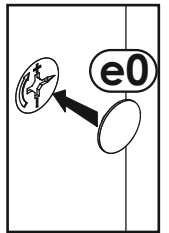
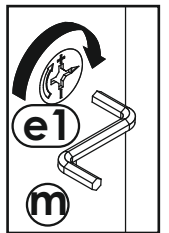
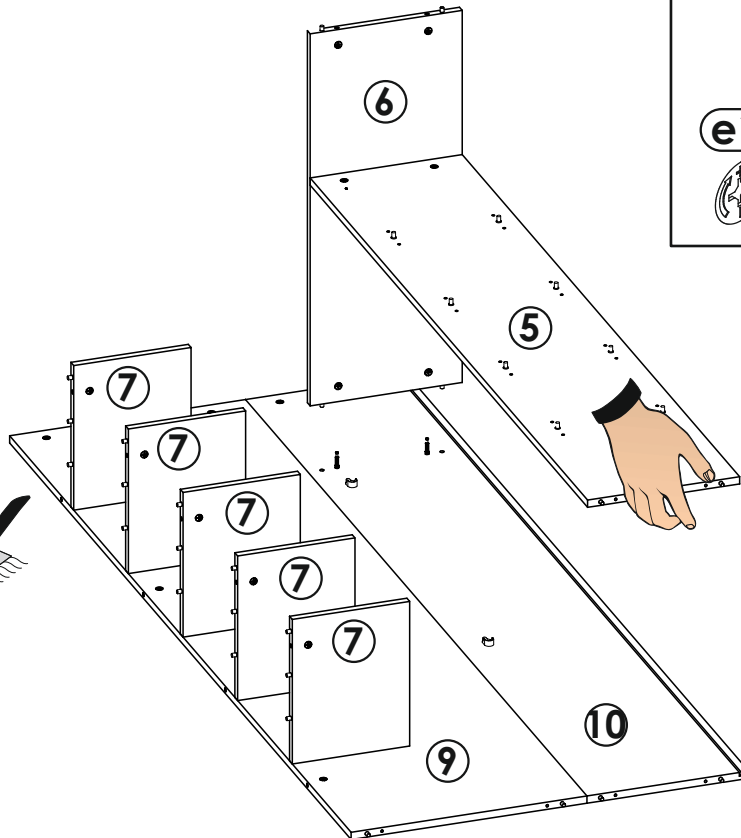
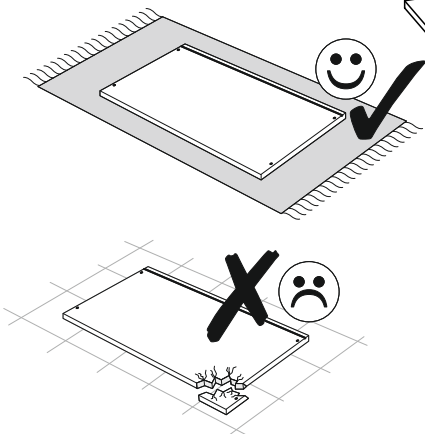
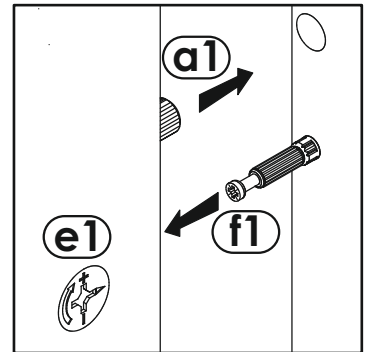
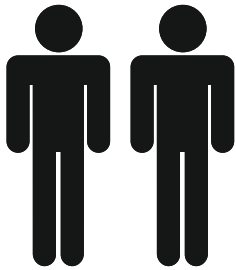

10

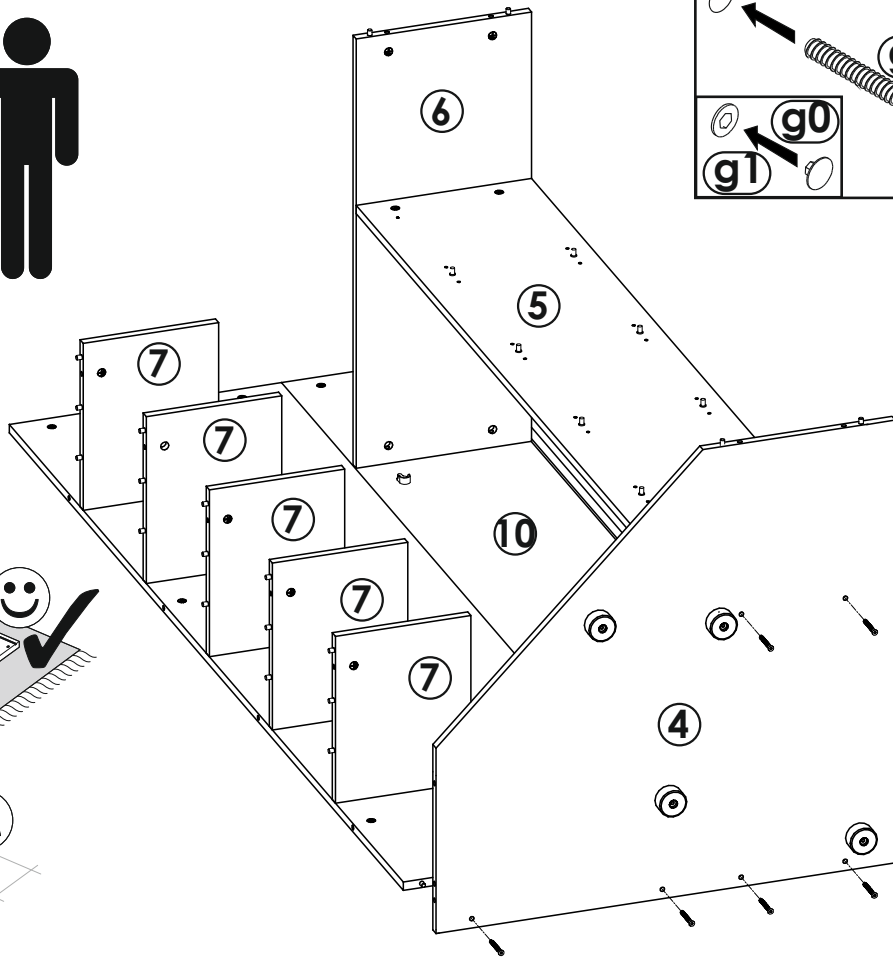
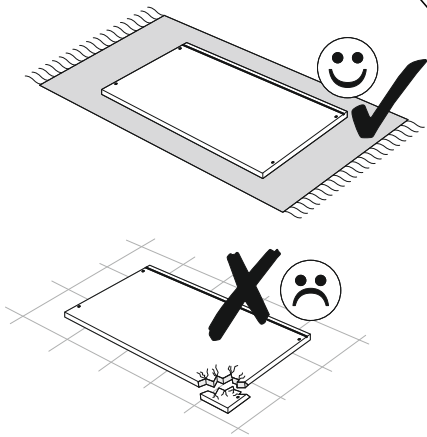
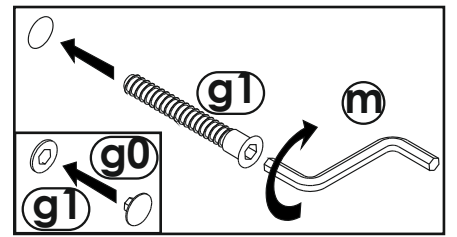
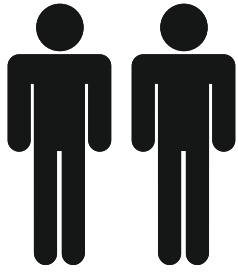

11

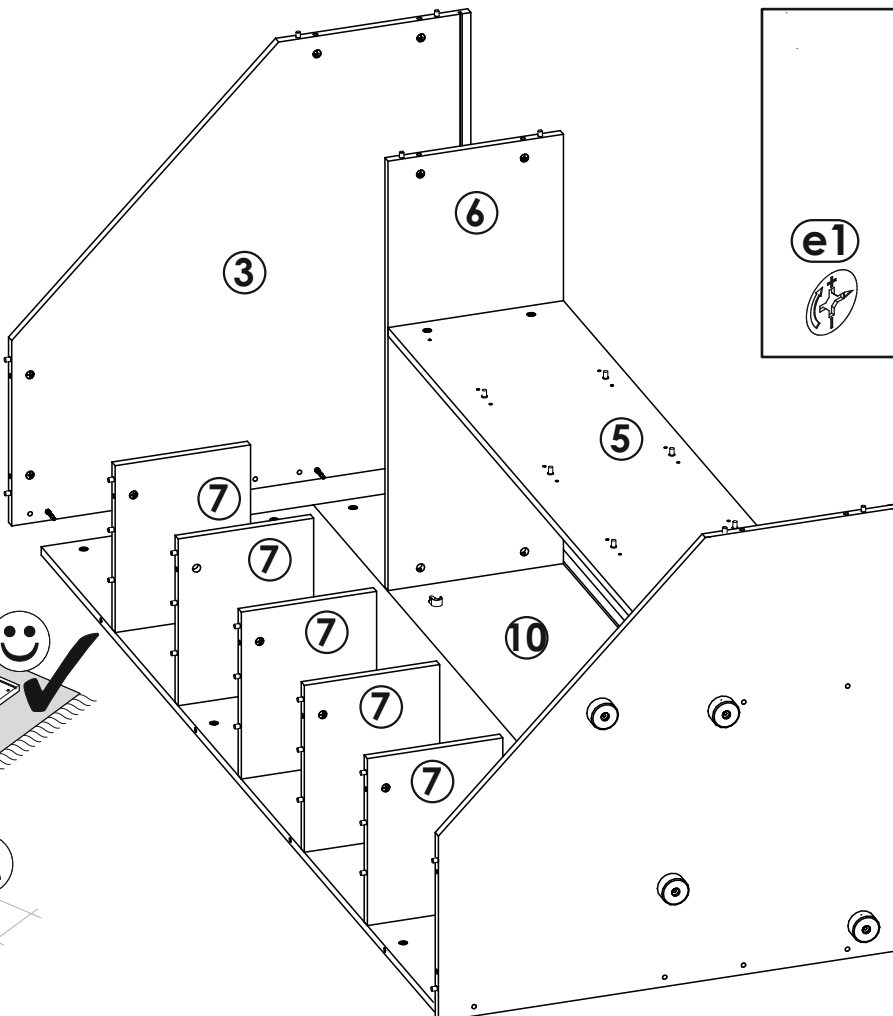
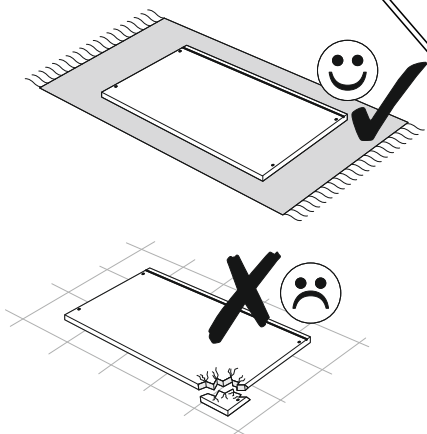
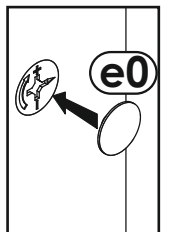
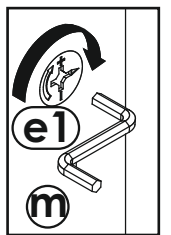
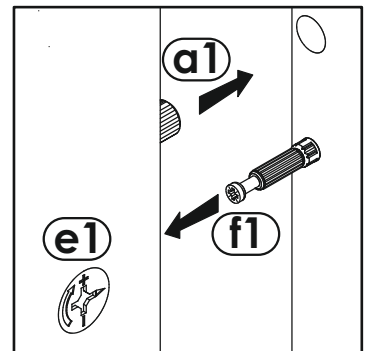

12

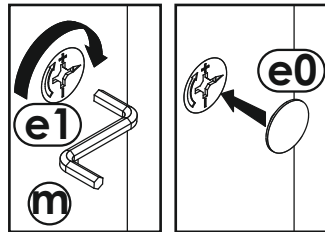
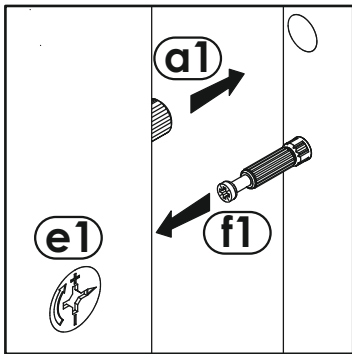
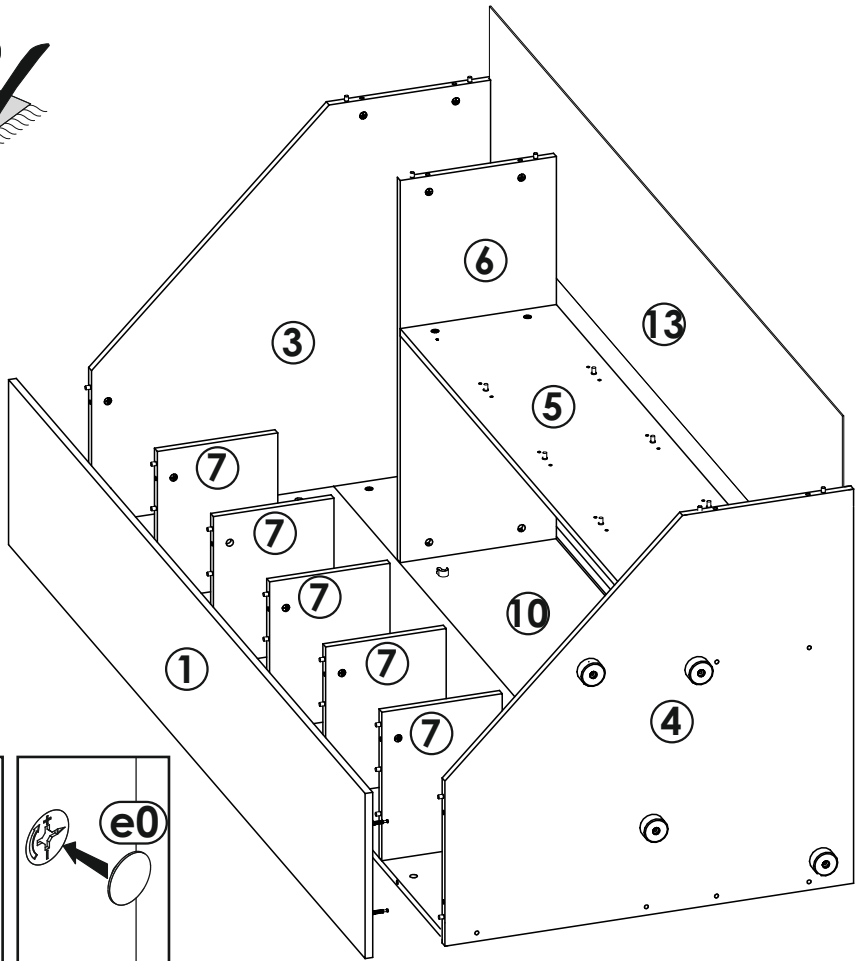
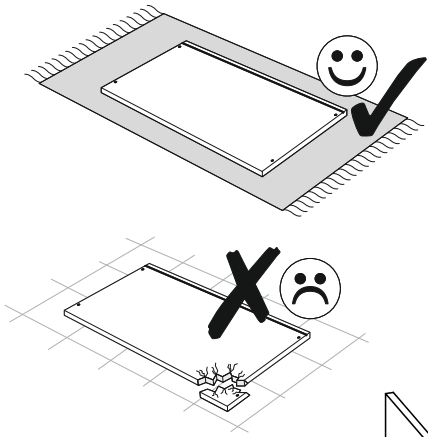

13

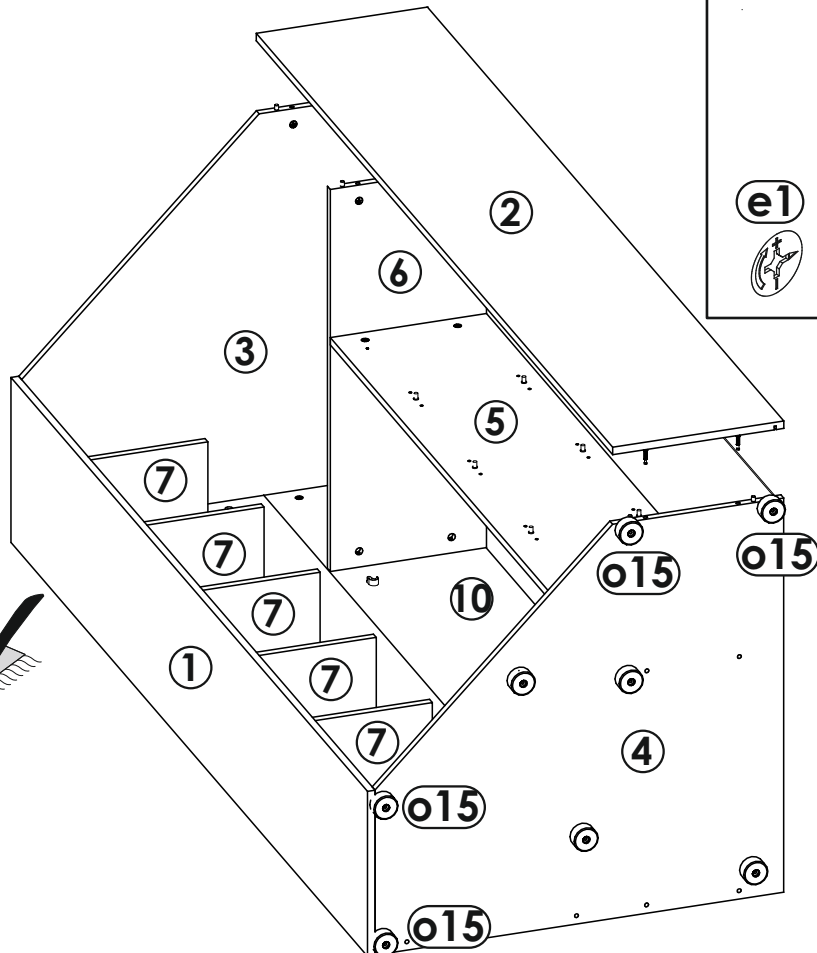
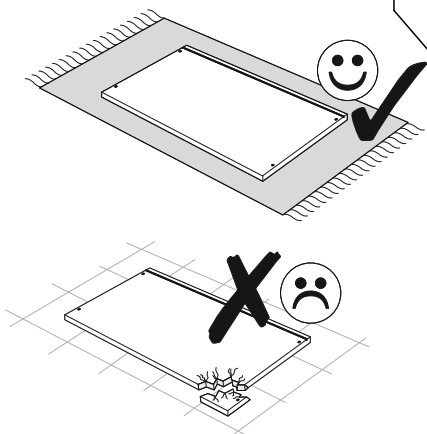
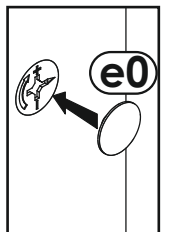
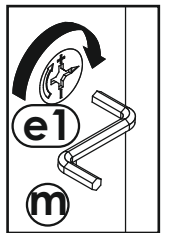
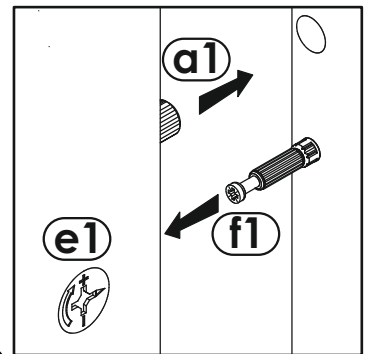
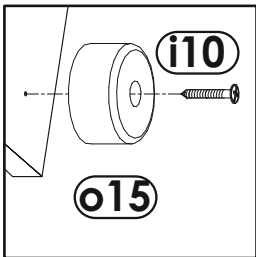

14



A=B

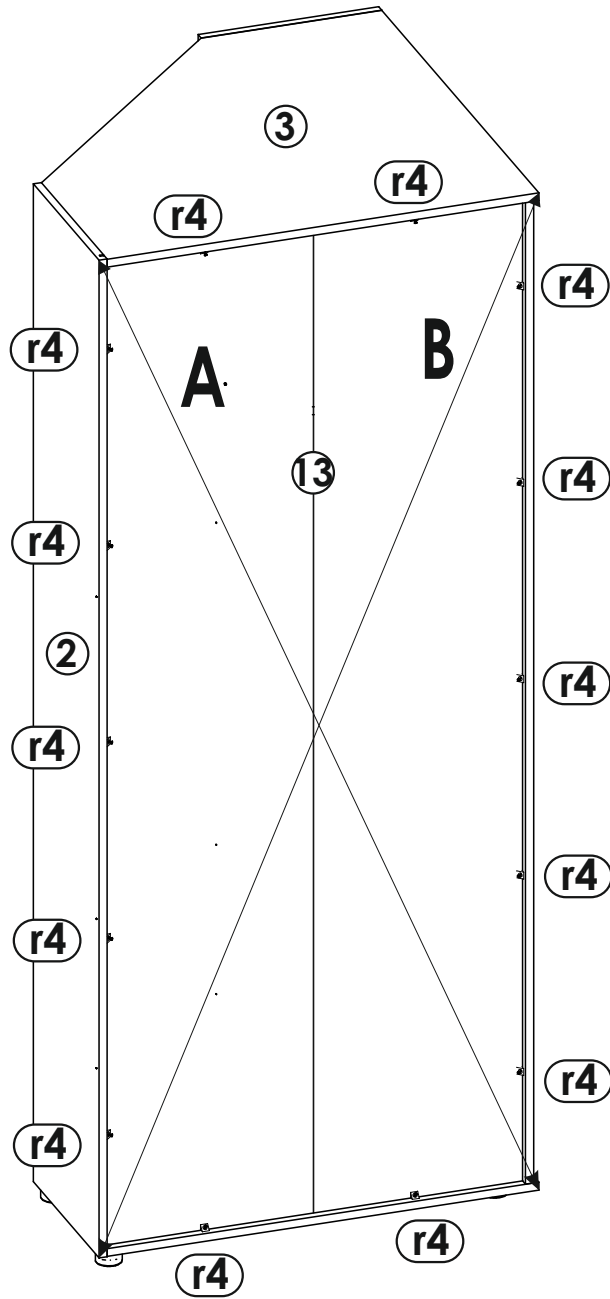
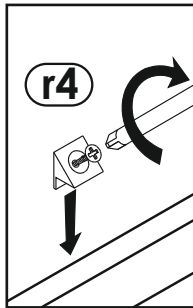

15
▼

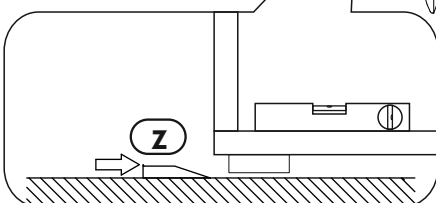
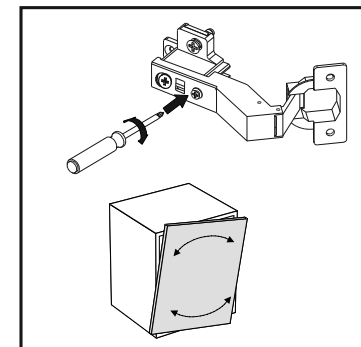
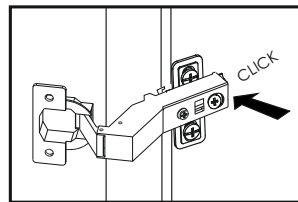
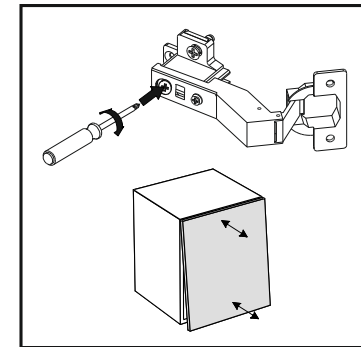
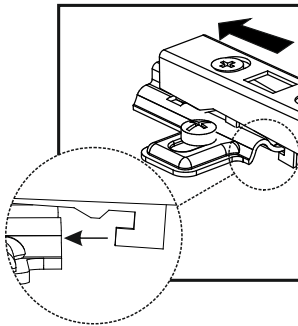
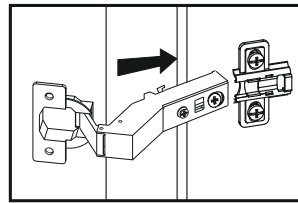
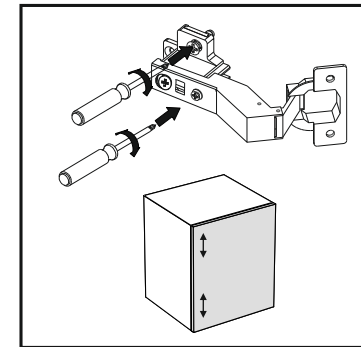
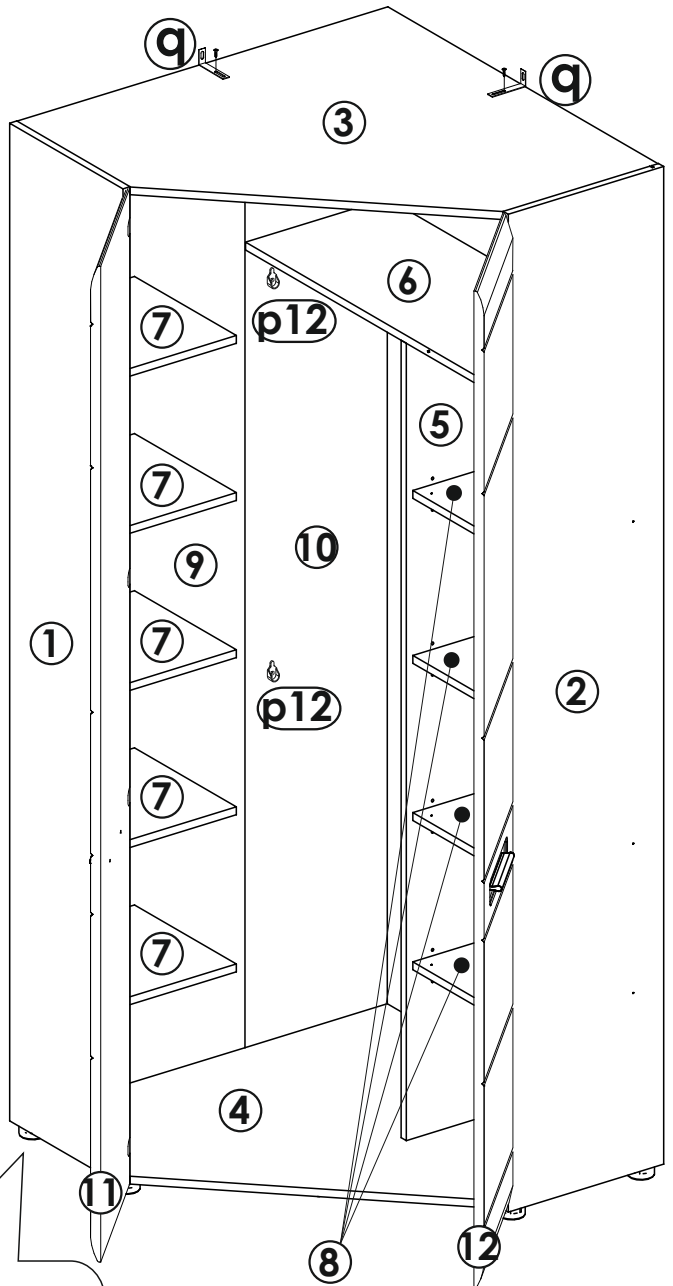
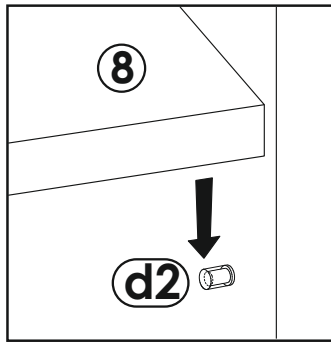
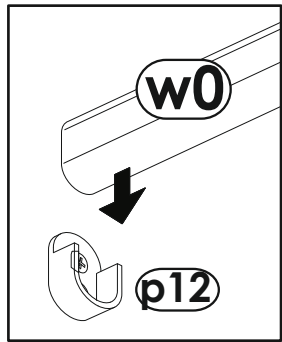
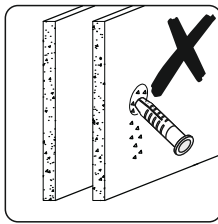
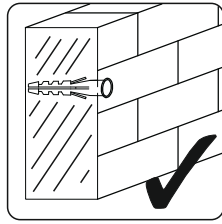
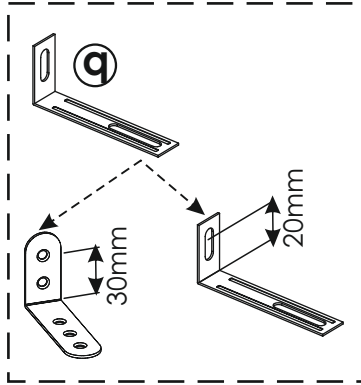
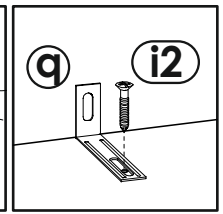
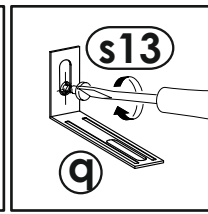
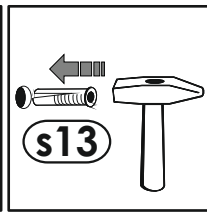
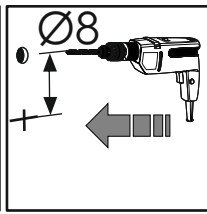
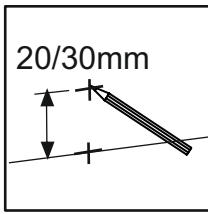
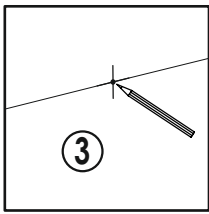

16

