

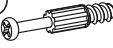





- T1**  x4
- M1**  x4
- B1**   $\phi 8 \times 28$  x4
- K1**  5x60 x8
- G7**  x1
- C2**   $\phi 13$  x14
- S13**  4x35 x10
- F15**  x2
- LED-01  x2
- LED-ZA-01  x1

Nr	Ausmaß			St
1	2146	230	28	1
2	2146	230	28	1
3	2745	229	28	1
4	2095	60	22	2
5	2745	60	22	1

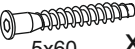

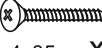

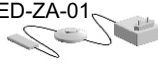
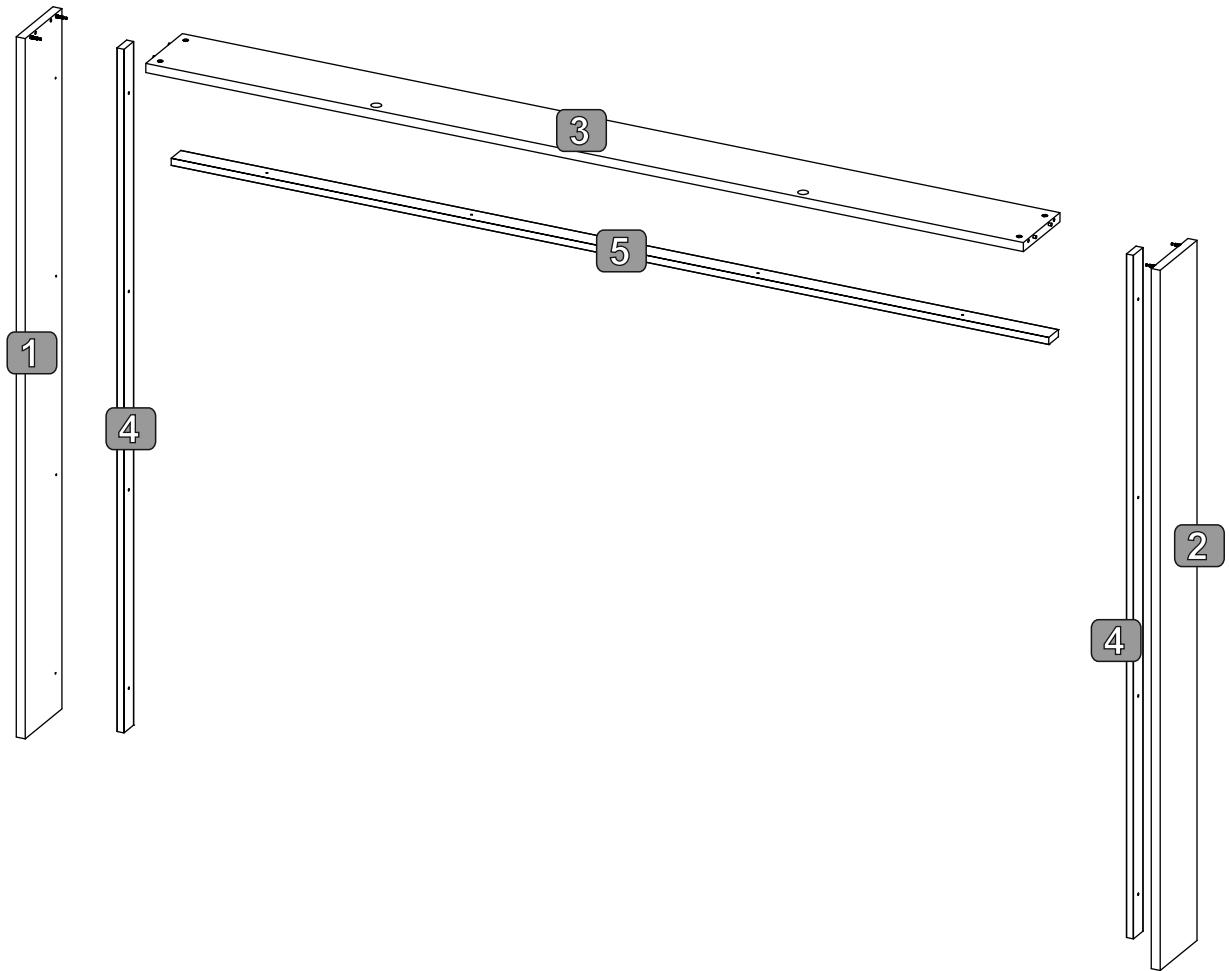
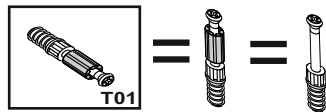

0 10 20 30 40 50 60 70 80 90 100 110 120 130 140 150 160 170 180 190 200

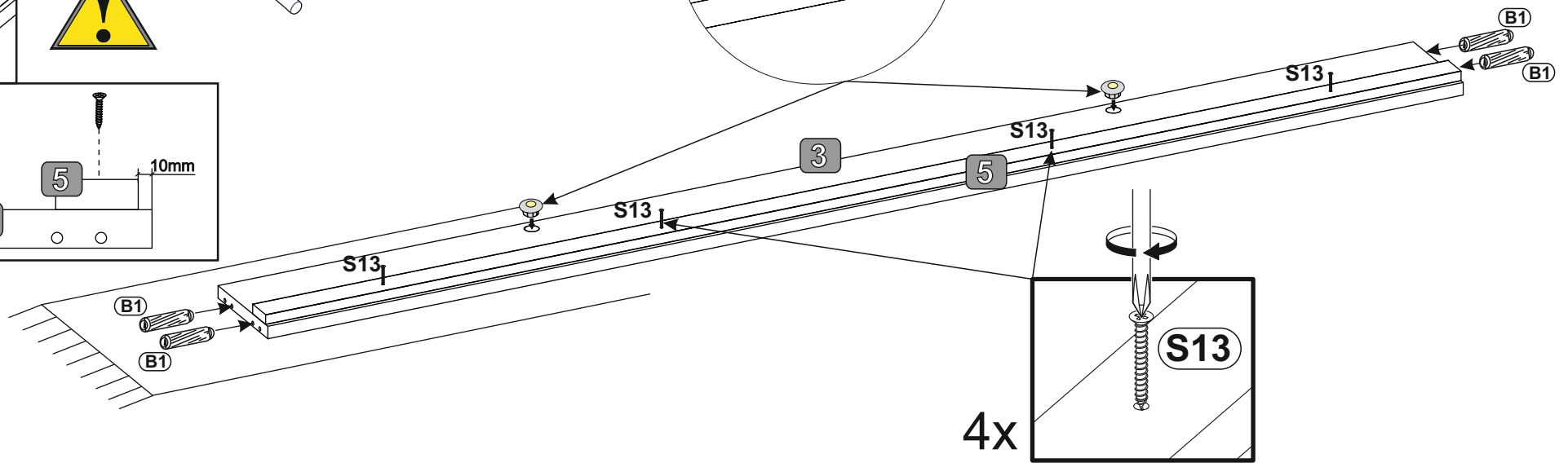
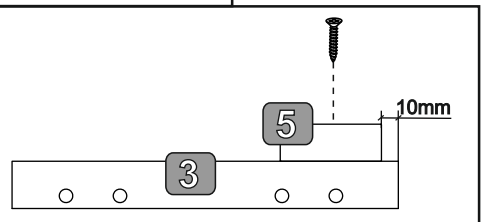
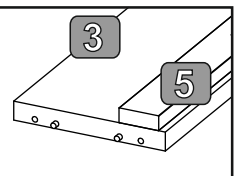
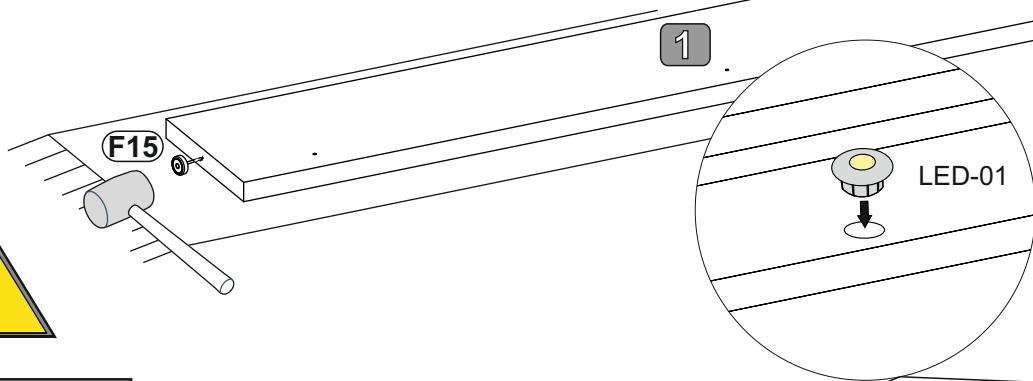
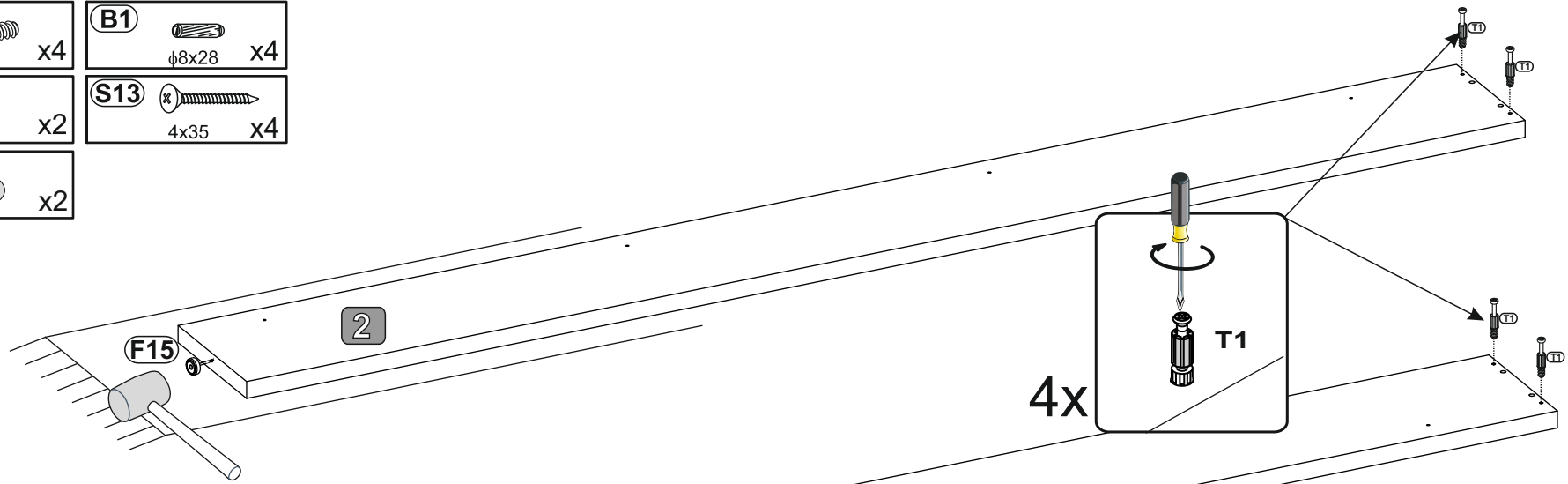
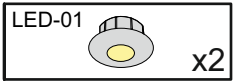
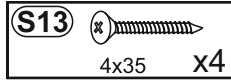
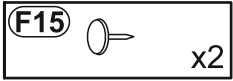
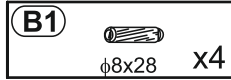
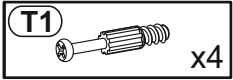

# 1

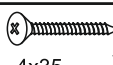

## 2

<b>M1</b>  x4	<b>K1</b>  5x60 x8	<b>G7</b>  x1
<b>S13</b>  4x35 x6	<b>C2</b>  φ13 x14	<b>LED-ZA-01</b>  x1

