

# UNIT TYP 40

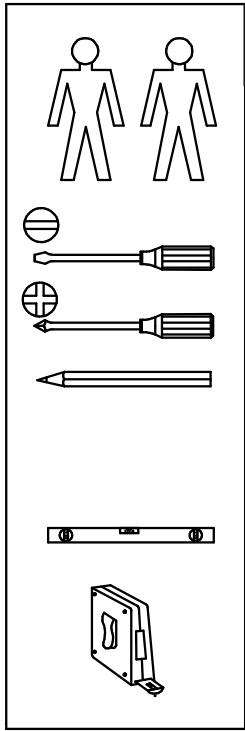

max. 10 kg

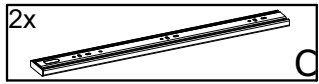

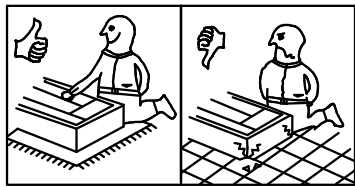
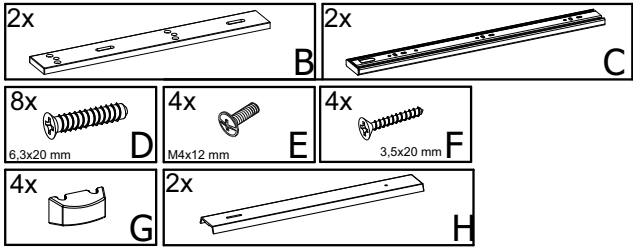
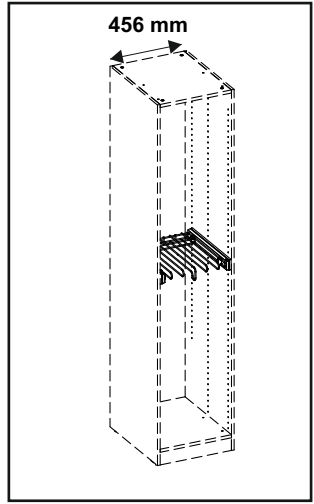
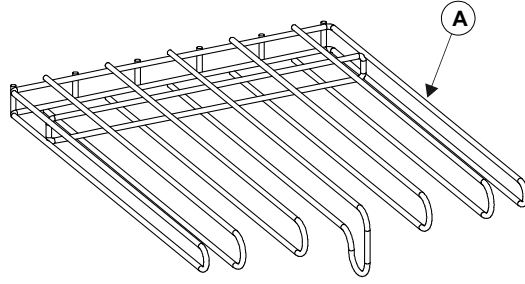

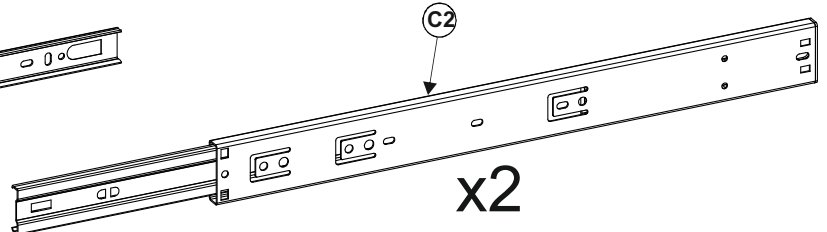
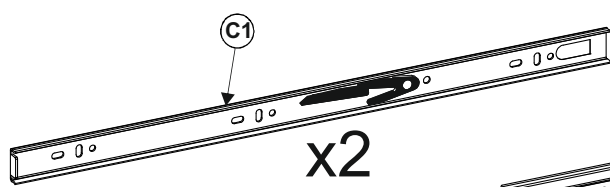
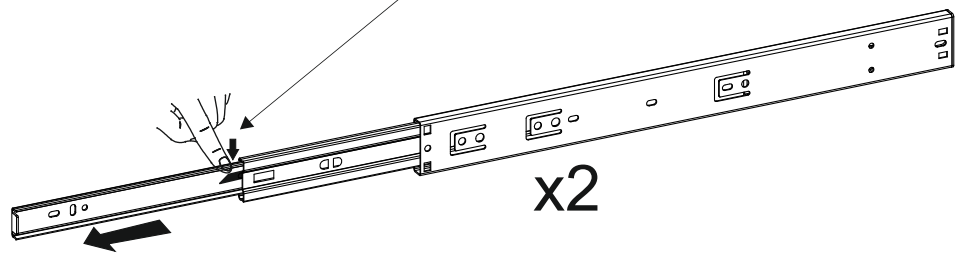
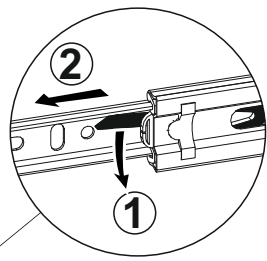
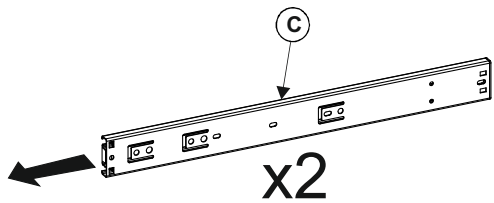
1



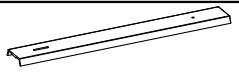

# UNIT TYP 40

## 2

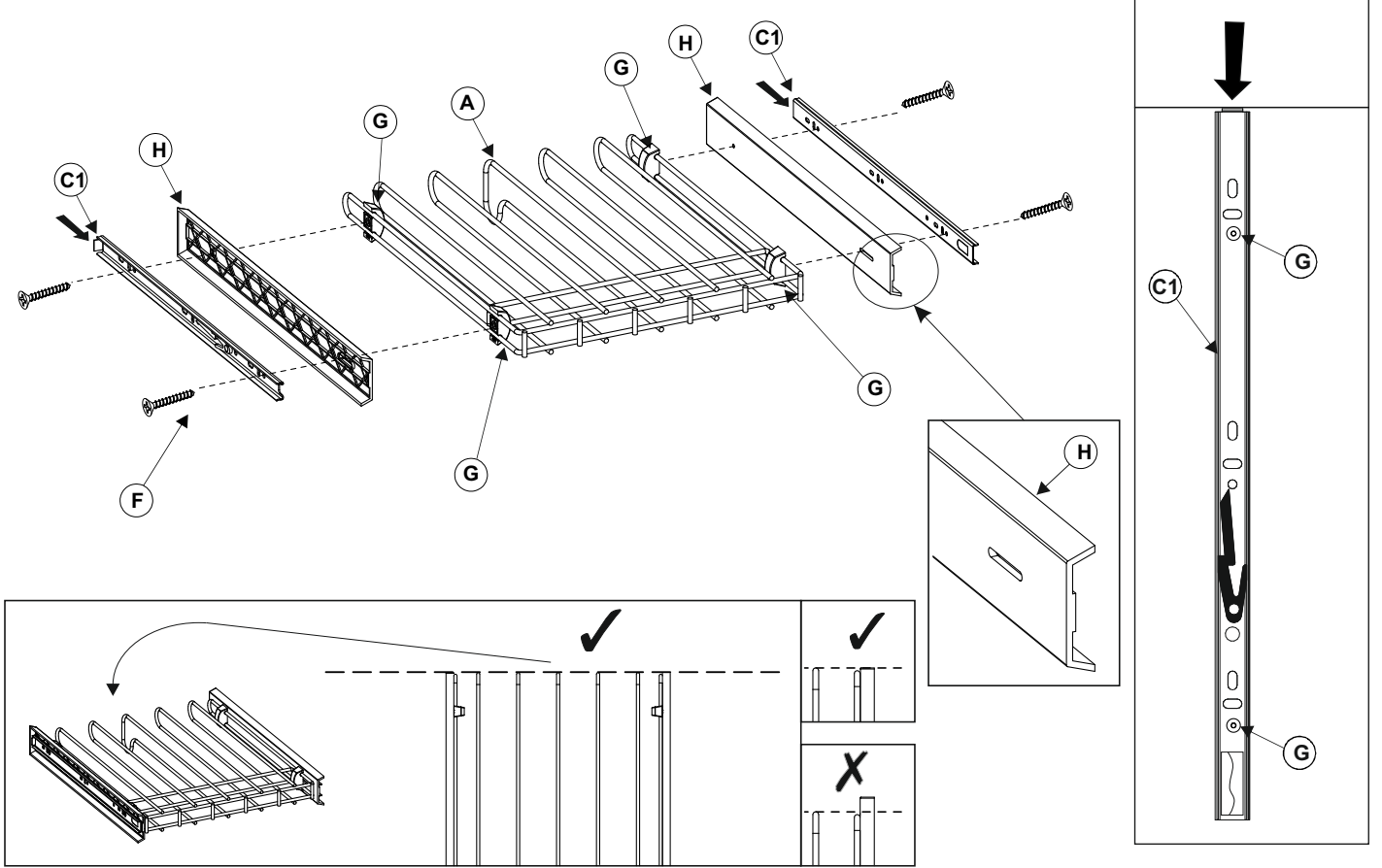
- 2x  C1
- 4x  3.5x20 mm F
- 4x  G
- 2x  H

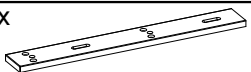

## 3

- 2x  B
- 8x  6.3x20 mm D

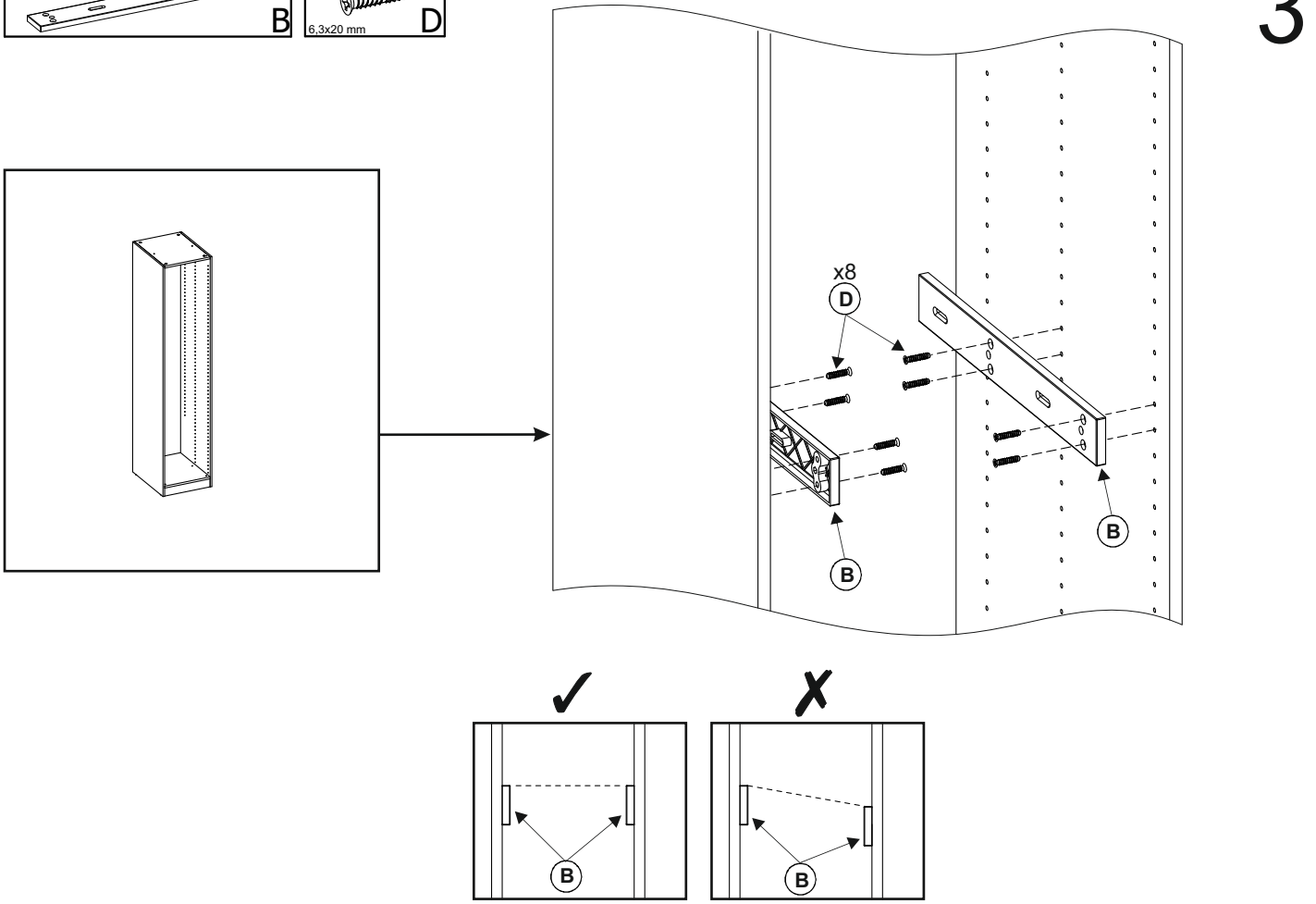

# UNIT TYP 40

# 4

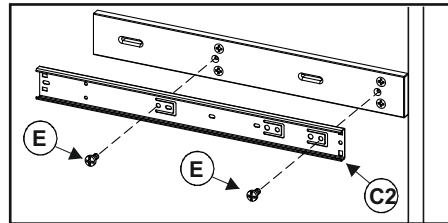
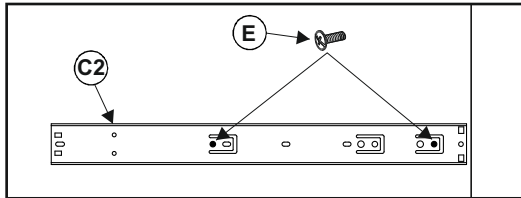
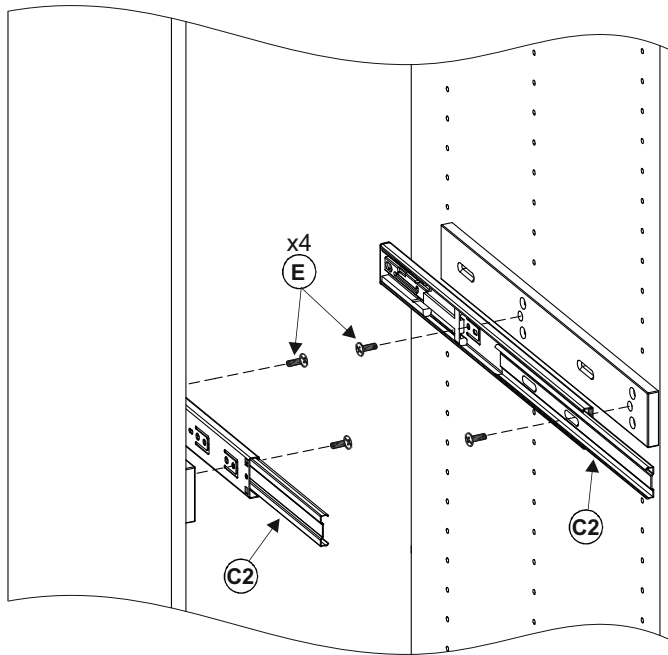
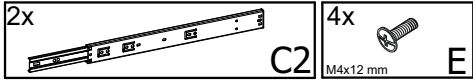

# 5

