

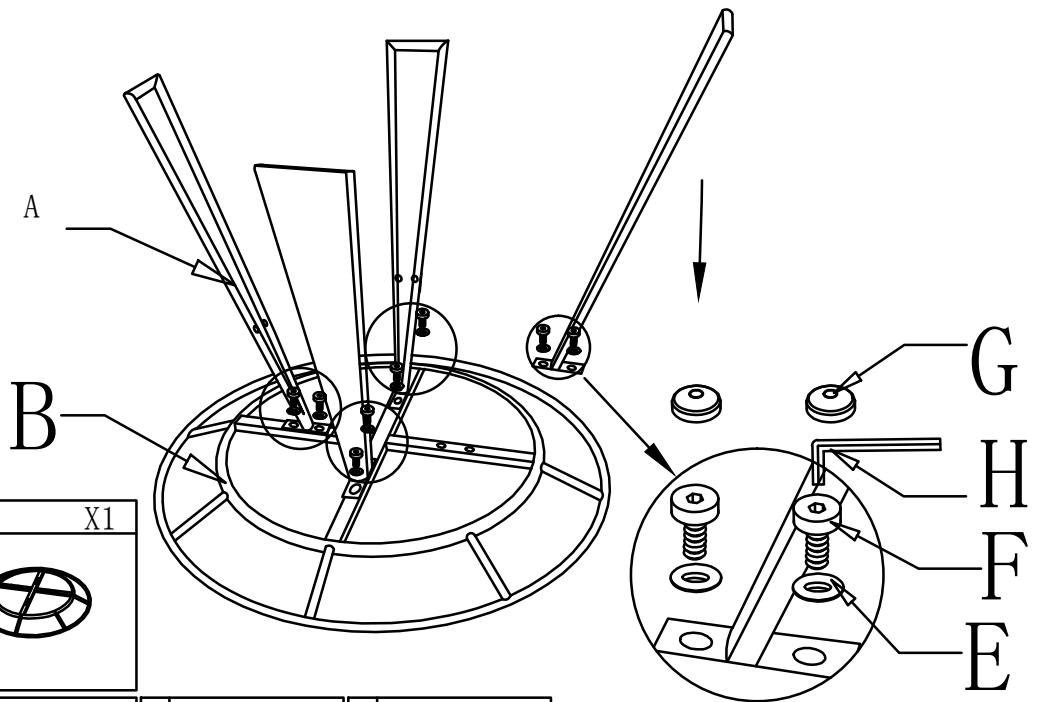





1







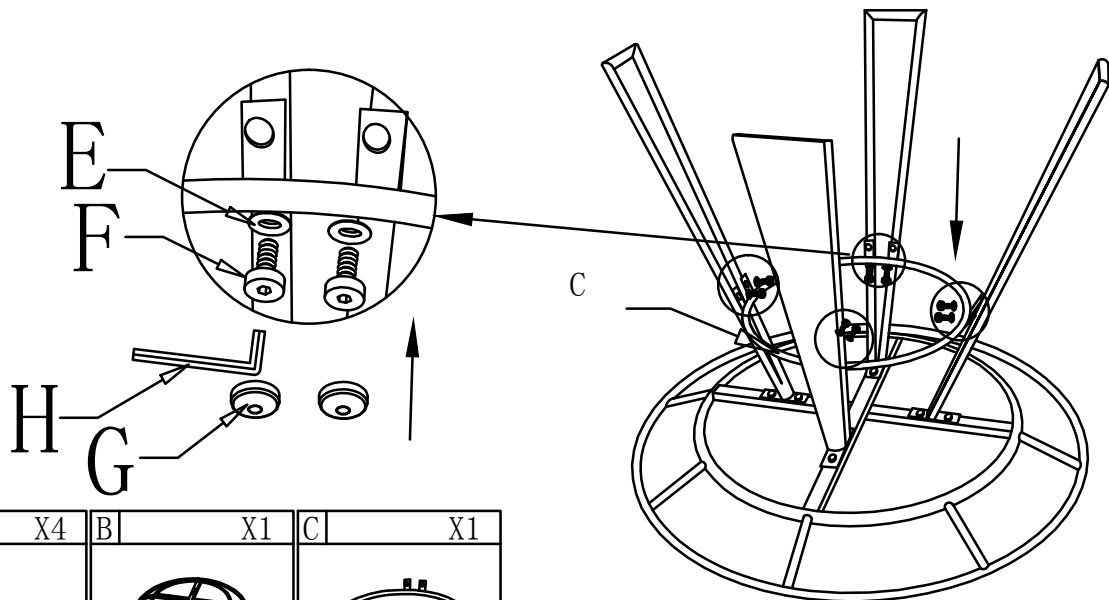

A	X4	B	X1
			

E	X16	F	X16	G	X16	H	X1
	6*18*1.0		M6*20				5#

2



A	X4	B	X1	C	X1
					

E	X16	F	X16	G	X16	H	X1
	6*18*1.0		M6*20				5#