

AVENSIS NEW 208

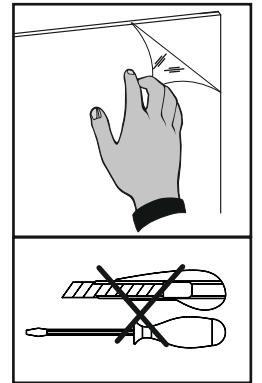

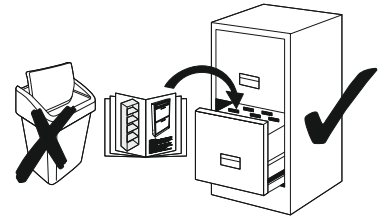

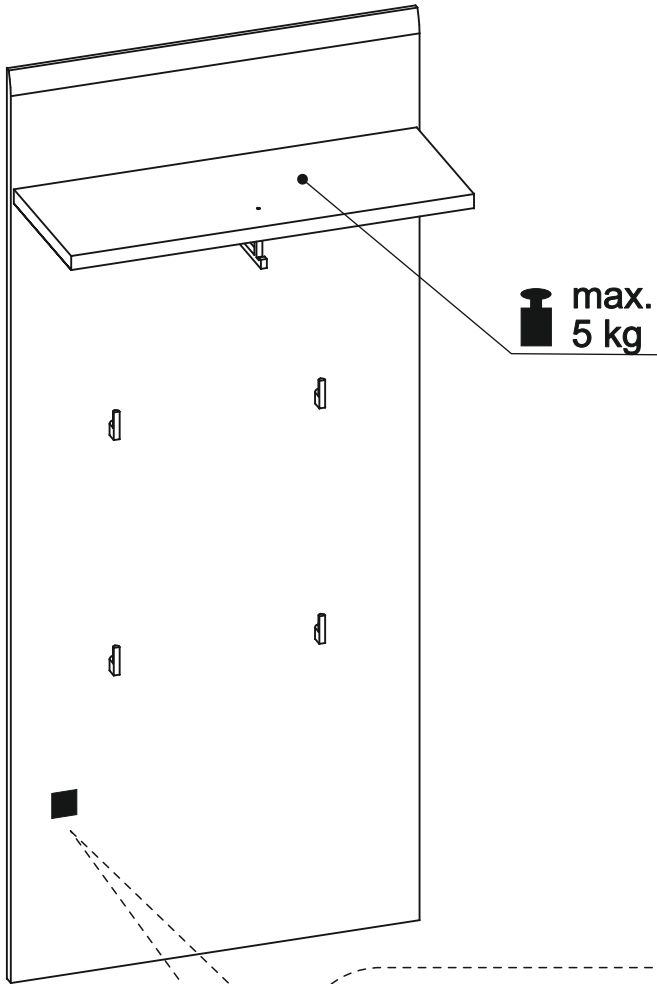





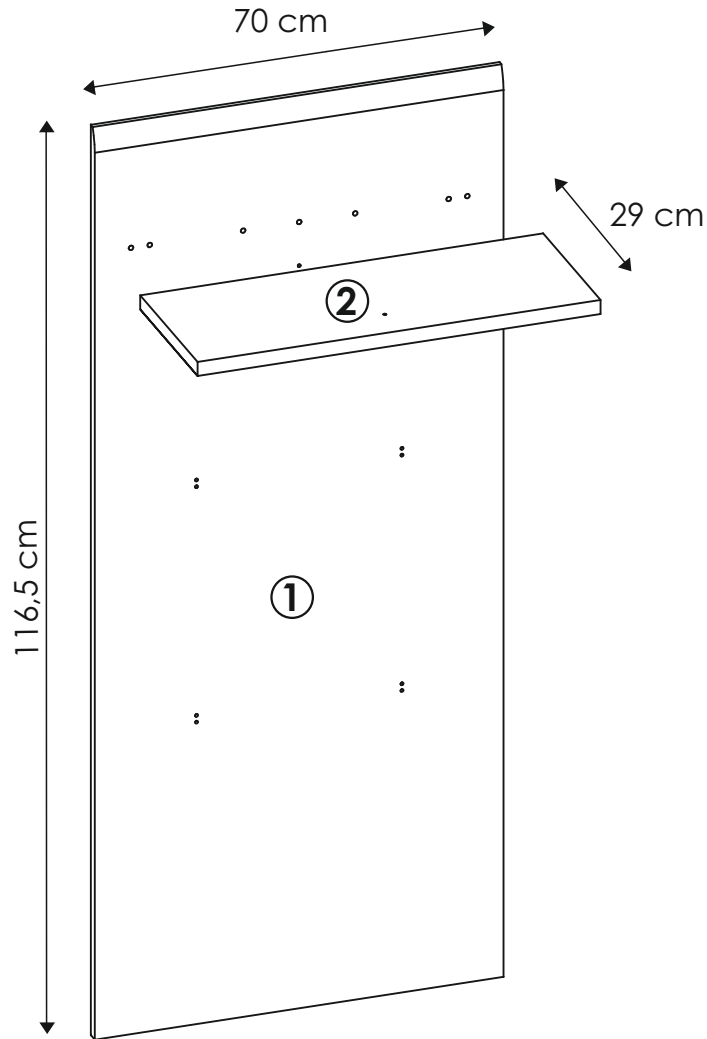



① - C1

② - C1

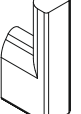

AVENSIS NEW 208



a1  8x35 X... (X3)	c2  Euro 5x13 X... (X8)	et  Luca BESSONI X... (X1)	g0  X... (X4)	g2  7x50 X... (X4)	m  X... (X1)
h4  X... (X4)	k4  4x25 X... (X9)	k5  4x30 X... (X1)	p1  X... (X4)	p26  X... (X1)	y3  φ10 X... (X4)

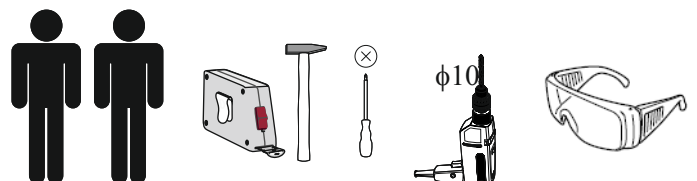

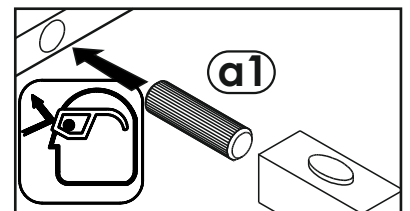
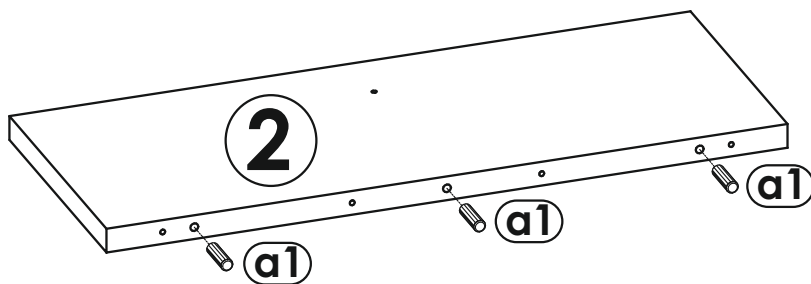
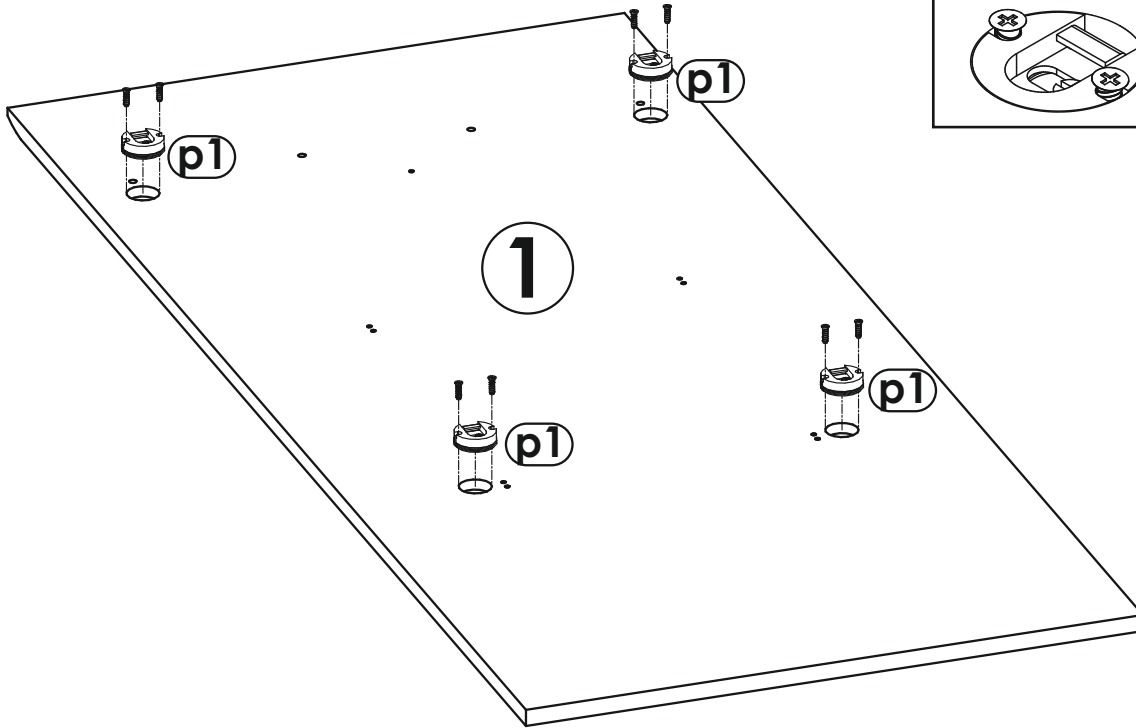
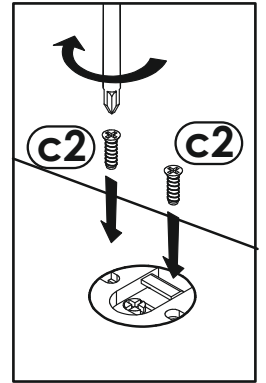
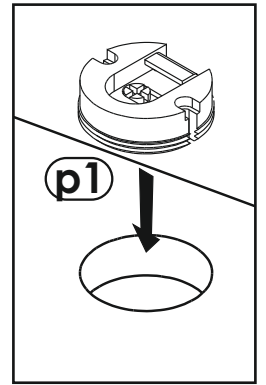
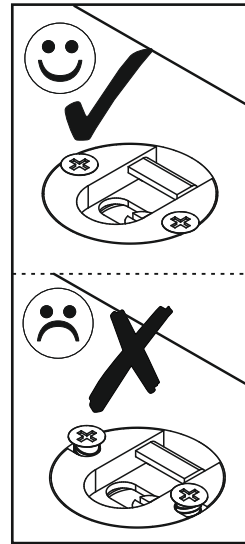
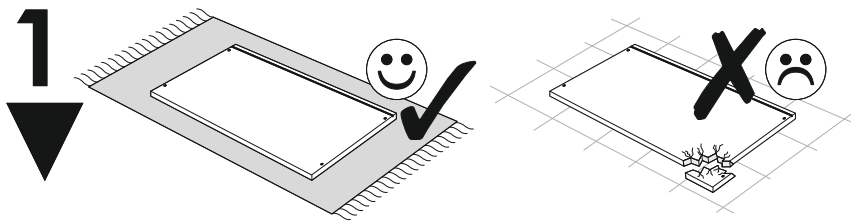

2

