

Art.-Nr.

15550077/01

SYDNEY

Z0

1/6

1400
600
1180
mm



100min



PZ1,PZ2



4



≤ 0,5 kg



3m

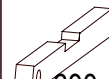

600 mm





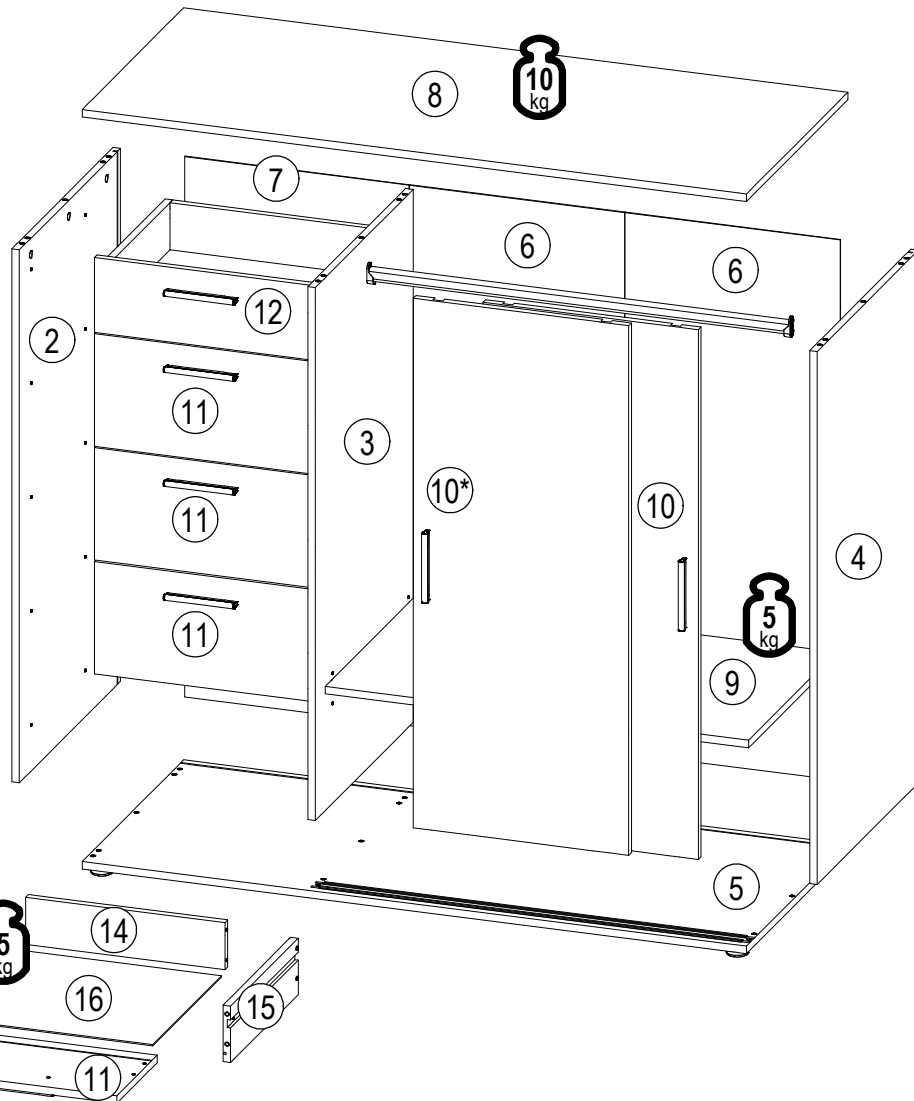
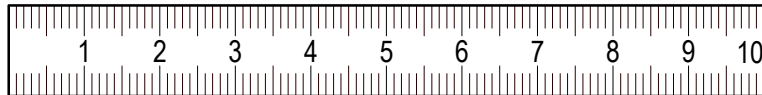



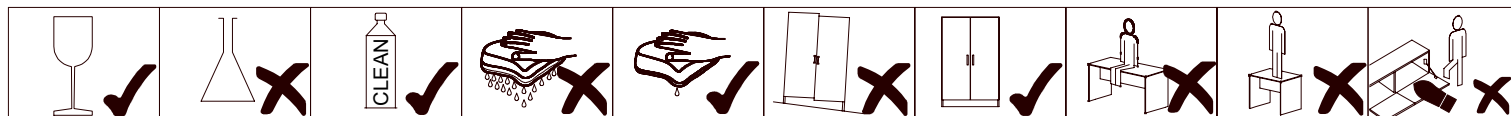



ID	ID	Icon	Dimensions	Quantity	Ratio
14606	2		1133*598*16	1x	3/3
14607	3		1133*579*16	1x	3/3
14608	4		1133*598*16	1x	3/3
14609	5		1400*600*16	1x	2/3
14610	6		1149*454*2,5	2x	1/3
14611	7		1149*473*2,5	1x	3/3
14612	8		1400*600*16	1x	2/3
14613	9		892*520*16	1x	2/3
14614	10		1126*454*16	2x	1/3
14615	11		454*239*16	4x	1/3
14616	12		454*159*16	1x	1/3
12271	13		400*120*16	5x	1/3
14617	14		420*100*16	5x	1/3
07408	15		400*120*16	5x	2/3
14618	16		406*430*2,5	5x	1/3



27000,00	70013,01	70021,01	32030,00	22236,00	22213,00	30080,00	22705,00	22244,01	22250,00
A 13x	B 29x	C 29x	D 7x	E 10x	F 1x	G 7x	H 20x	J 30x	K 7x
31103,00	22243,00		70017,55	24103,00	22430,00	22300,00	22502,00	24008,00	35101,01
L 1x	M 14x	N 29x	P 1x	Q 1x	R 14x	S 29x	T 10x	U 10x	V 4x
70018,01	50553,00	33018,00	30006,01	30007,01					
W 2x	X 18x	Y 5x	Z1 4x	Z2 4x					





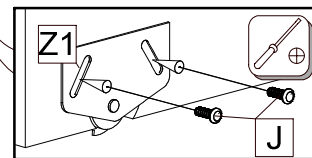
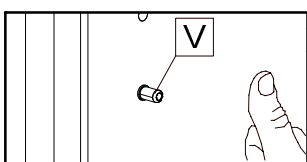
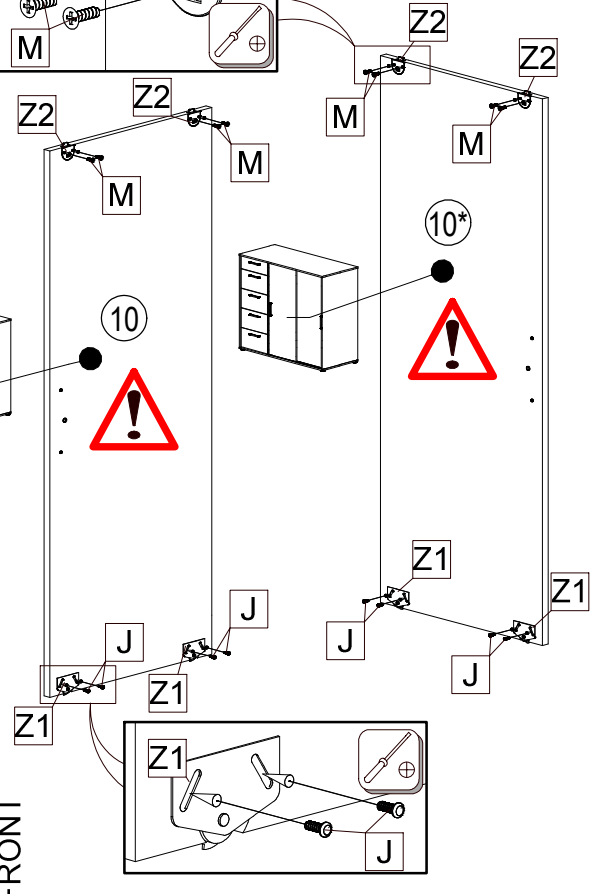
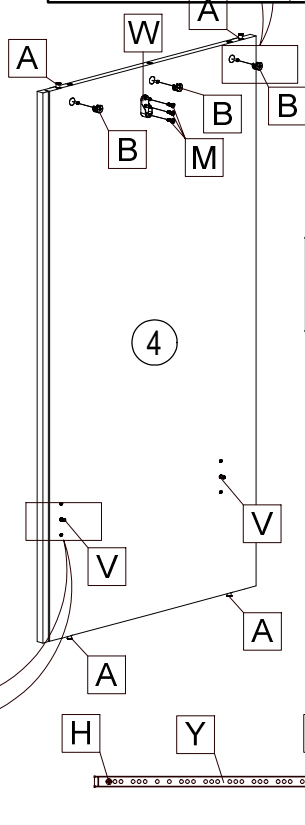
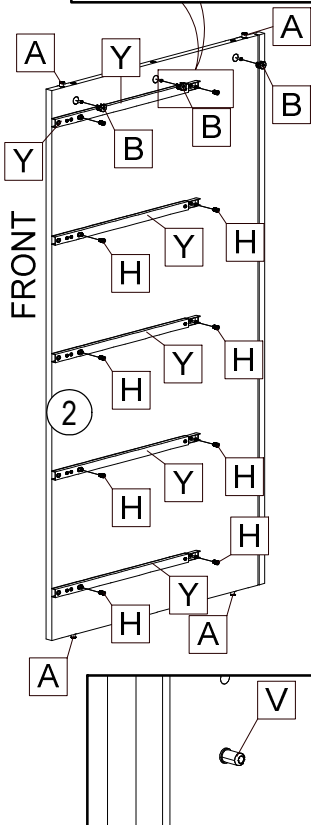
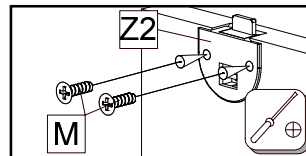
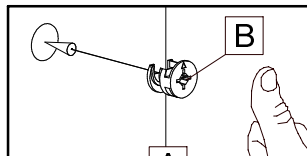
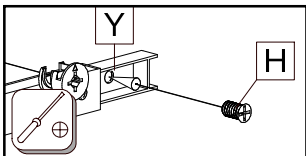
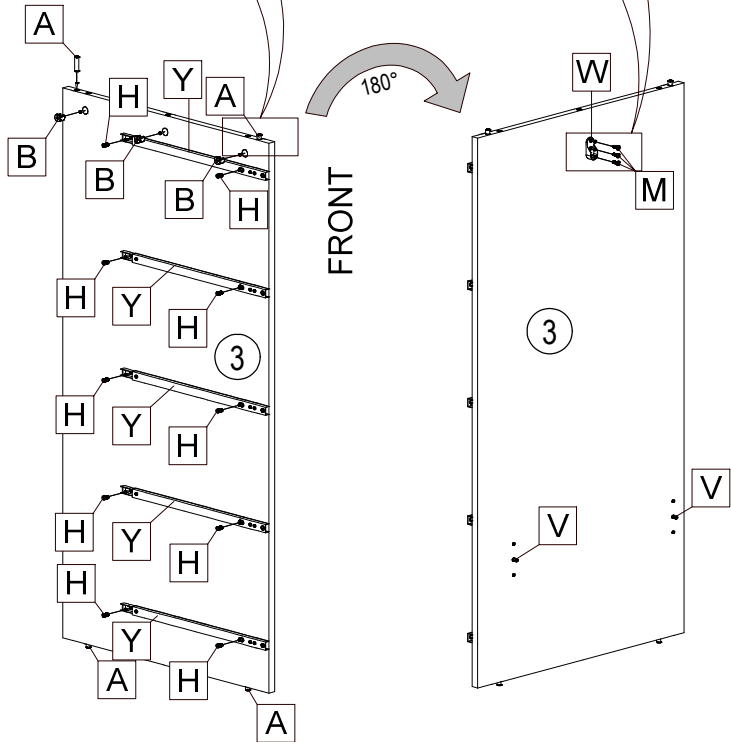
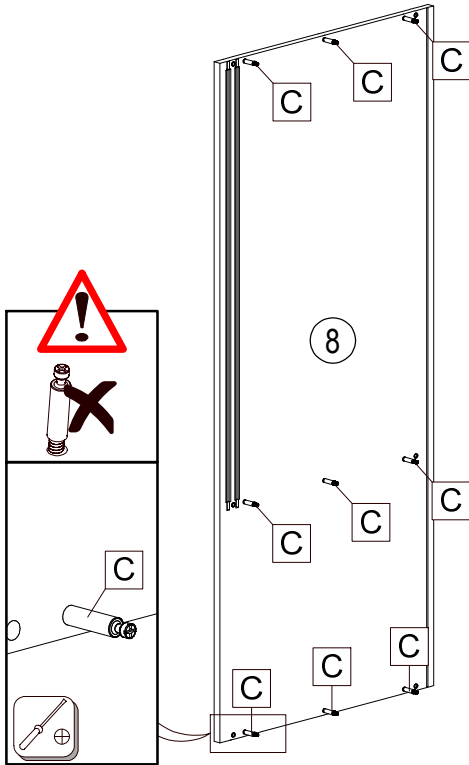
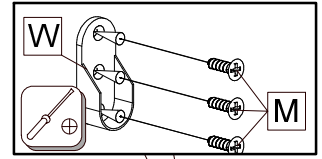
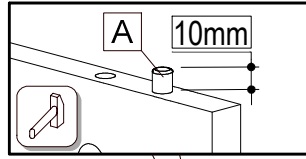

								
A 12x	B 9x	C 9x	H 20x	J 8x	M 14x	V 4x	W 2x	Y 5x
								
Z1 4x	Z2 4x							

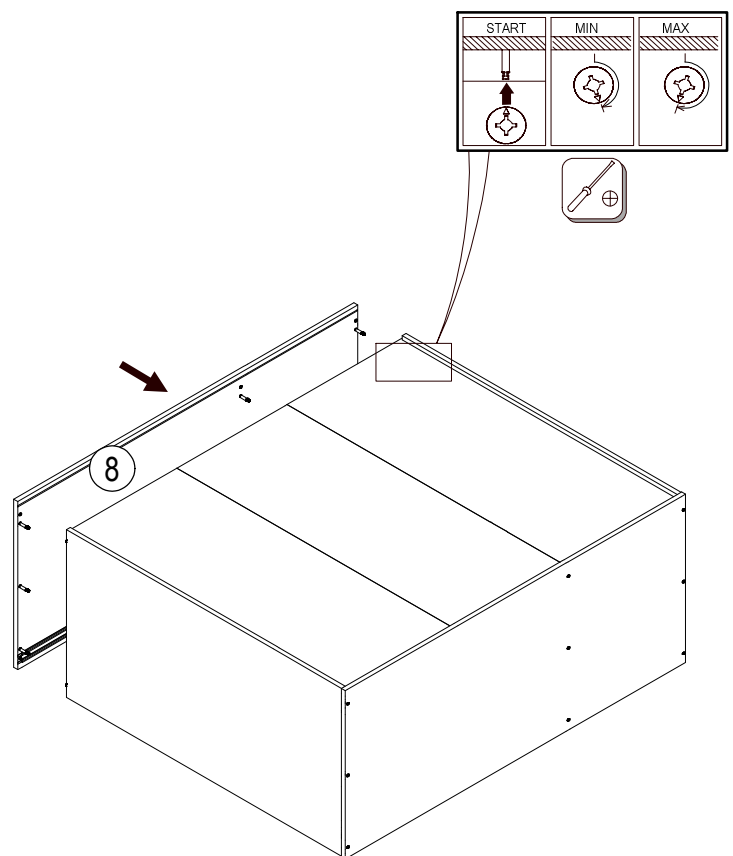
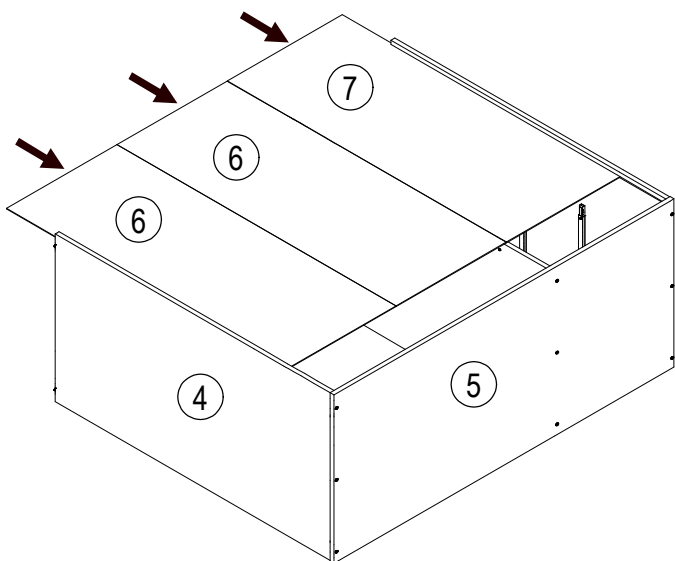
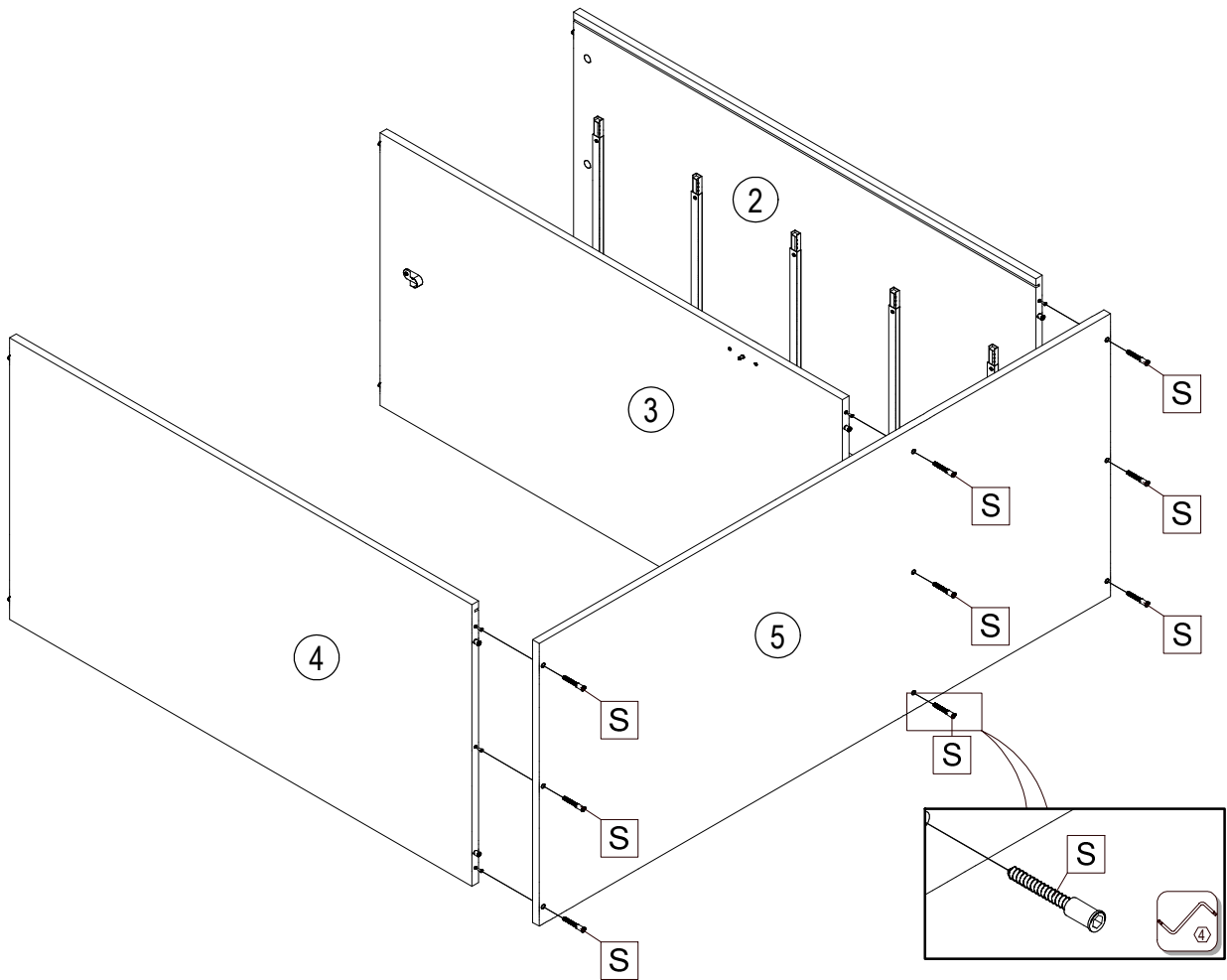





	Ø7x50
S	9x

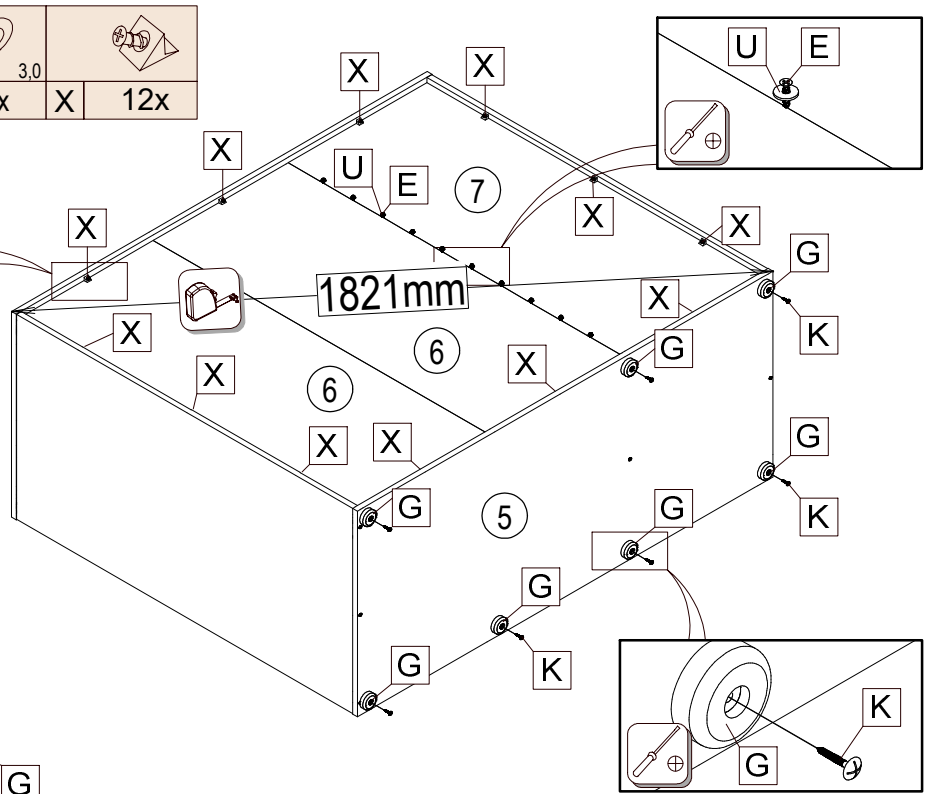
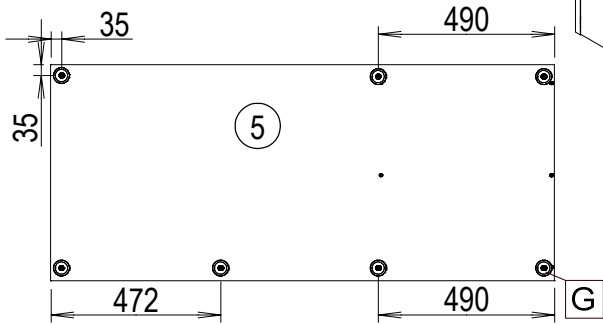
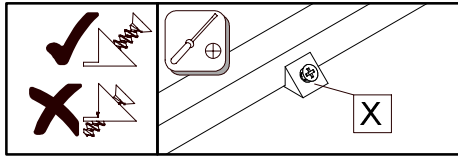

				
Ø2,5x16		Ø4x25	3,0	
E 10x	G 7x	K 7x	U 10x	X 12x



			
Ø4x70	Ø3,5x16		Ø8
F 1x	J 2x	L 1x	Q 1x

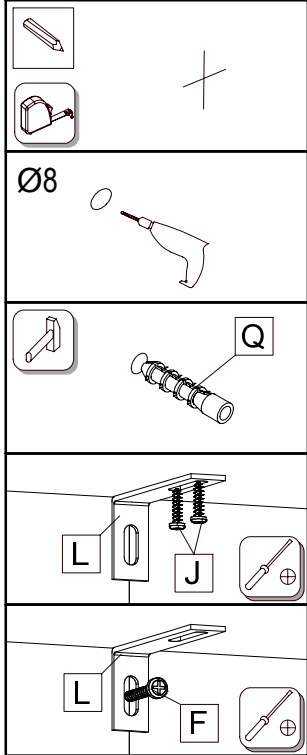
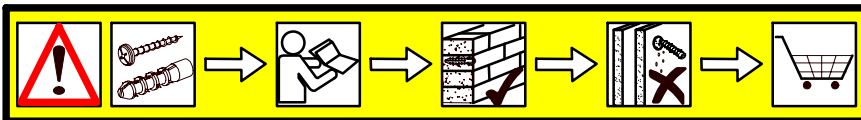

Caution! The wall must be examined before assembly. The included universal wall plugs are only suitable for using in firm masonry such as concrete block or brick. Do not use the wall plugs in masonry such as hollow brick, lightweight block, surfaces such as gypsum plasterboard or other framing systems. If applicable, particular wall plugs must be used! These are available at a specialised store (hardware store). In case of non-compliance, the manufacturer/retailer or importer do not assume liability.

Upozornenie! Pevnosť steny sa musí pred montážou bezpodmienečne skontrolovať. Univerzálne hmoždenky, ktoré sú obsiahnuté v balení, používajte jedine pre pevné mŕtvo ako je betón/tehla. Hmoždenky sa nesmú používať v prípade ľahkého stavebného muriva, dutina tehla, u sádrokartónových dosiek, alebo iných konštrukcií rámu. U týchto murív je nutné použiť špeciálne hmoždenky! Tieto je možné dostať v špeciálnych predajniach so stavebným materiálom (stavebniny). Pri nedodržaní pokynov nepreberajú výrobcovia/predajci a dodávateľia zodpovednosť za vzniknuté škody.

OBS! Väggers sammansättning ska absolut kontrolleras innan montering. De bifogade pluggarna får endast användas för stabila och fasta väggar, som t.ex. betong/tegel. De får absolut inte användas för kaviteter, väggar ur fonoll, gipskivor eller dylikt. För dessa väggar måste det användas speciella pluggar, som finns att köpa i specialiserad handel (byggmarknad). Varken tillverkare, handlare eller importör övertar ansvar, om dessa anvisningar inte följs.

Upozornění! Před montáží je nutné zkontrolovat stav stěny. Přiložené univerzální hmoždinky jsou určeny pouze k použití pro pevné zdivo jako beton/cihly. Hmoždinky do zdi se nesmí používat u dutinová cihla, zdiva jako pórovitý stavební kámen, sádrokartónová deska nebo jiný měkký materiál. U těchto zdív jsou nutné použít speciální hmoždinky! Jsou k dostání v speciálních prodejnách se stavebním materiálem. Při nedodržení těchto pokynů výrobce/prodejece a dovozce neručí za způsobené škody.





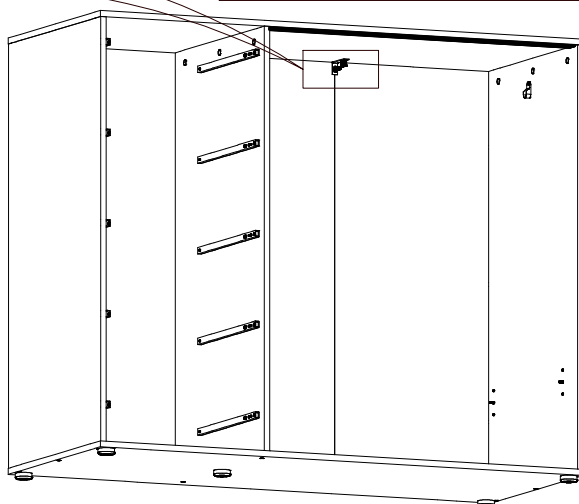

Pažnja! Prije montaže obvezno provjerite svojstvo zida. Priložene univerzalne tiple namijenjene su isključivo za masivne zidove od betona/opeke. Tiple za masivne zidove ne smiju se koristiti za zidove kao npr. supljina opeka laki sastavni elementi, gips-kartonske ploče ili drugi modularni načini gradnje. Za te zidove potrebne su eventualno specijalne tiple! Iste su dostupne u specijaliziranim trgovinama građevinskim materijalom. U slučaju nepridržavanja prethodno navedenih napomena, proizvođač/trgovca i uvoznik ne preuzimaju odgovornost!

Pozor! Pred montažu proverite stanje stene. Priloženi univerzalni mozniki so izključno samo za uporabo na čvrstem zidovju, kot sta beton in opeka. Stenski mozniki se ne smejo uporabljati pri zidovju kot so votlino opeke, zidaki za lahko gradnjo, mavčne plošče ali druge okvirne gradnje. Pri teh zidovjih morate v danih primerih uporabljati posebne moznike. Ti so na voljo v specializiranih trgovinah (trgovinah z gradbenim materijalom). Pri upoštevanju se s strani proizvajalca/trgovca in uvoznika ne prevzame jamstvo.



Achtung! Die Wandbeschaffenheit ist vor der Montage unbedingt zu prüfen. Die beigelegten Universaldübel sind ausschließlich nur zur Verwendung für festes Mauerwerk wie Beton/Ziegel. Die Mauerdübel dürfen nicht bei Mauerwerk wie Hohlraumziegel, Leichtbausteinen, Gipskartonplatte oder anderer Rahmenbauweise verwendet werden. Bei diesen Mauerwerken sind gegebenenfalls Spezialdübel zu verwenden! Diese sind in einem Fachgeschäft (Baumarkt) erhältlich. Bei Nichteinhaltung wird seitens Produzenten/Händler und Importeur keine Haftung übernommen.

Vigyázat! Szerelés előtt a falfelületet feltétlenül vizsgálja meg. A mellékelt univerzális tiplik kizárólag stabil falazathoz használható mint például beton/tegla. A fal tiplik nem használható könnyű építőkövekhez, üreg téglák, gipszkarton lapokhoz vagy más favázás építményekhez. Ezekhez a falfelületekhez csak speciális tiplik használhatóak, melyek szaküzletekben (barkácsruházakban) beszerezhetőek. Fentiek figyelmen kívül hagyása esetén a gyártó/kereskedő vagy forgalmazó nem vállal felelősséget.

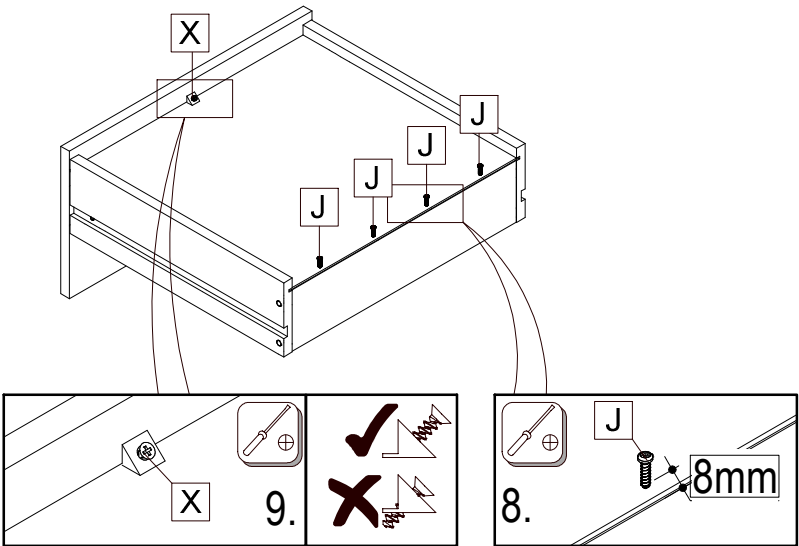
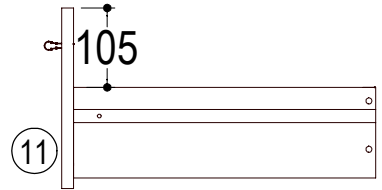
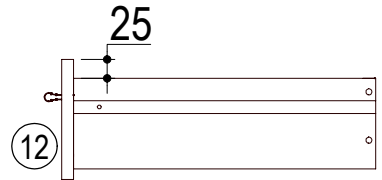
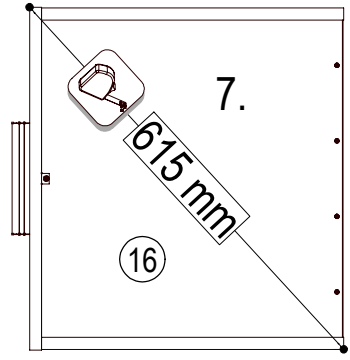
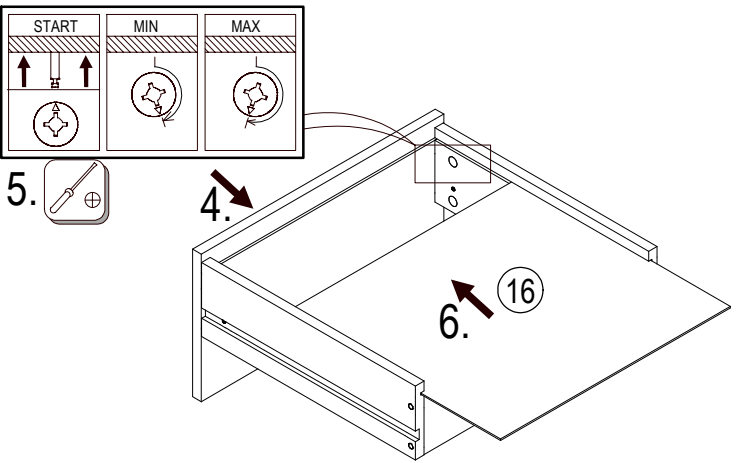
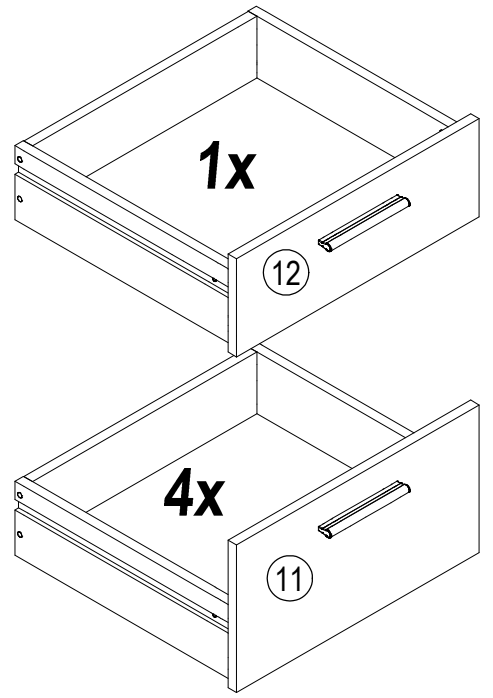
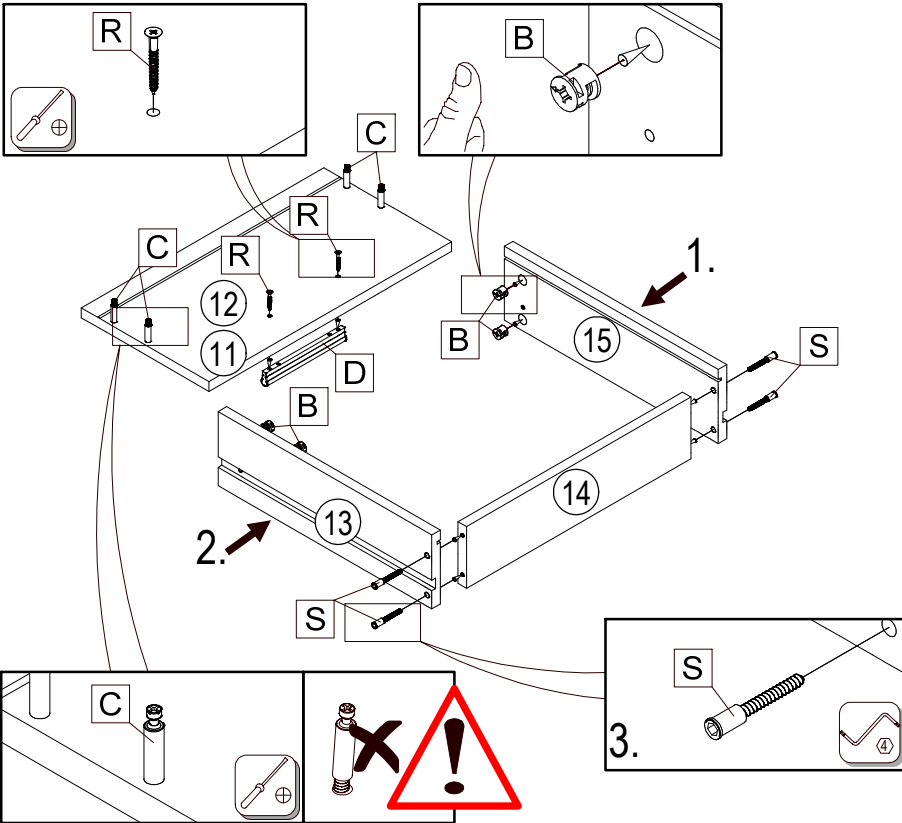

						
B 20x	C 20x	D 5x	J 20x	R 10x	S 20x	X 5x



		
N 29x	M4x12 T 10x	P 884mm 1x

