

1803

KASHMIR KAG02

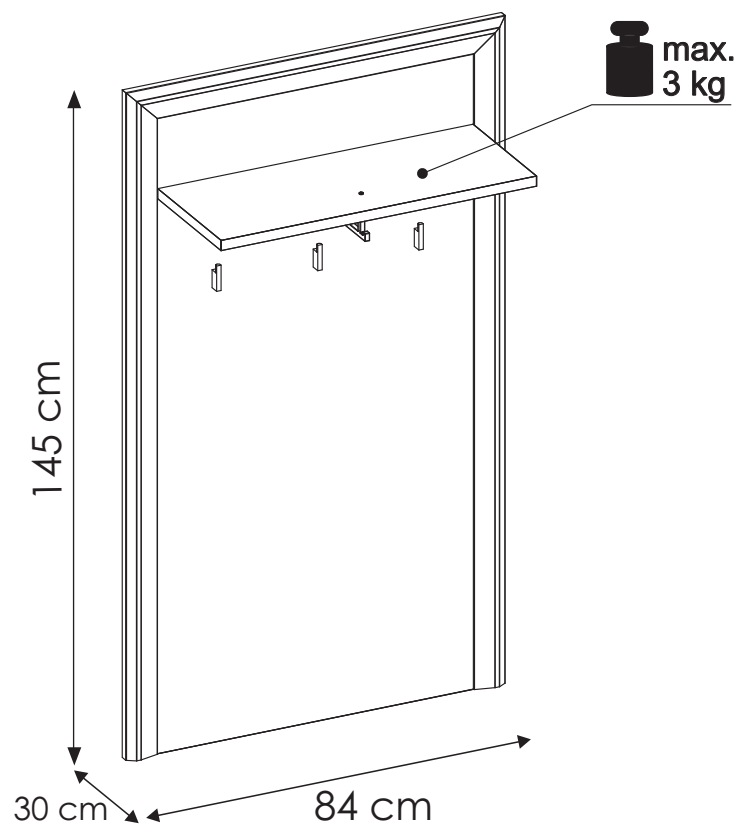

- 15 min.



① - C1

② - C1

③ - C1









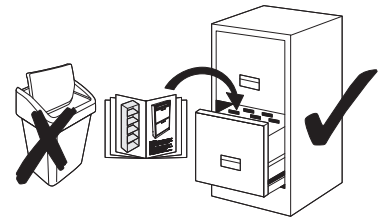
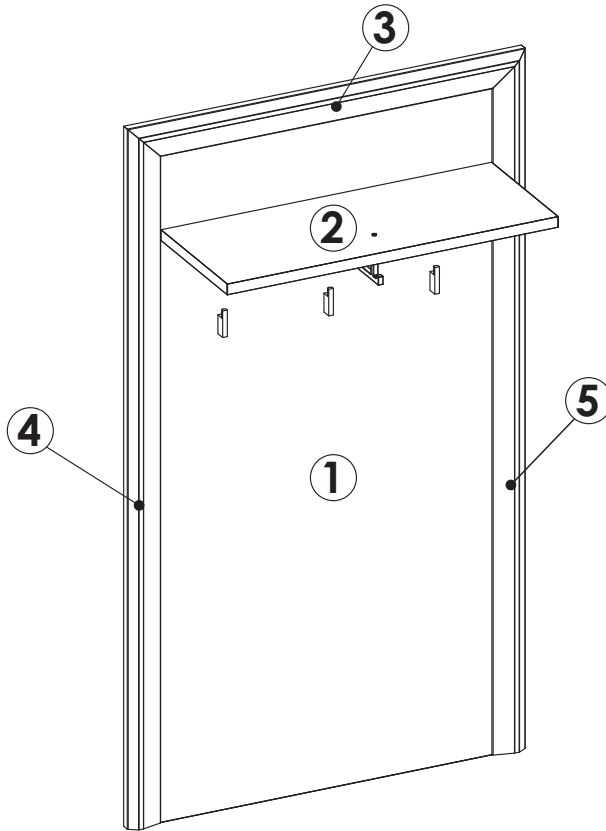

④ - C1

⑤ - C1

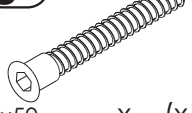
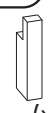
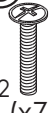
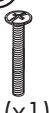
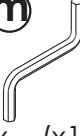

KASHMIR KAG02

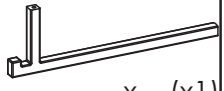

a1  8x35 x....(x4)	c2  Euro 5x13 x....(x4)	e0  x... (x20)	e1  x... (x20)	f3  7x62 x... (x10)	g0  x....(x4)			
g1  7x50 x....(x4)	h4  x....(x3)	k3  4x22 x....(x7)	k8  4x35 x....(x1)	m  x....(x1)	n1  3x16 x... (x10)	q8  x....(x2)	p1  x....(x2)	p26  x....(x1)

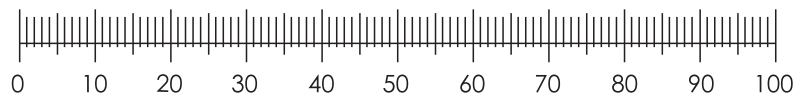
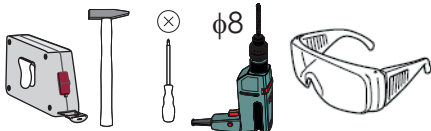

1

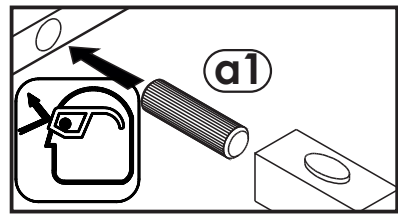
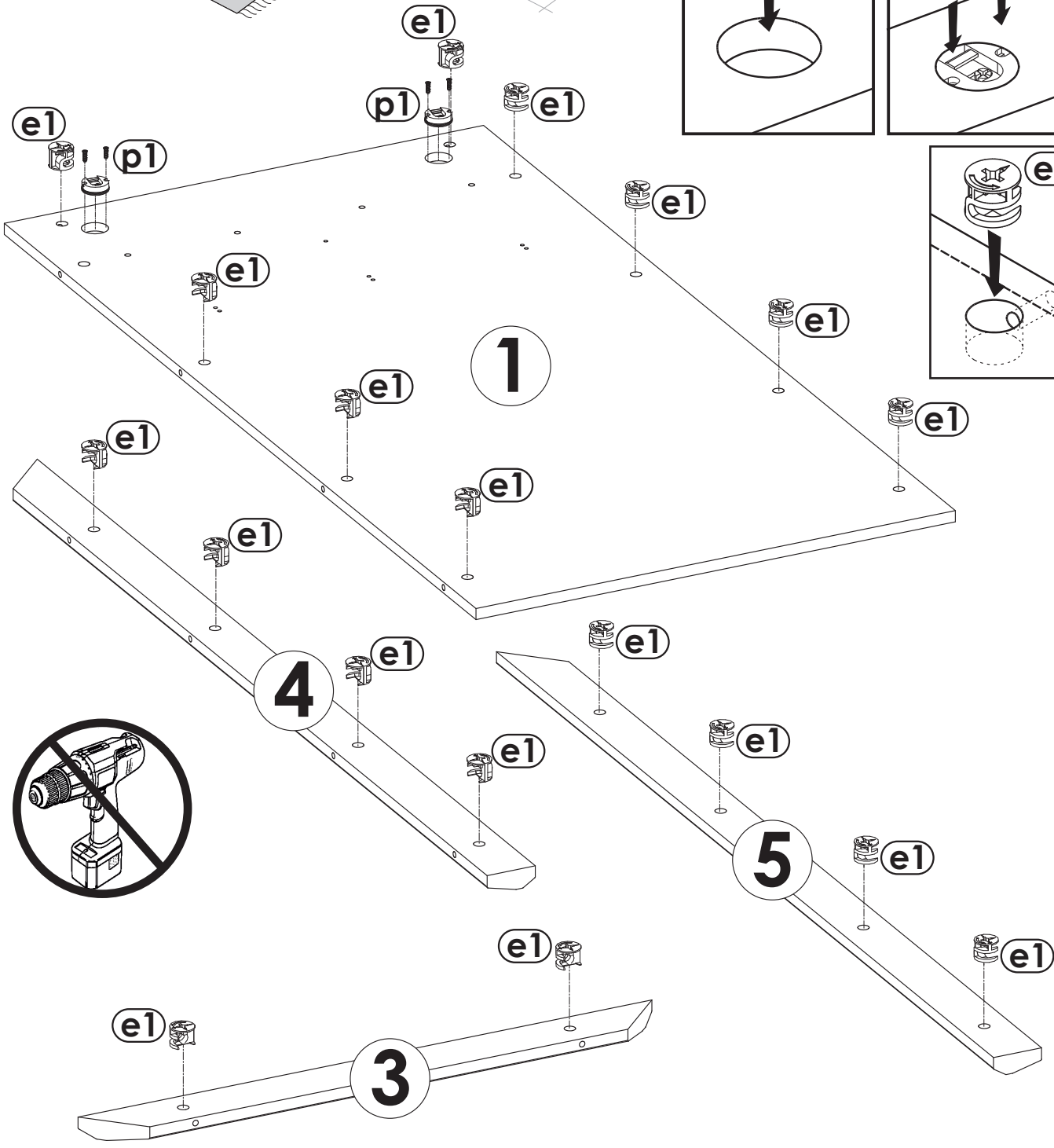
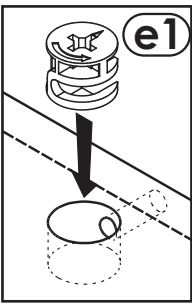
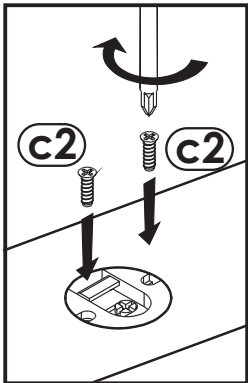
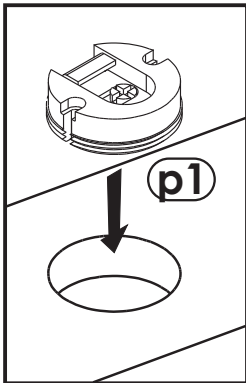
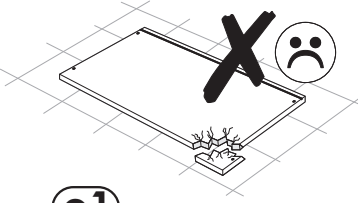
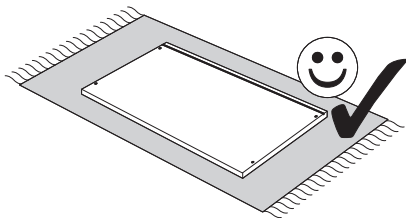

2

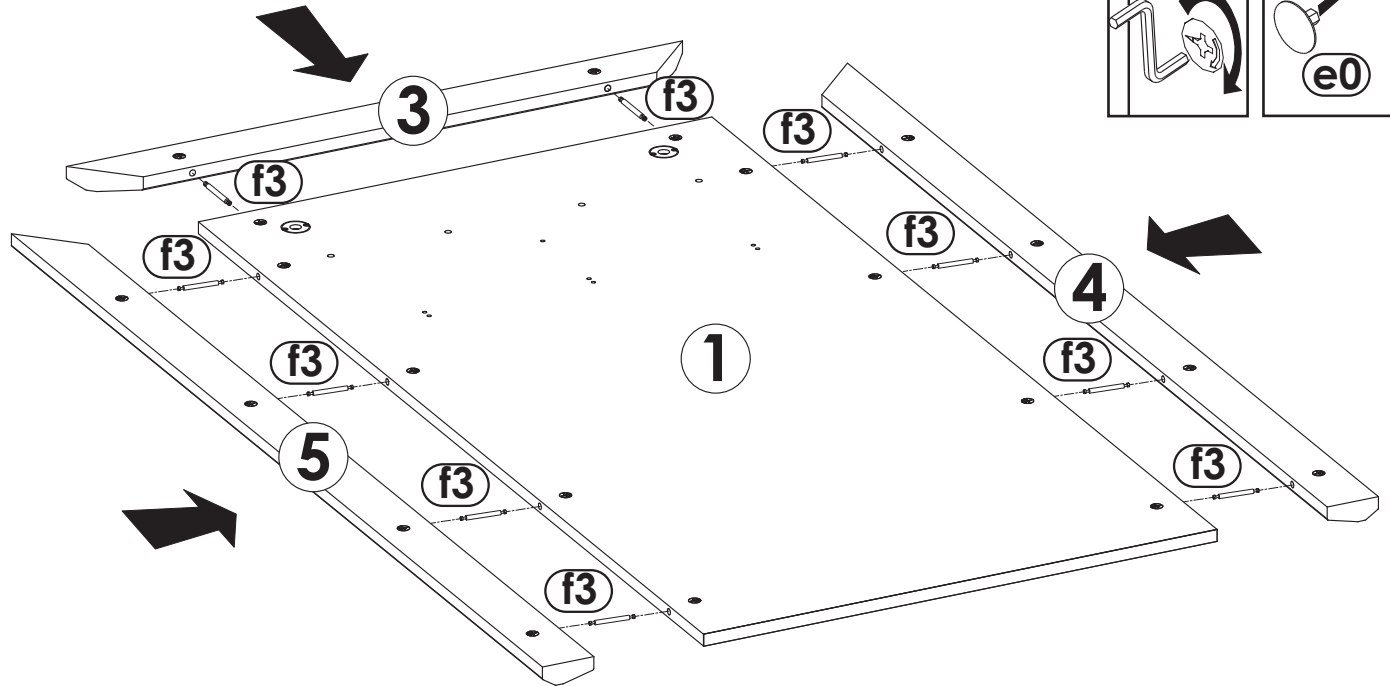
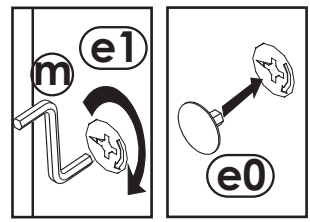
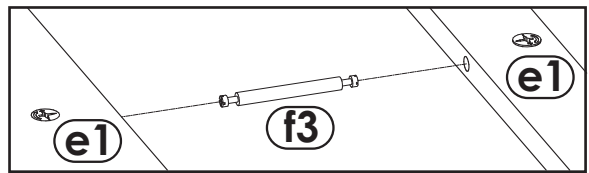
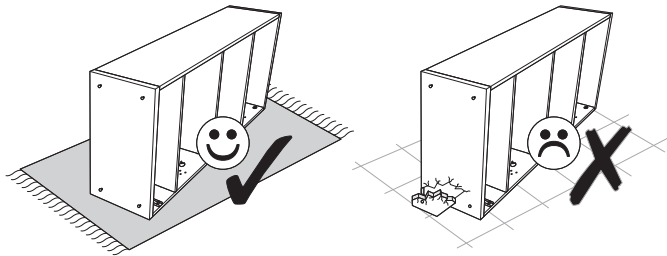

3

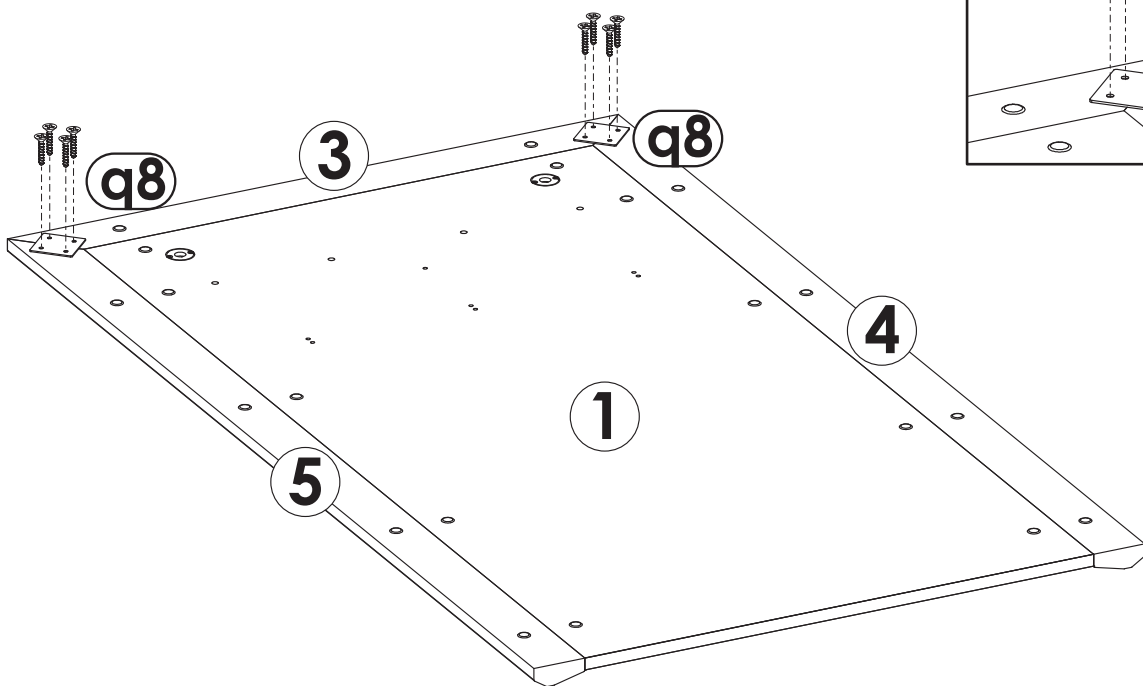
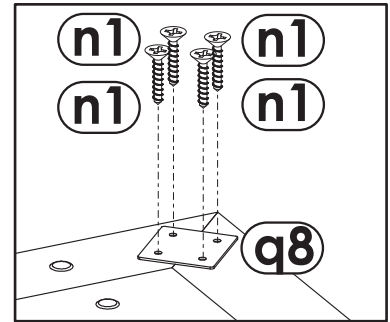
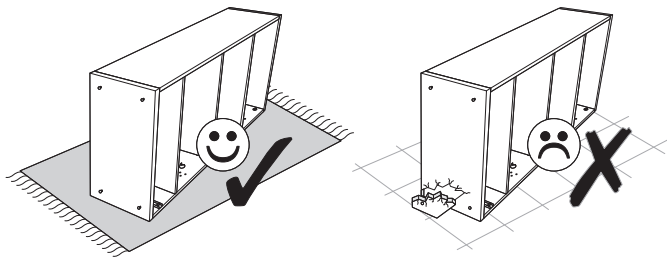

4
▼

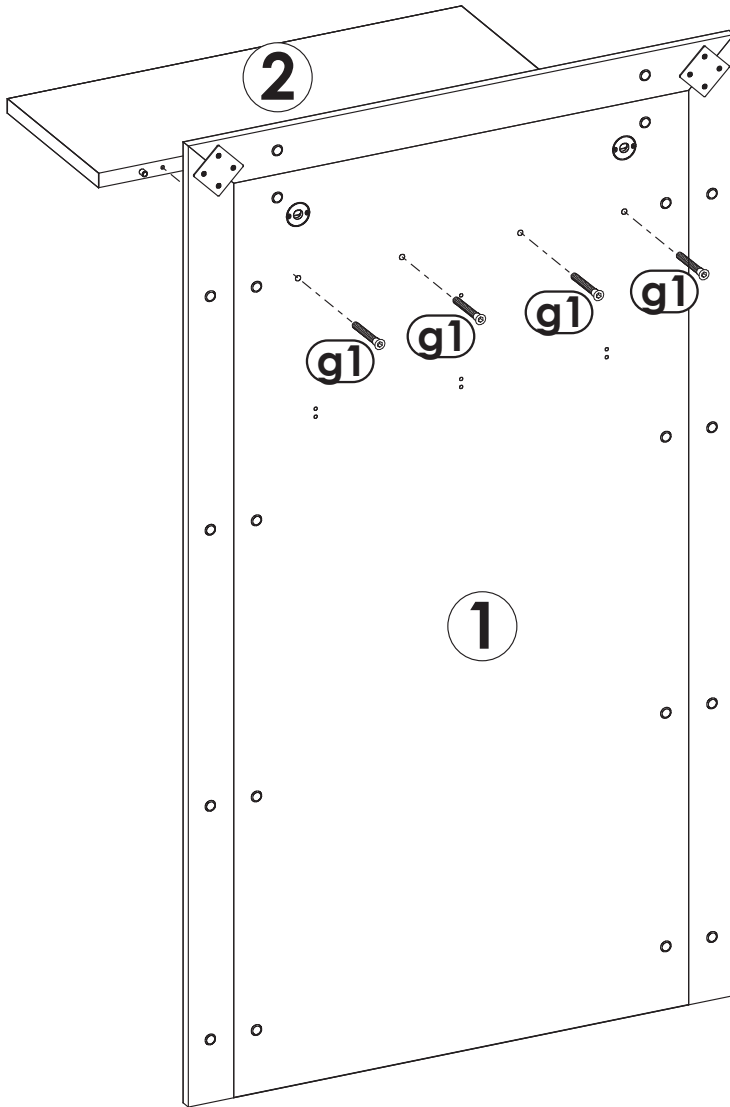
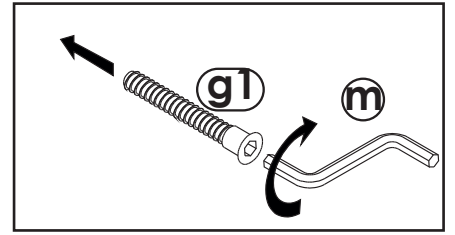
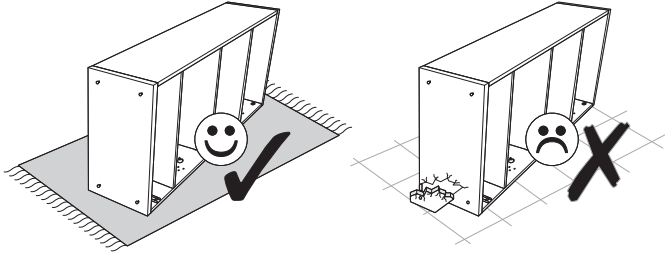

5

