

# MURA I HS

Art. Nr.= 07800004/03

Kontrolle:

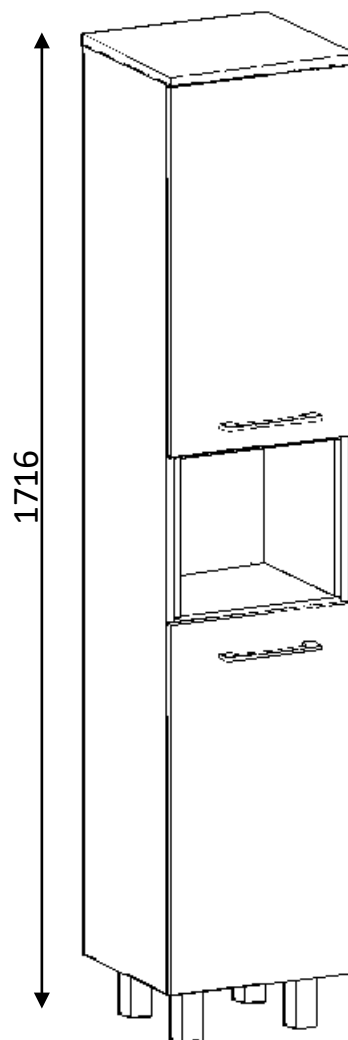
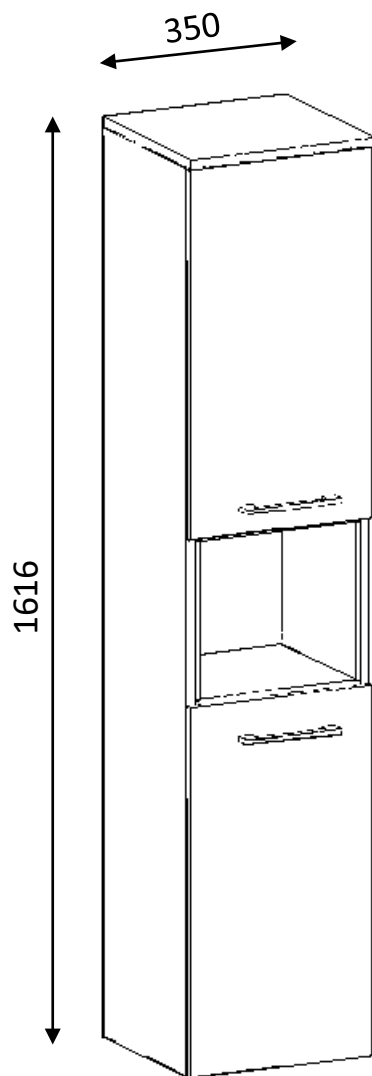
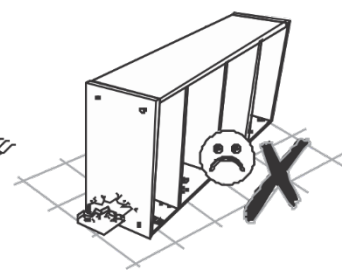
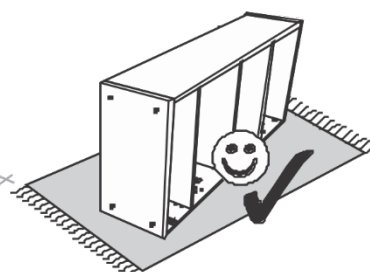
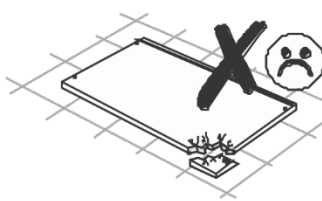
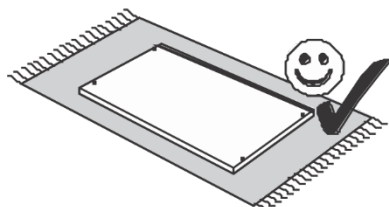
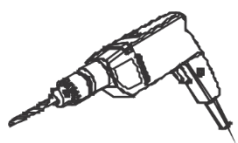
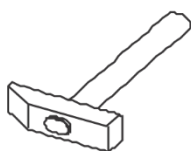
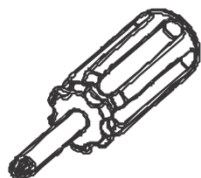
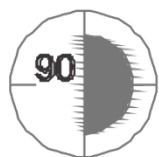

L/R

A

B

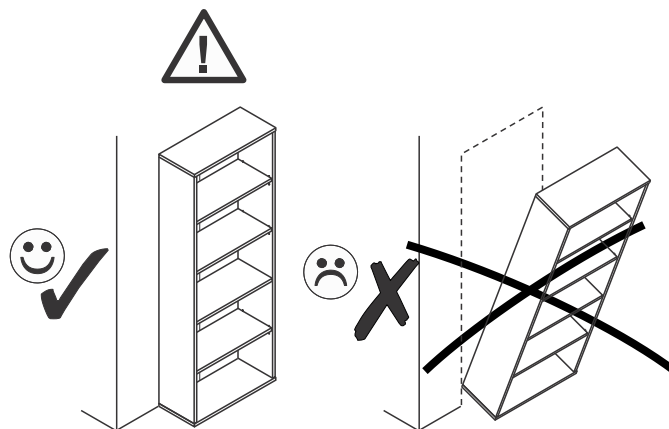

PL.  
**UWAGA!** Mebel należy trwale zamocować do ściany, aby uniknąć ryzyka związanego z przewróceniem się mebla. W paczce znajdują się elementy mocujące odpowiednie wyłącznie do ścian betonowych lub z pełnej cegły. Jeśli Twoja ściana wykonana jest z innego materiału lub nie masz pewności co do budowy tej ściany, skonsultuj się w kwestii montażu ze specjalistą.

RU.  
**ПРИМЕЧАНИЕ!** Эту мебель необходимо всегда прикреплять к стене, чтобы избежать рисков, связанных с переворотом мебели. В пакете находятся крепительные элементы, которые подходят исключительно к бетонным стенам или из целого кирпича. Если стена изготовлена из другого материала или Вы не уверены относительно строения стены, проконсультируйтесь относительно монтажа со специалистом.

I.  
**ATTENZIONE!** Il mobile deve essere permanentemente fissato alla parete per evitare i rischi derivanti da un ribaltamento del mobile. La confezione contiene solo elementi di fissaggio adatti per pareti in calcestruzzo o in laterizio pieno. Se la vostra parete è realizzata in materiale diverso o avete dubbi sulla costruzione della parete, consultare uno specialista per un montaggio corretto.

SI.  
**POZOR!** Element je treba zanesljivo pritrditi a steno, da se prepreči nevarnost prevrnitve. Komplet vsebuje pritrdilne elemente, ki so namenjene izključno za betonske stene oz. stene s polne opeke. Če je vaša stena izdelana iz drugega materiala, oz. niste prepričani glede uporabljenega gradbenega materiala, pred začetkom montaže obrnite se na strokovnjake.

EN.  
**WARNING!** To prevent this furniture from tripping over, fix it to the wall permanently. The package includes fastening elements only suitable for concrete or full-brick walls. If your wall is made of a different material or you are unsure as to the construction of the wall, please consult a specialist regarding installation.

FR.  
**ATTENTION!** Ce meuble doit être fixé en permanence au mur pour éviter les risques de chute. L'ensemble comprend des moyens de fixation adaptés uniquement aux murs de béton ou de brique. Si votre mur est fait d'un matériau différent ou si vous êtes incertain quant à la construction du mur, consultez un spécialiste.

HR.  
**NAPOMENA!** Namještaj mora biti trajno pričvršćen za zid, kako bi se izbjegao rizik od njegova prevrtanja. U paketu se nalaze elementi za pričvršćivanje prikladni isključivo za betonske zidove ili punu ciglu. Ako je Vaš zid izrađen od drugog materijala ili niste sigurni od čega je napravljen Vaš zid, konzultirajte se sa stručnjakom u vezi sa montažom.

CZ.  
**POZOR!** Nábytek je nutné pevně připevnit ke zdi, abychom se vyhnuli riziku spojenému s jeho převrnutím. V balíčku se nacházejí připevňující prvky vhodné výhradně do betonových zdí nebo zdí z plných cihel. Pokud jsou Vaše zdi zhotoveny z jiného materiálu nebo si nejste jejich konstrukci jisti, konzultujte otázku montáže se specialistou.

D.  
**ACHTUNG!** Um alle mit dem Umkippen des Möbels verbundenen Risiken auszuschließen, muss das Möbel fest an der Wand verankert werden. Die im Paket enthaltenen Beschläge für die Wandbefestigung sind ausschließlich für Wände aus Beton oder Vollziegeln geeignet. Sollten die heimischen Wände aus anderem Baumaterial bestehen oder sollte es Zweifel in Hinsicht auf dieses Baumaterial geben, bitte eine Fachkraft zu Rate ziehen.







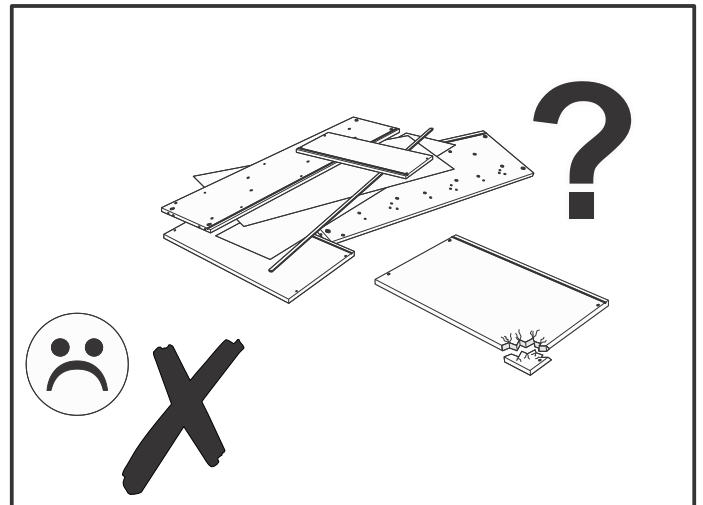
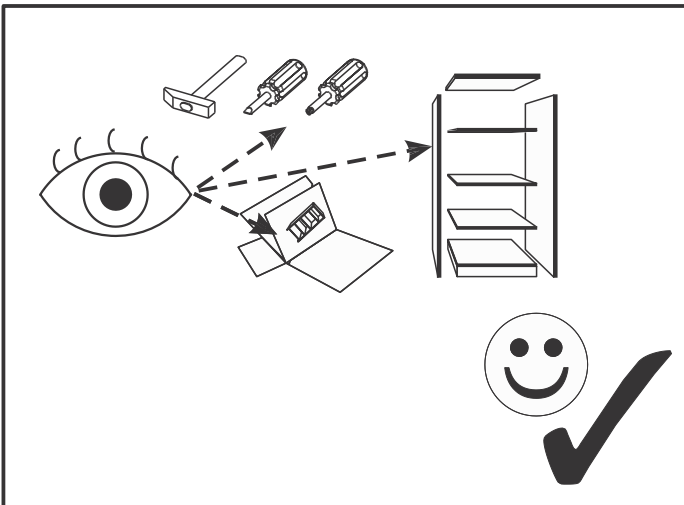
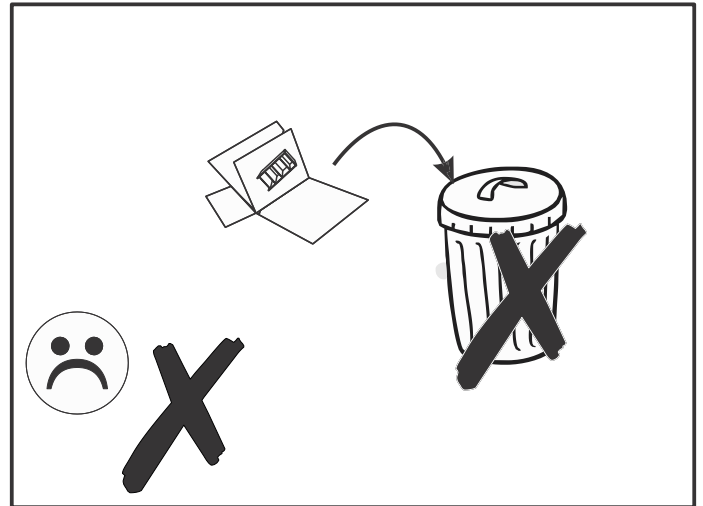
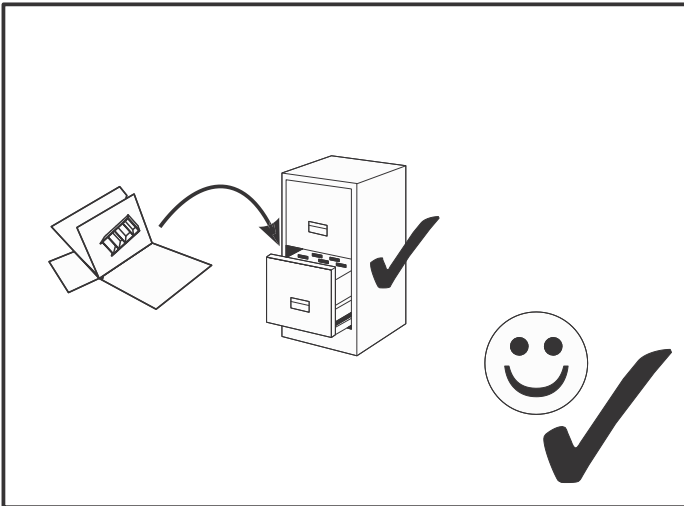
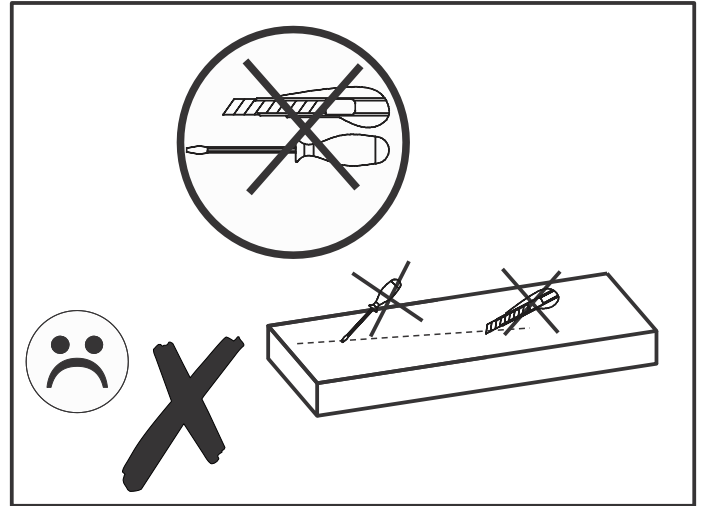
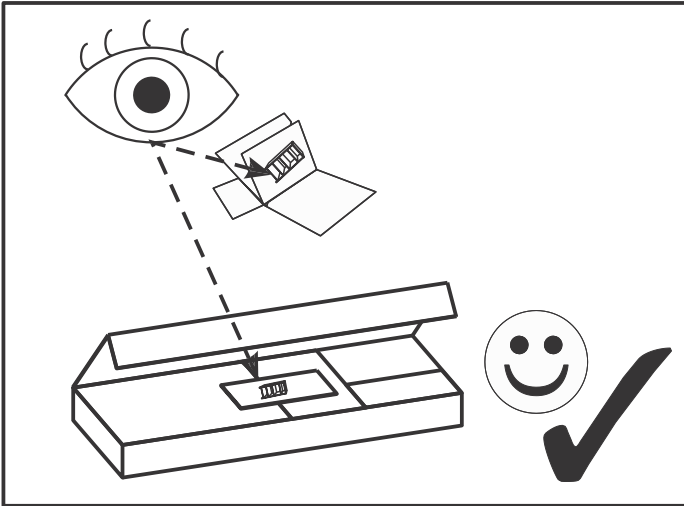



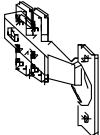
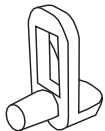
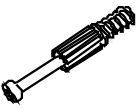

HU.  
**FIGYELEM!** Rögzítse a bútorkat a falhoz, hogy elkerülje a bútor felborulásának kockázatát. A készletben kizárólag beton- vagy téglafalhoz használható kötőelemek találhatók. Ha a fal más anyagból készült, vagy ha nem tudja, milyen falak találhatók otthonában, forduljon szakemberhez.

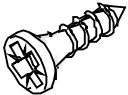
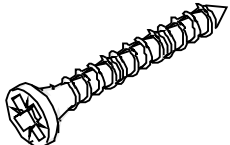
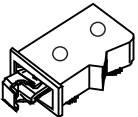
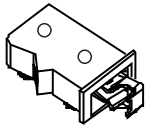
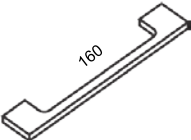
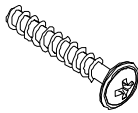
SK.  
**POZOR!** Nábytok musí byť trvalo pripevnený k stene tak, aby sa zamedzilo riziku prevrátenia. V balíku sa nachádzajú upevňovacie komponenty výlučne pre betónové steny alebo steny z plnej tehly. Ak je Vaša stena z iného materiálu alebo ak si nie ste istí, z čoho je stena vyhotovená, vyžiadajte si odbornú pomoc.

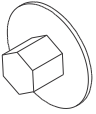
E.  
**¡ATENCIÓN!** El mueble debe ser fijado permanentemente a la pared para evitar el riesgo relacionado con el vuelco del mueble. En el paquete hay elementos de fijación adecuados solo para paredes de hormigón o de ladrillo entero. Si su pared está hecha de otro material o no está seguro sobre la construcción de esta pared, consulte el montaje con un especialista.

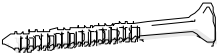

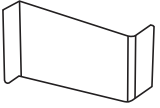
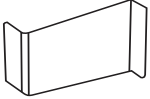
# MURA I HS

<b>A1</b> 8x30  x16	<b>A2</b> 6x30  x24	<b>B1</b>  x4
<b>C1</b>  x8	<b>D2</b> 5x35  x16	<b>D3</b> 15x12  x16
<b>F3</b> 4x16  x40	<b>F7</b> 4x30  x4	<b>G3</b>  x1
<b>G4</b>  x1	<b>H1</b> 160  x2	<b>I1</b> 4x20  x4
<b>K1</b>  x9	<b>M1</b>  x16	<b>N1</b>  x4
<b>O2</b>  x2	<b>P1</b> 5x70  x4	<b>R1</b>  x4
<b>T1</b>  x1	<b>T2</b>  x1	<b>S1</b>  x4

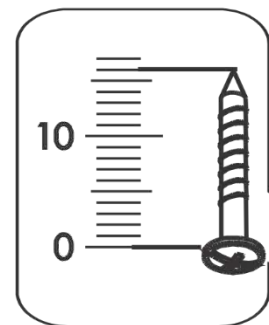
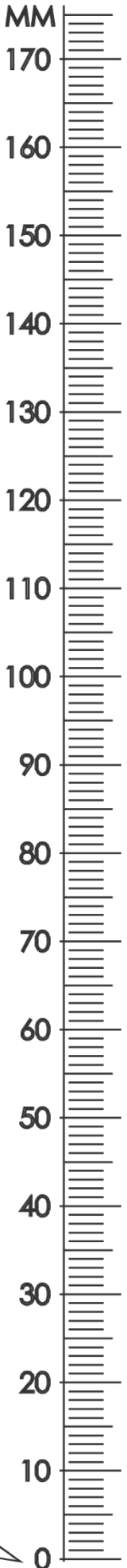

# MURA I HS

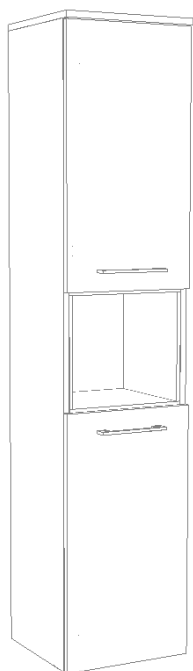

①	x1	1600x310x16
②	x1	1600x310x16
③	x2	316x287x16
④	x1	350x330x16
⑤	x2	316x287x10
⑥	x2	277x279x10
⑦	x1	316x279x10
⑧	x2	309x250x6
⑨	x1	650x346x16
⑩	x1	650x346x16
⑪	x1	1606x330x3
⑫	x1	316x287x16

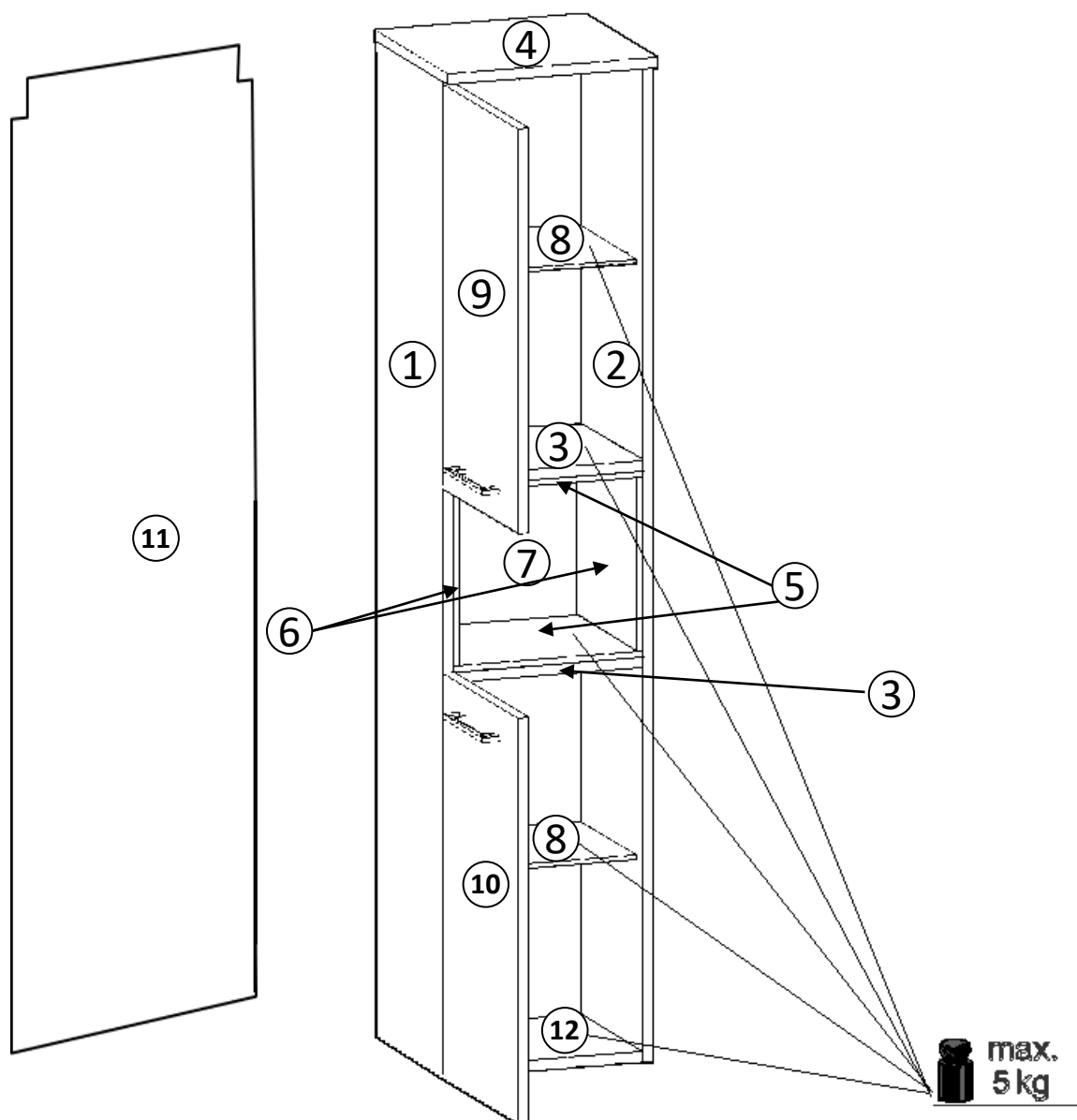
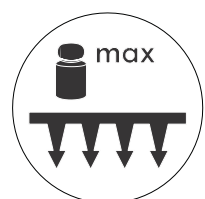

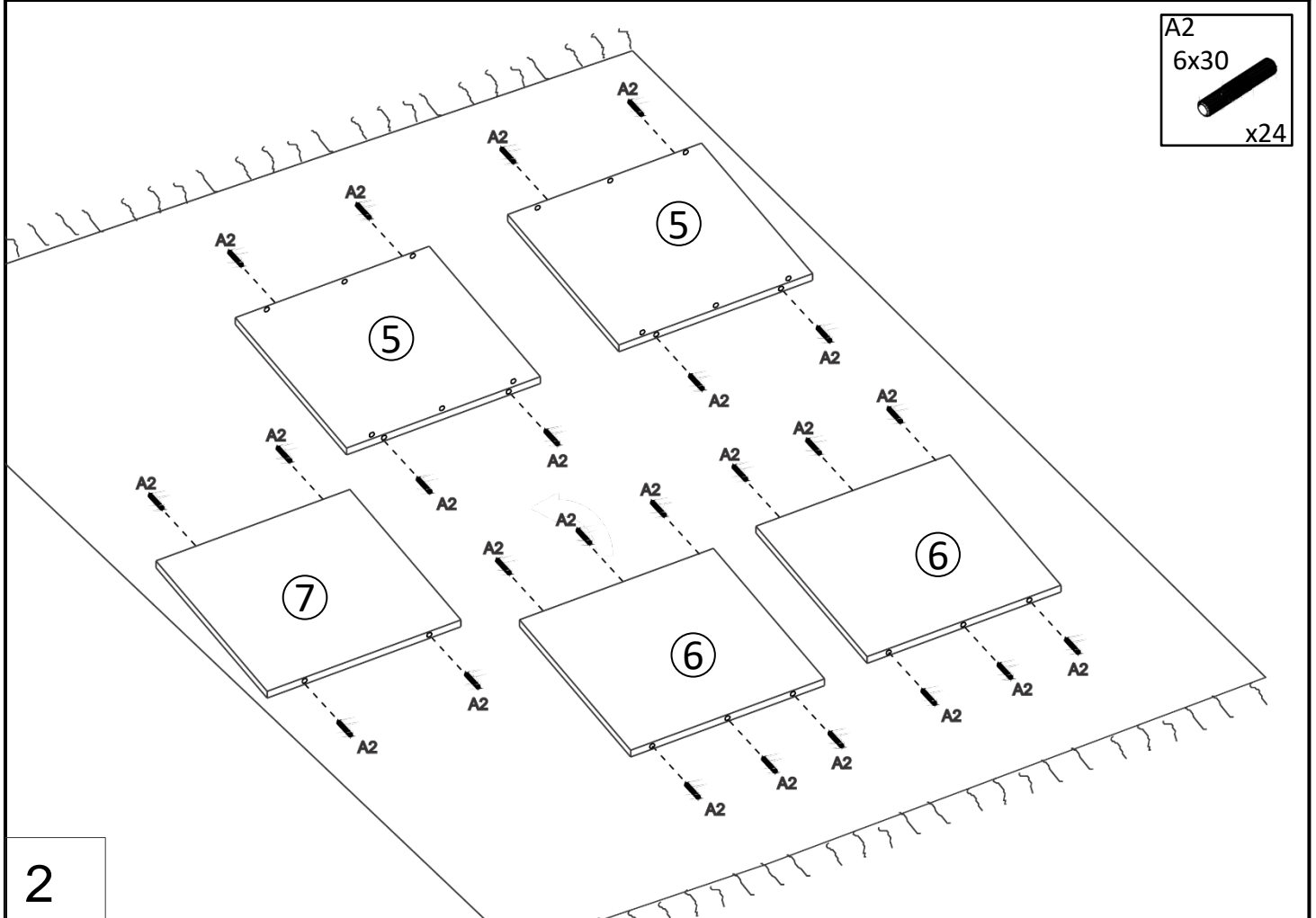
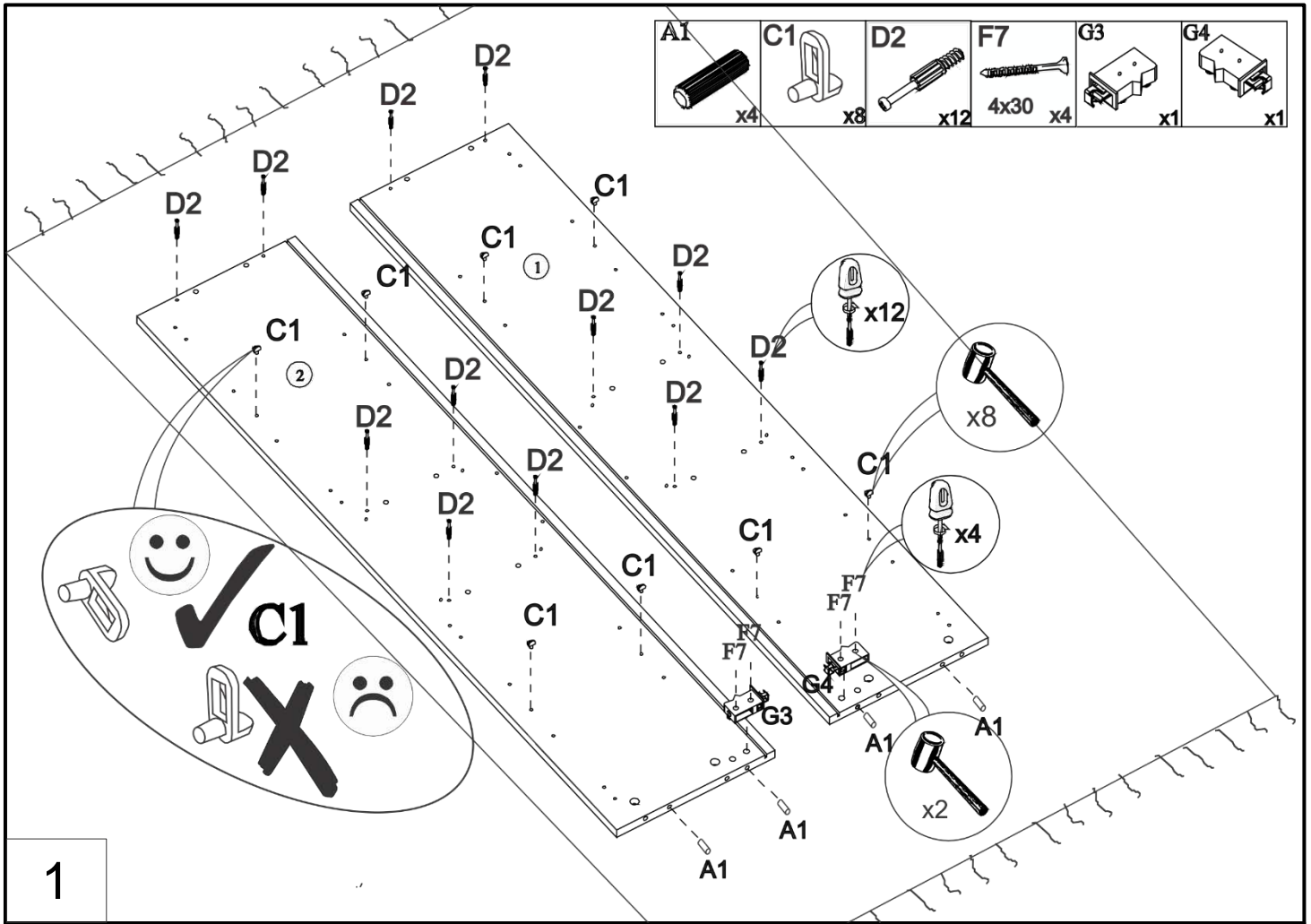

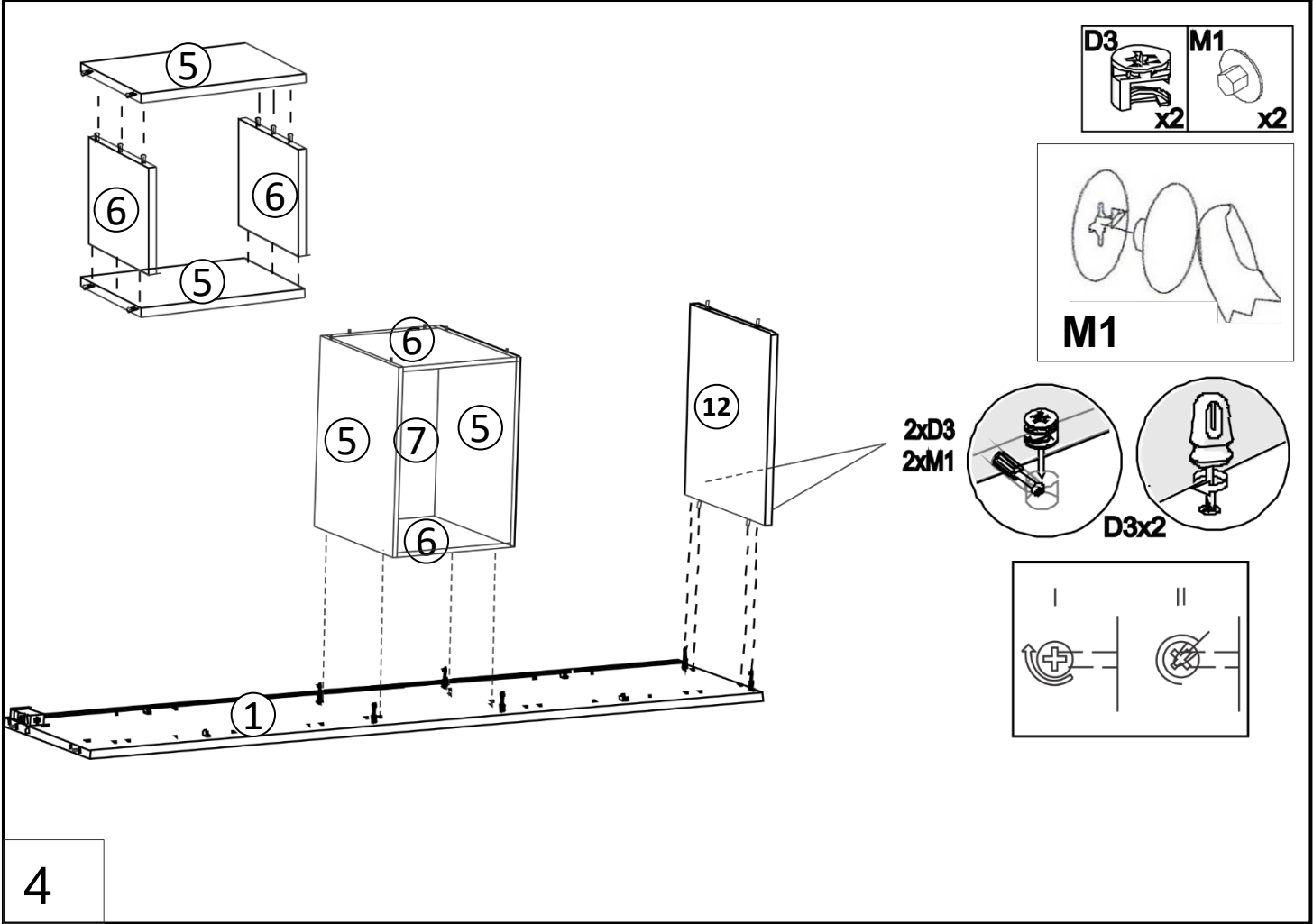
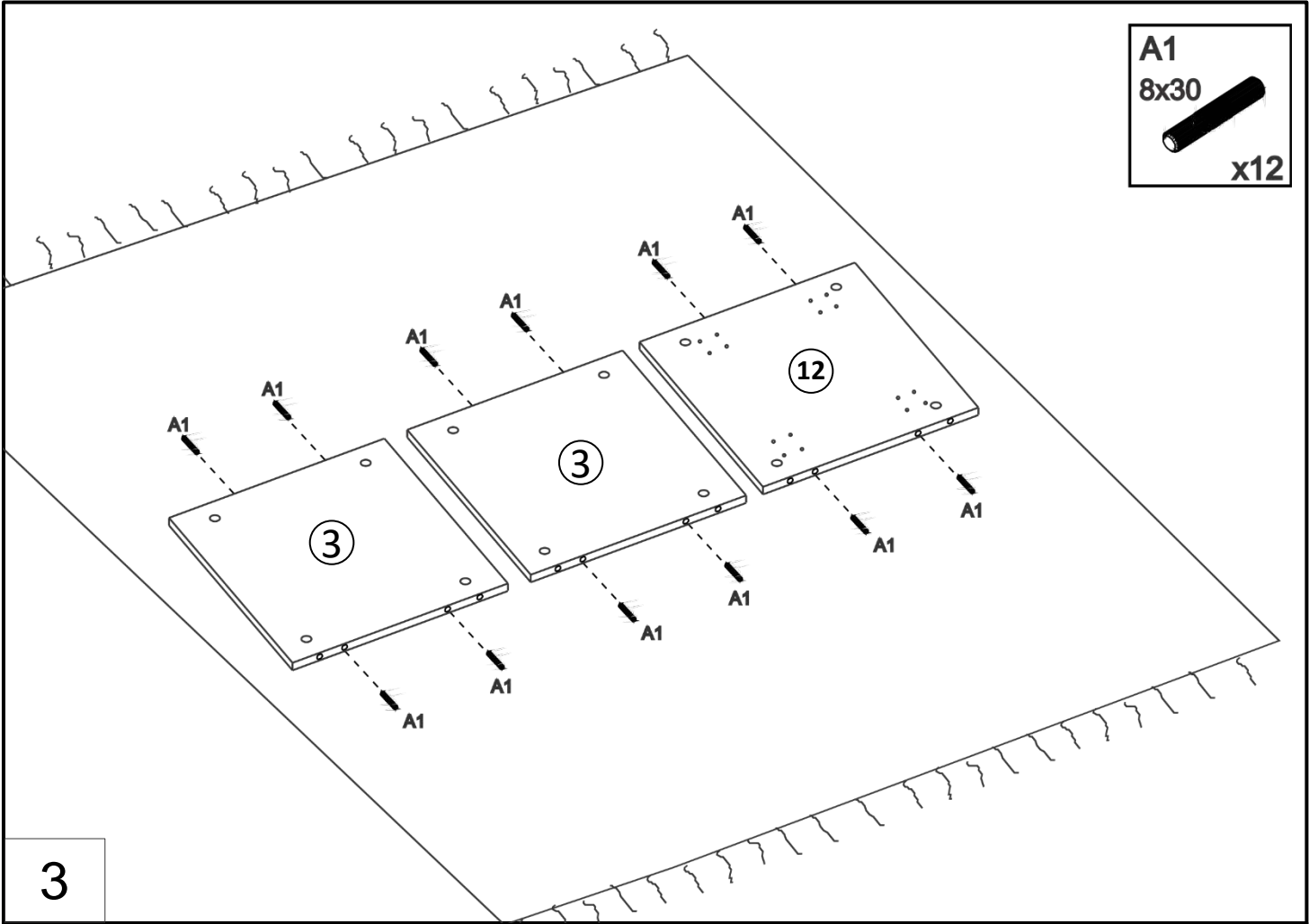

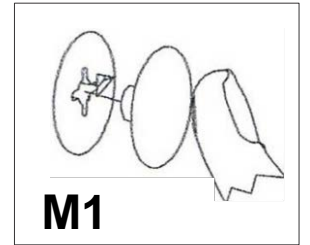
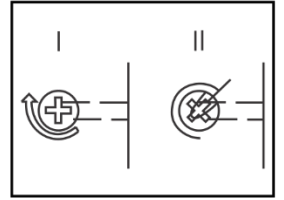
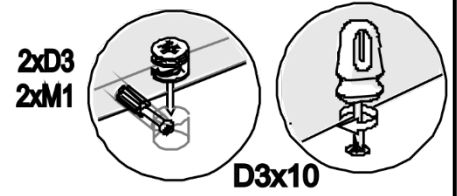
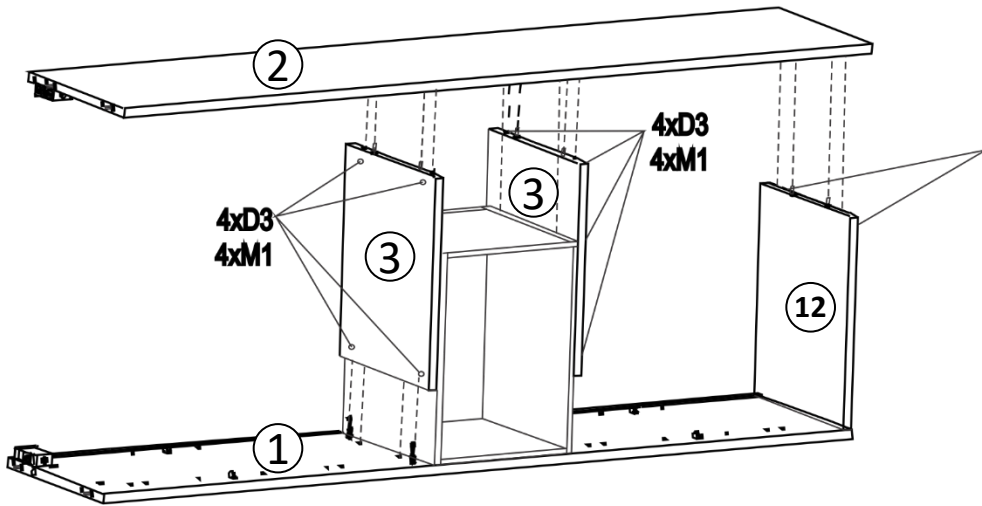
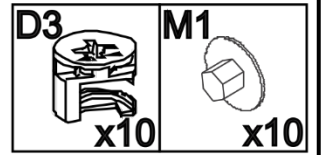

5

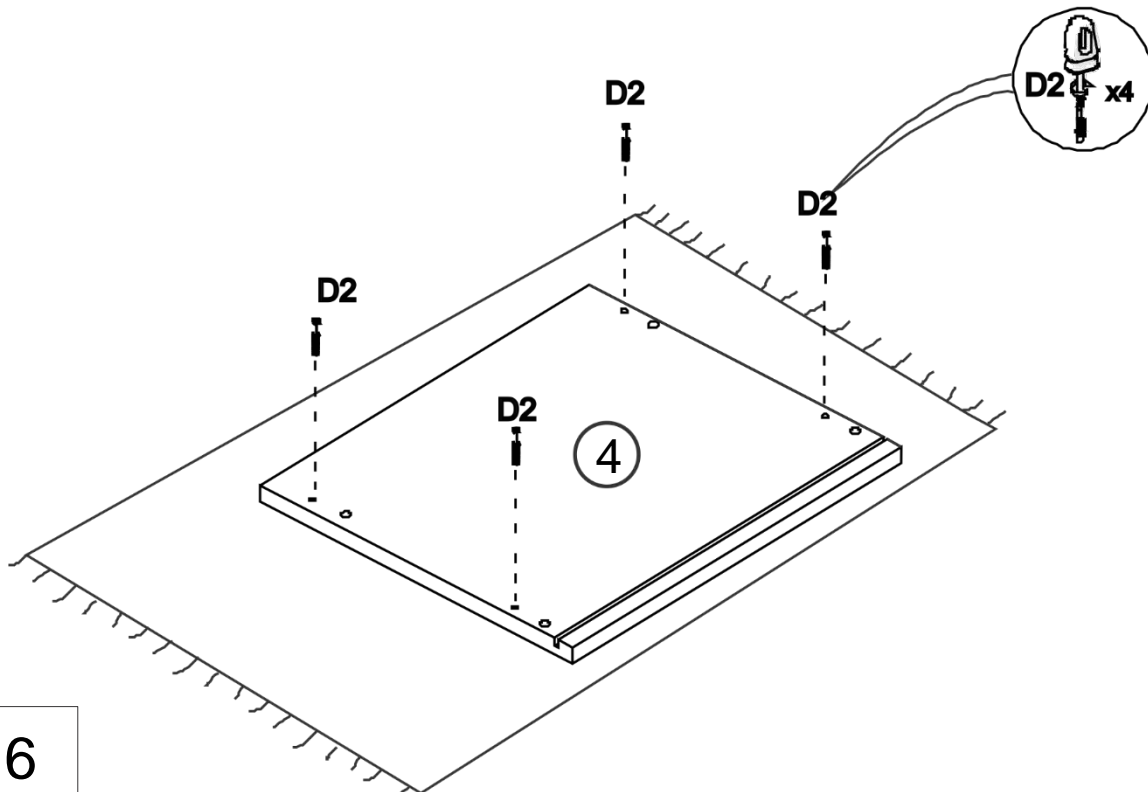

6



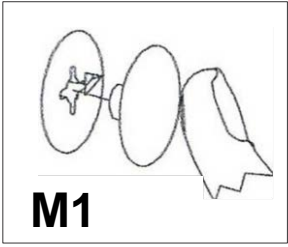
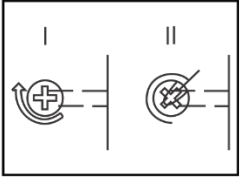
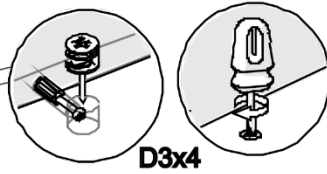
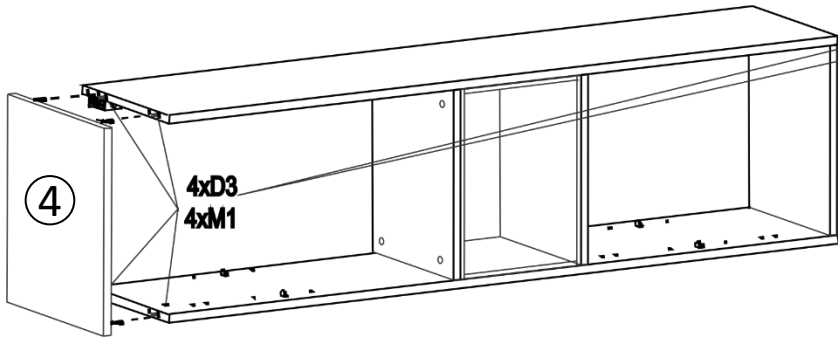
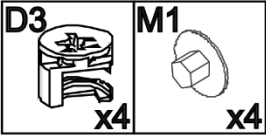

7

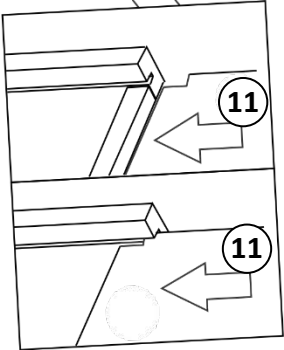
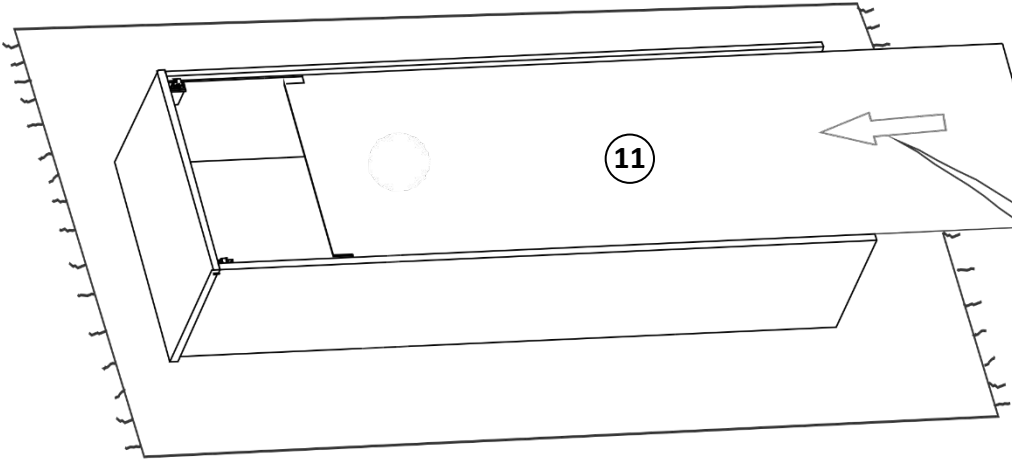

8

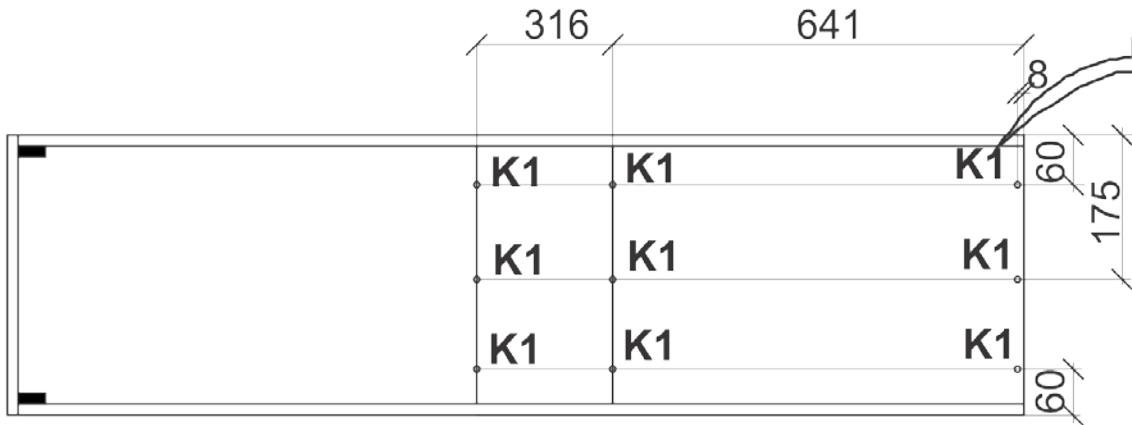
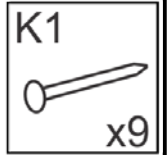
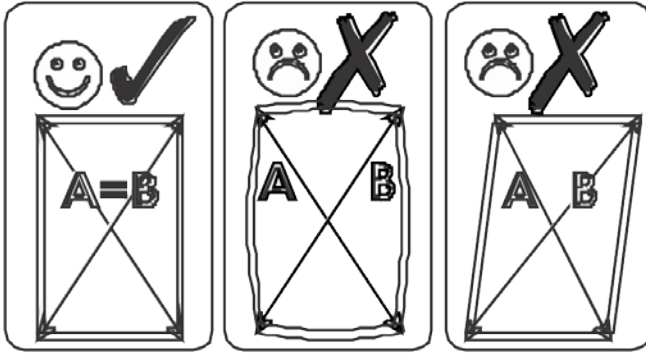

9

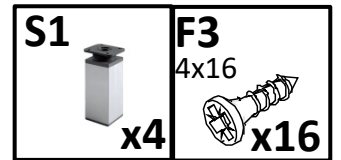

Opt B

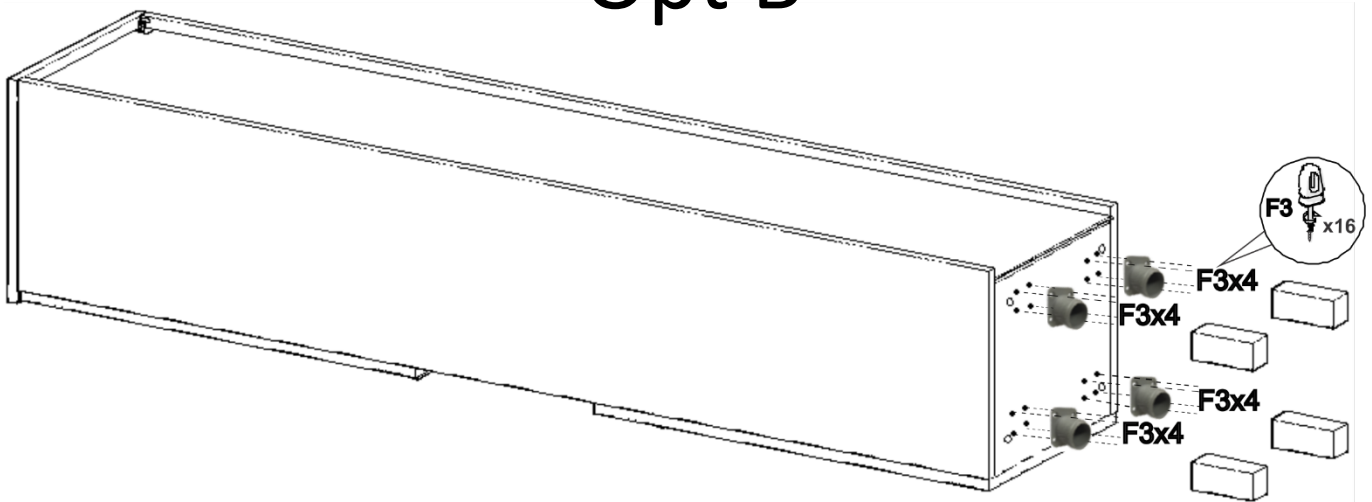

10

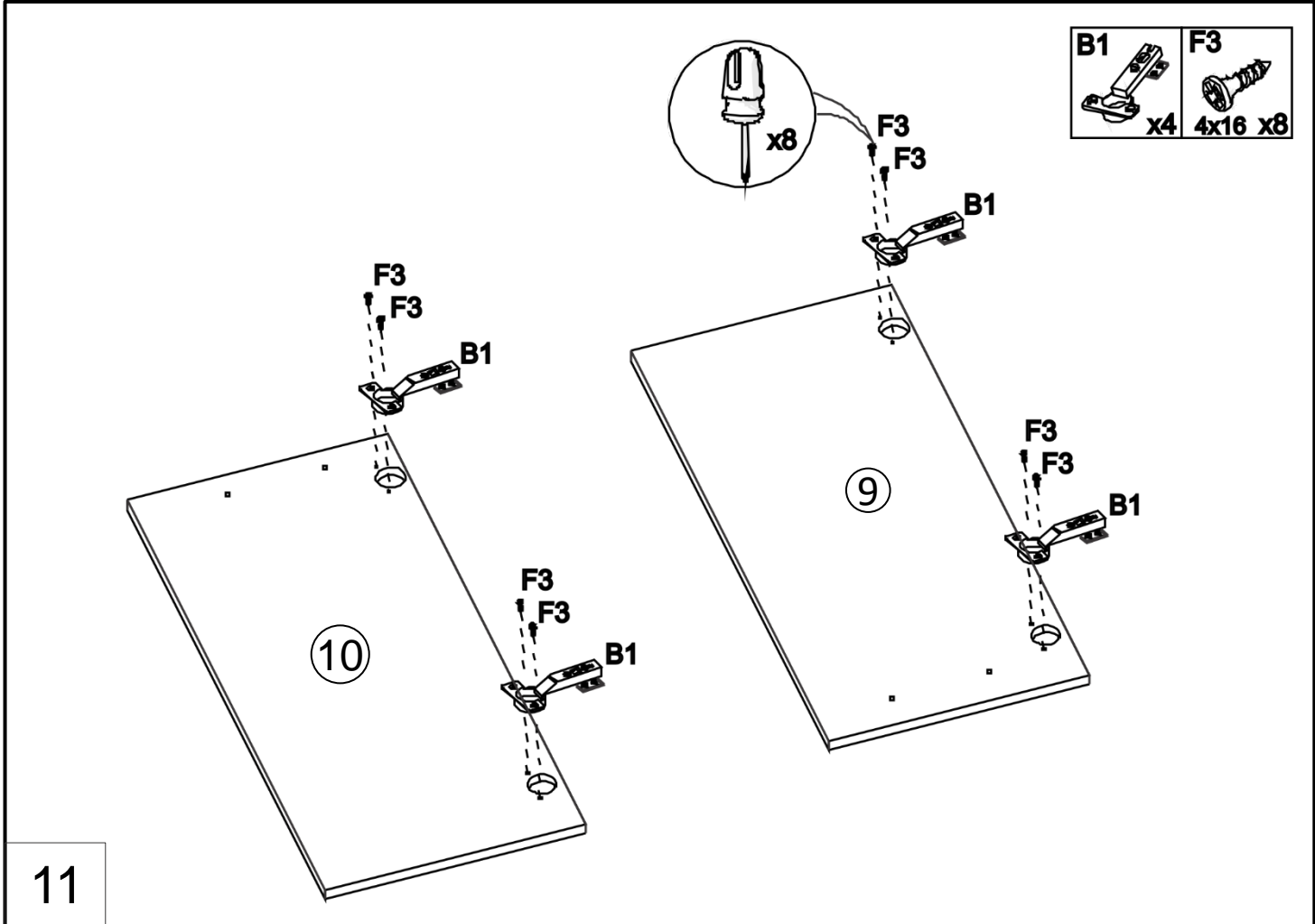

Opt L

Opt R

