

KAROL

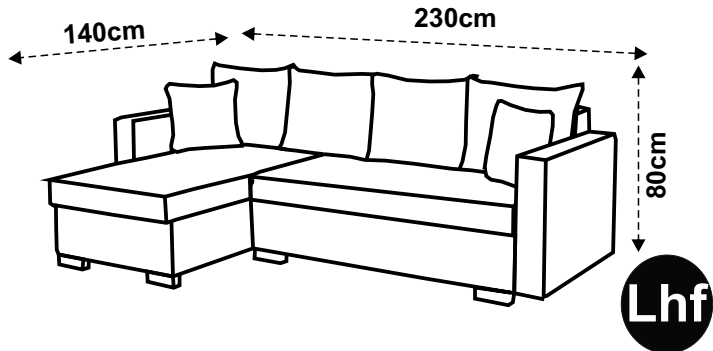

Lhf

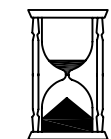

30 MIN

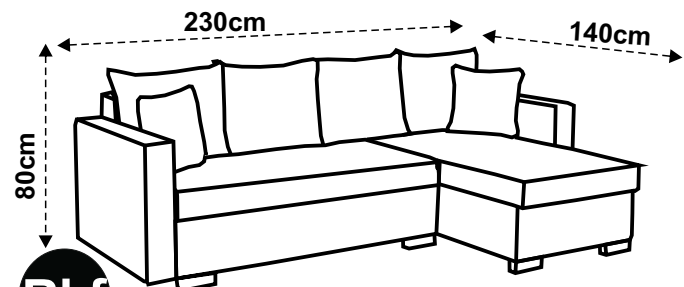
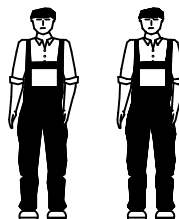

Rhf

	↙	↑	↗	PCS	📦
①	1300	650	230	x1	2/3
①a	1300	700	420	x1	2/2
①b	820	550	130	x1	3/3
①c	1300	600	130	x1	2/3
②	1250	700	420	x1	1/3
②a	820	550	130	x1	3/3
③	590	490	200	x3	2/3
③	590	490	200	x1	1/3
④	390	390	100	x2	2/3
⑤	700	670	130	x1	1/3

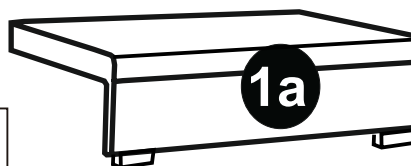
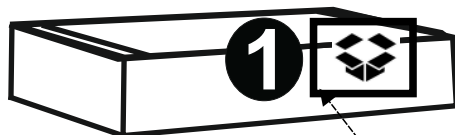
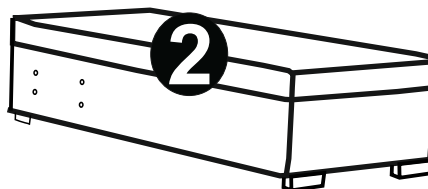
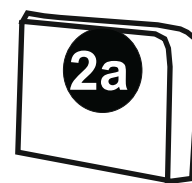
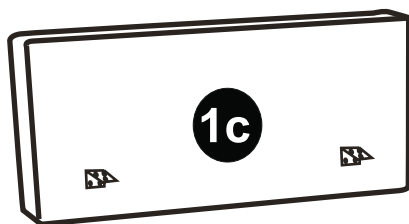
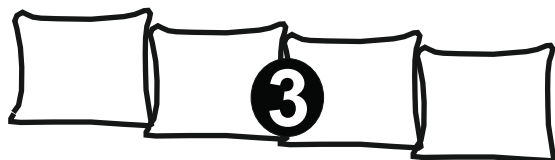
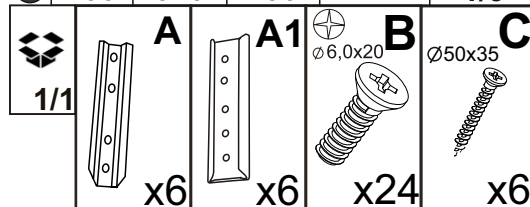
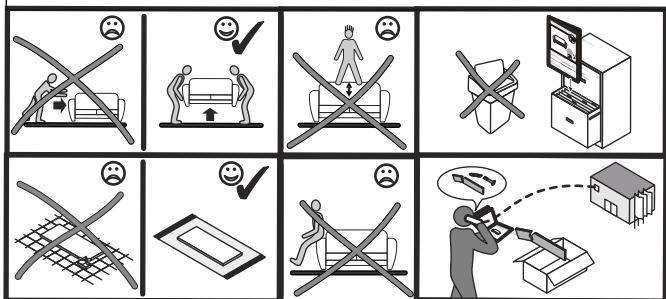

I.

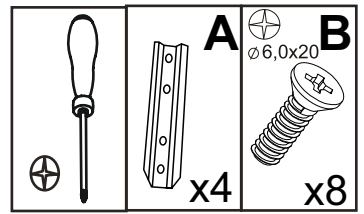
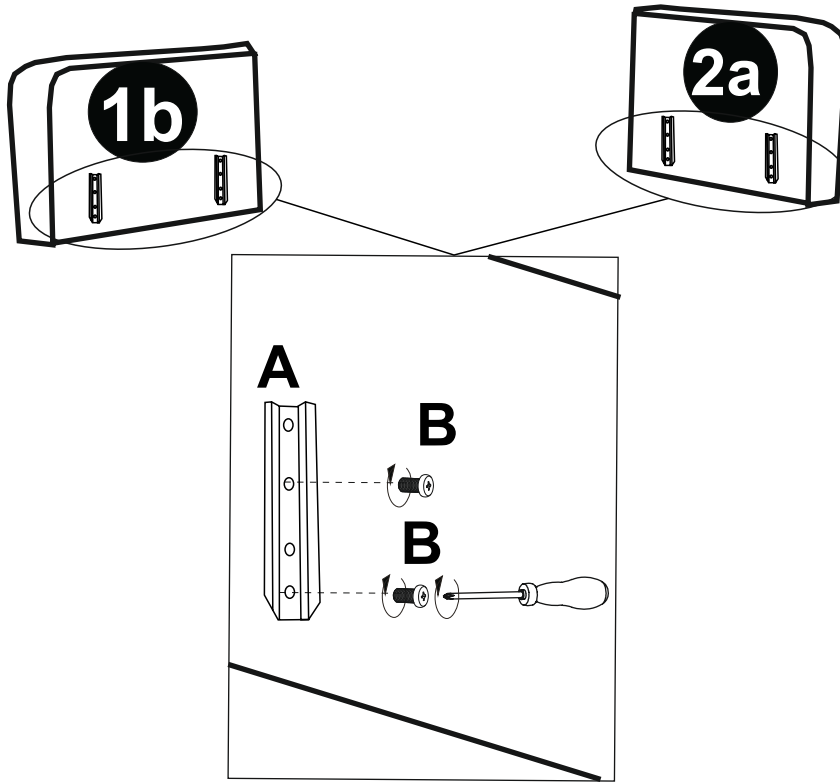

II.

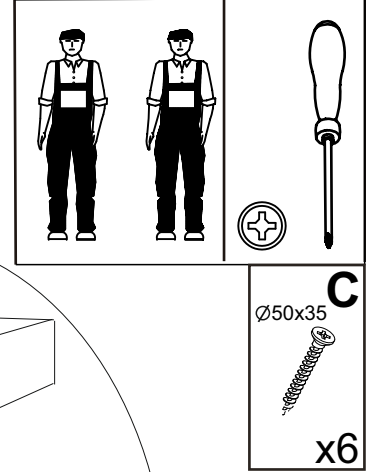
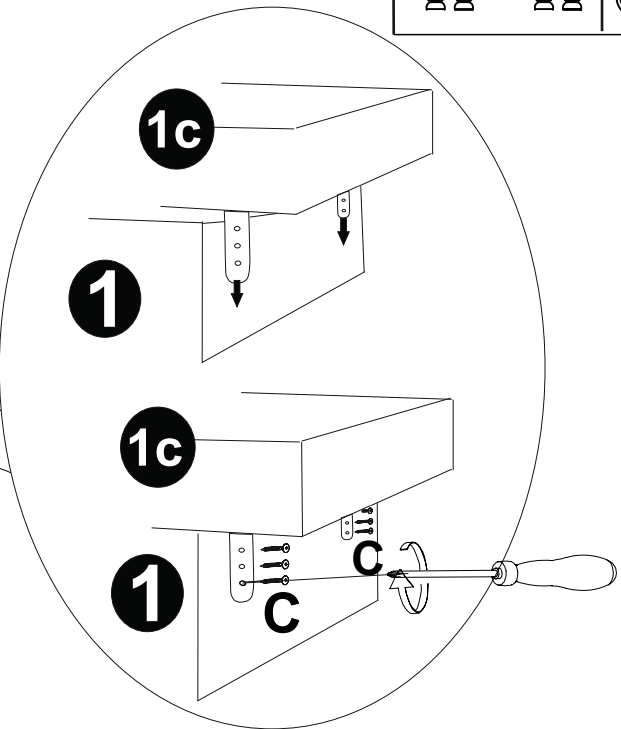
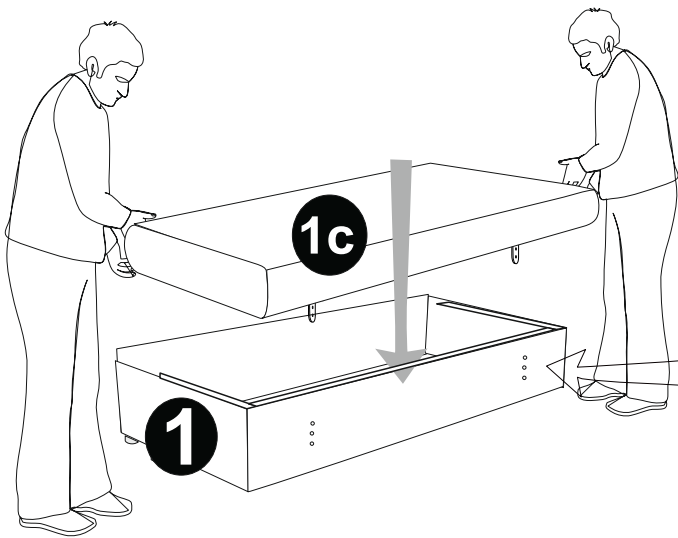

Rhf

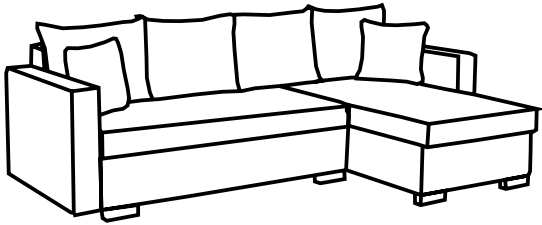

Lhf

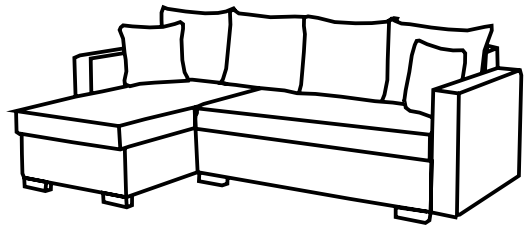

III.

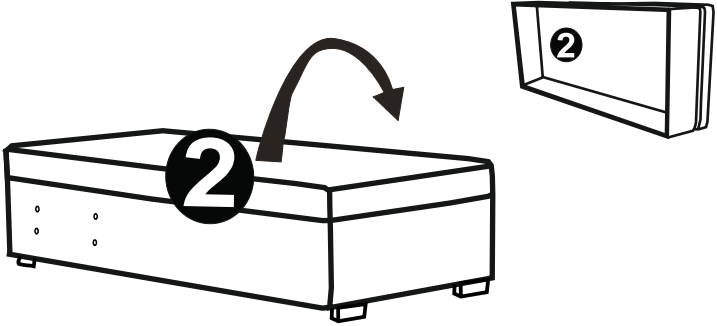

III.

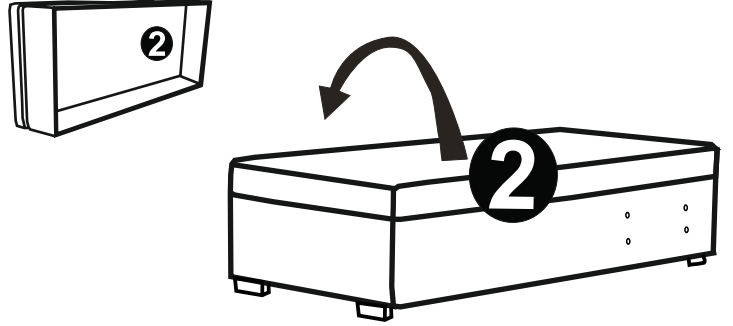

IV.

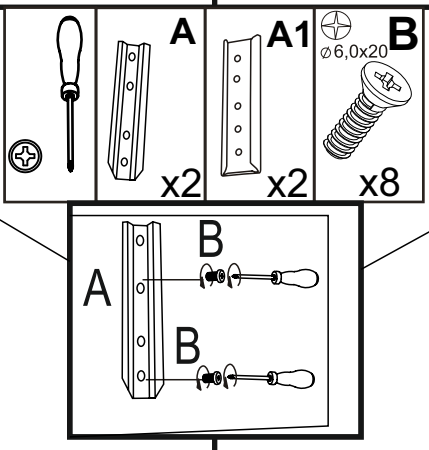
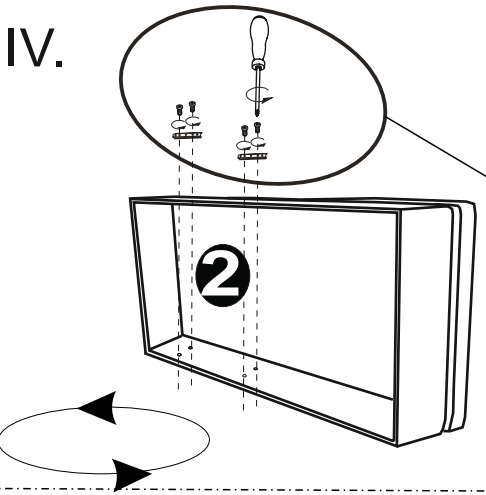

IV.

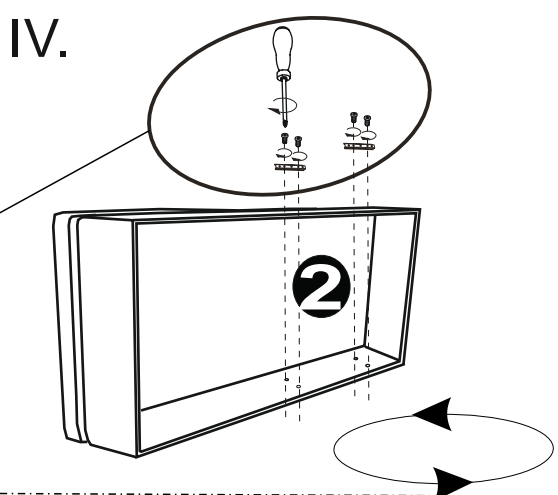

V.

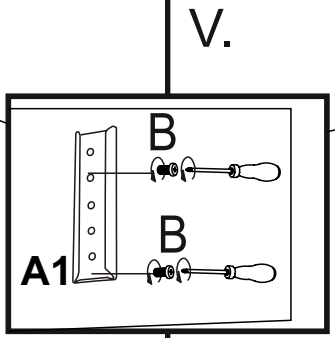
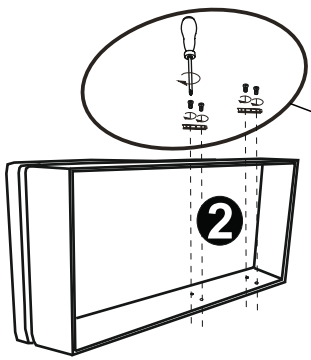

V.

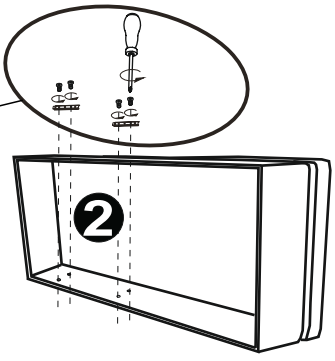

VI.

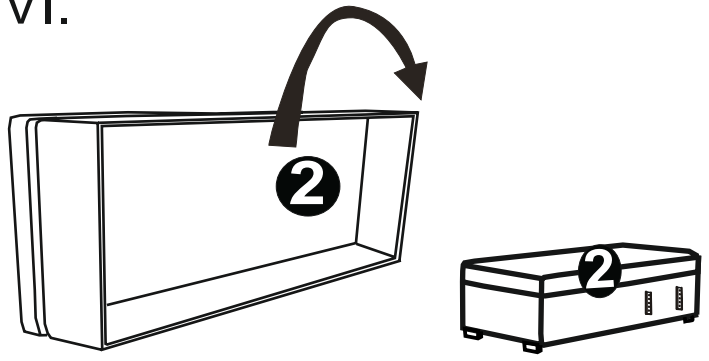

VI.

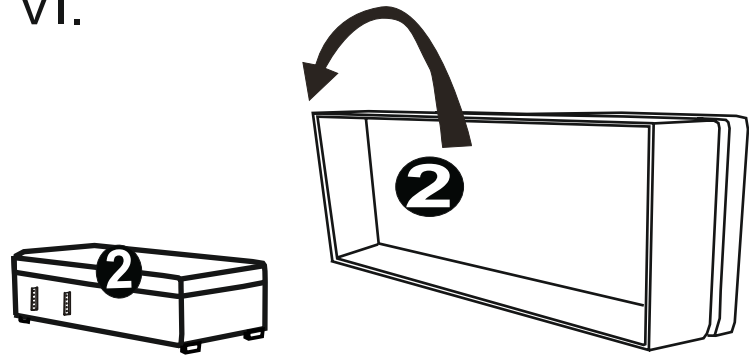

Rhf

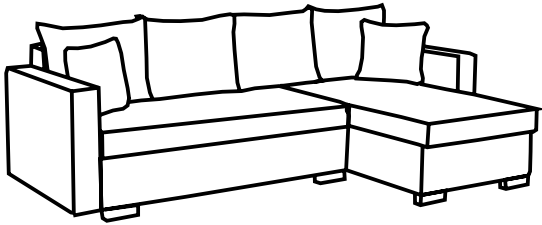

Lhf

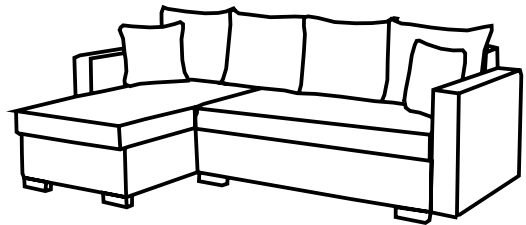

VII.

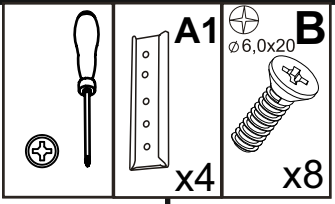
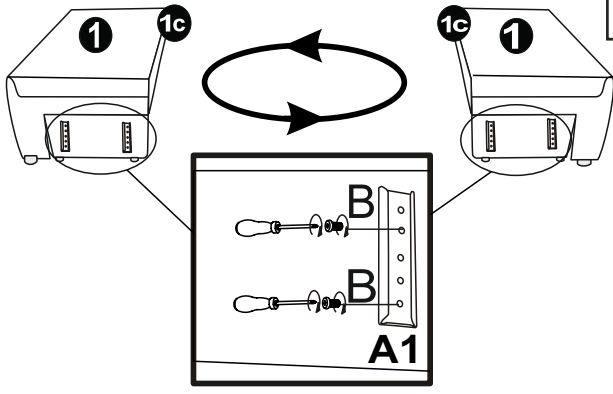

VII.

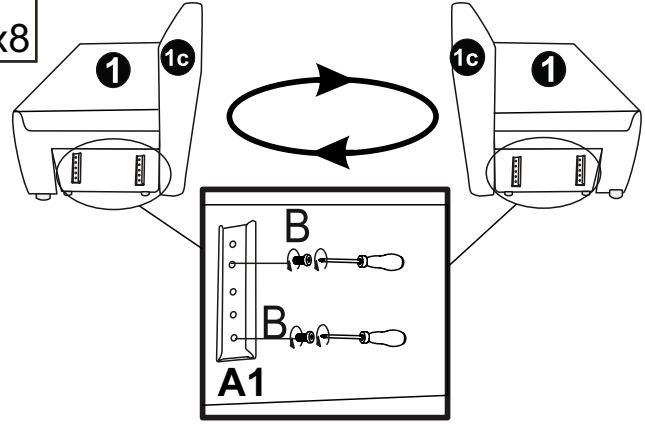

VIII.

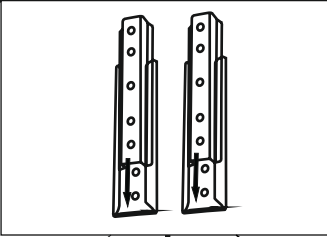
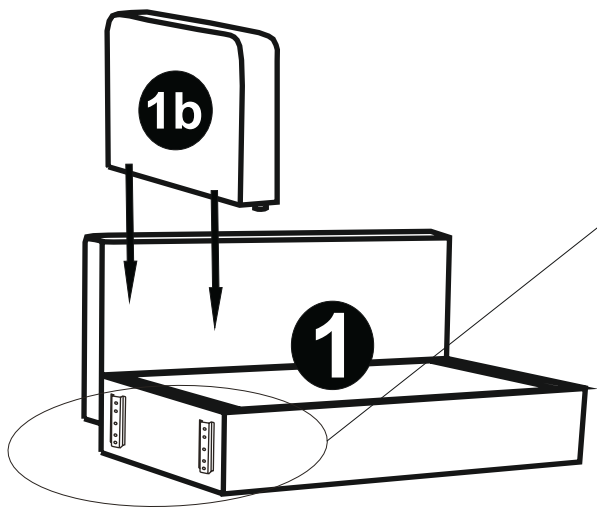

VIII.

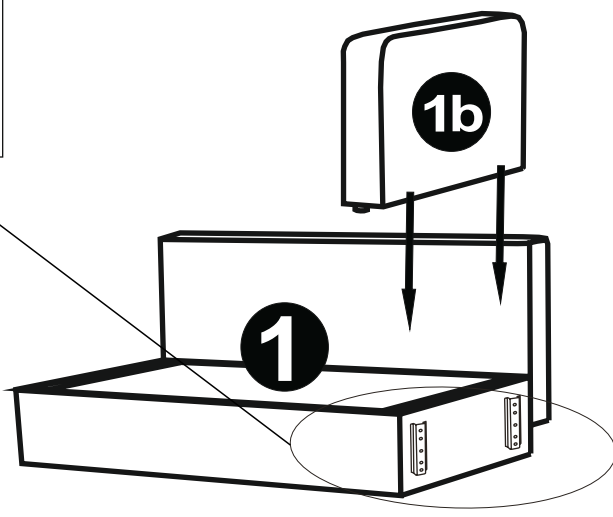

VIII.

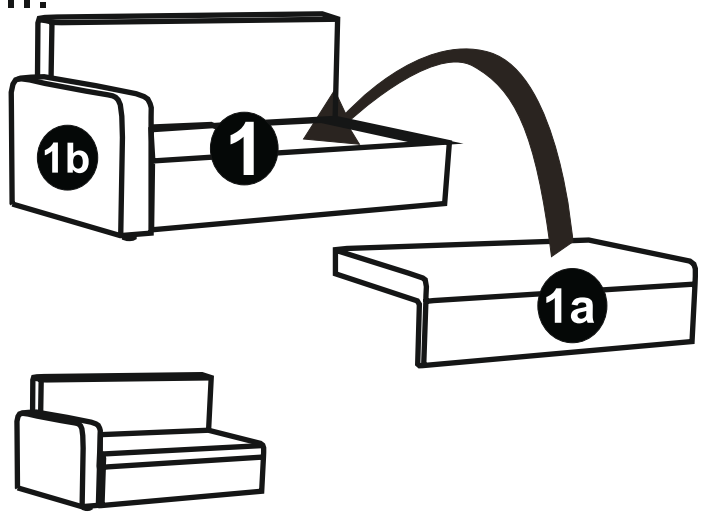

VIII.

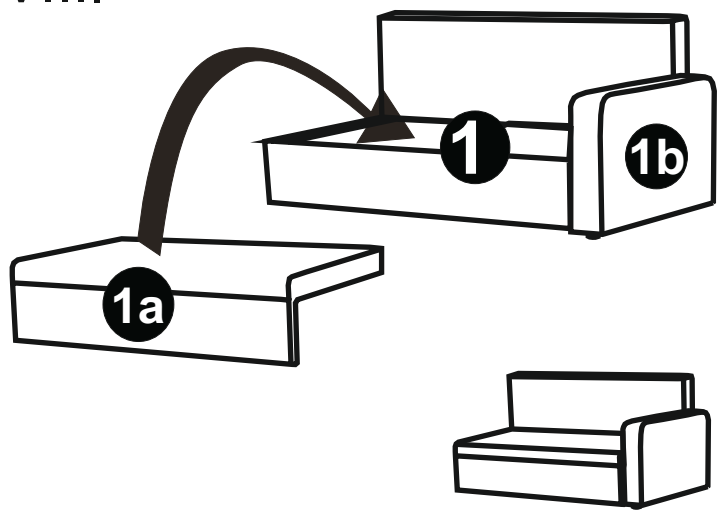

Rhf

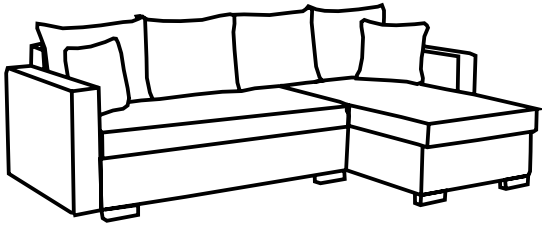

Lhf

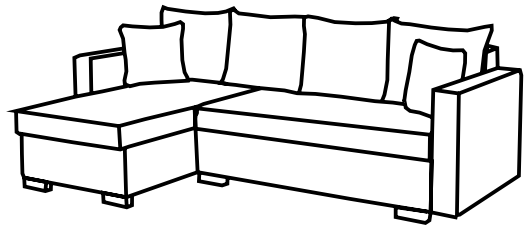

IX.

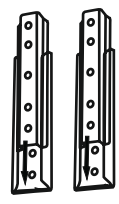
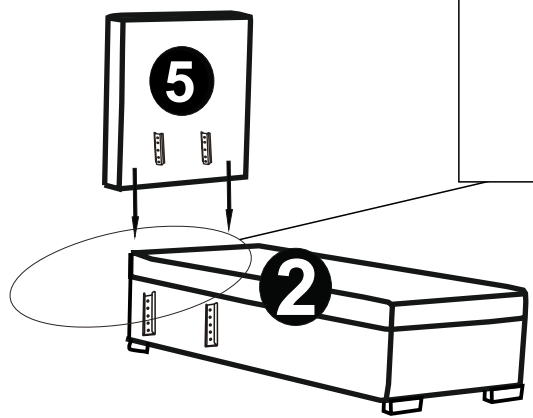

IX.

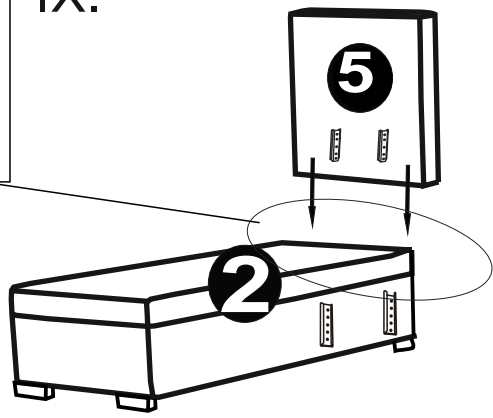

X.

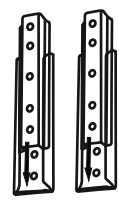
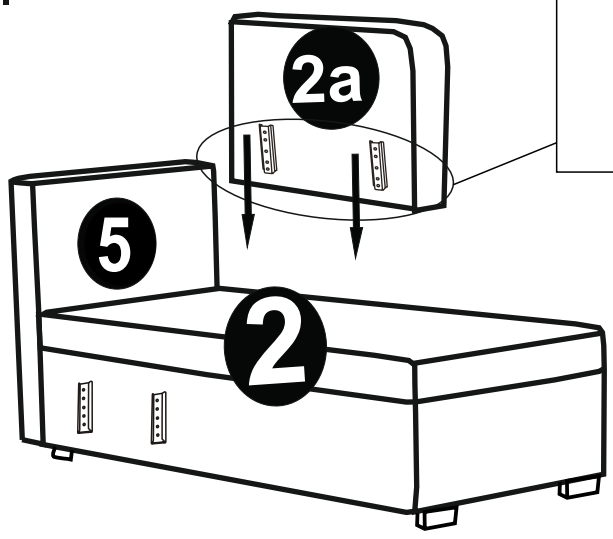

X.

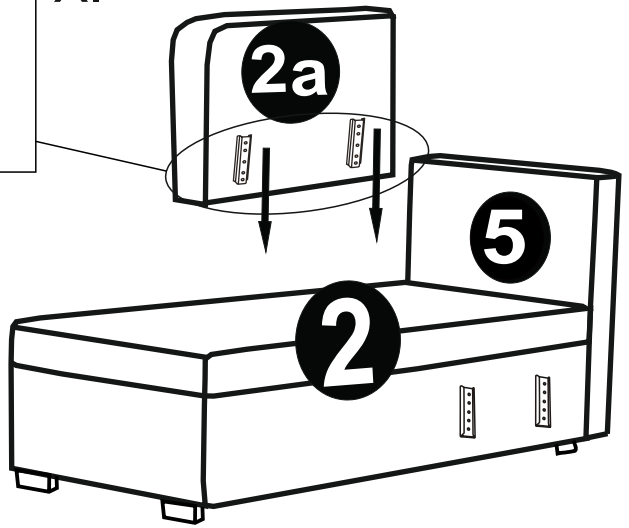

XI.

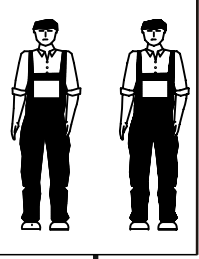
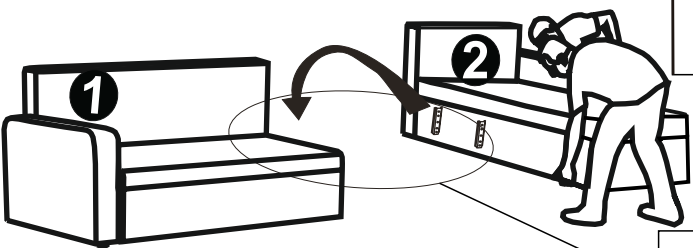

XI.

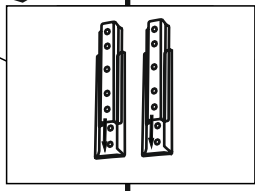
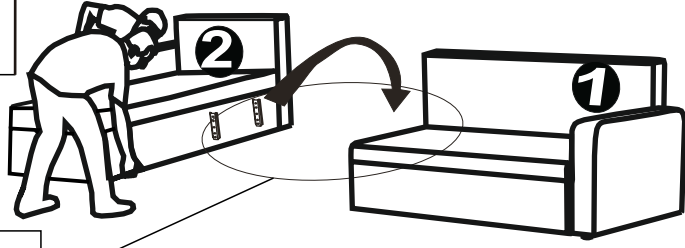

Rhf

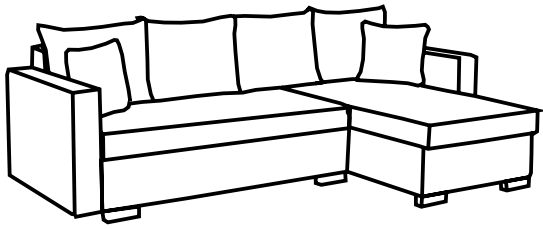

Lhf

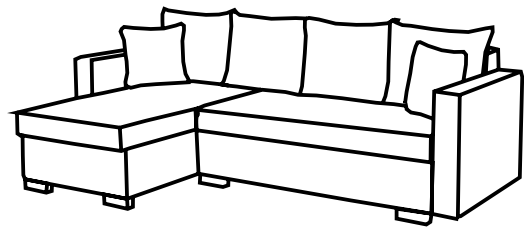

XII.

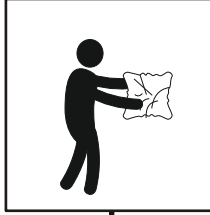

XII.

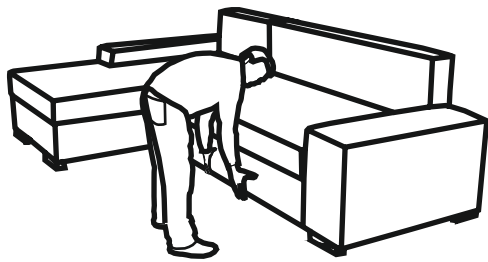
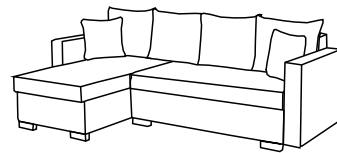
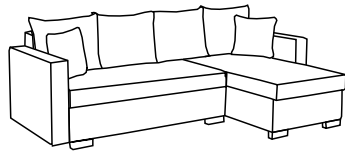
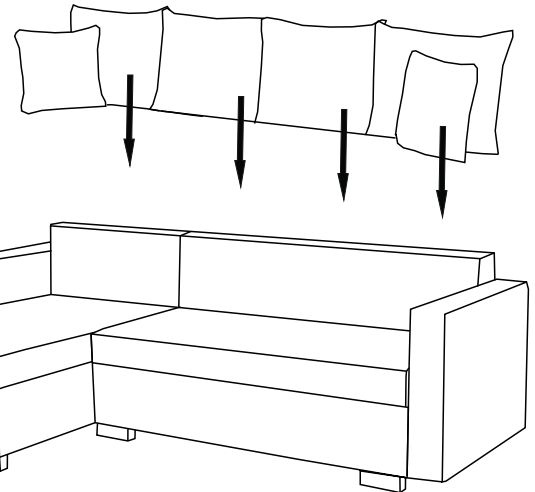
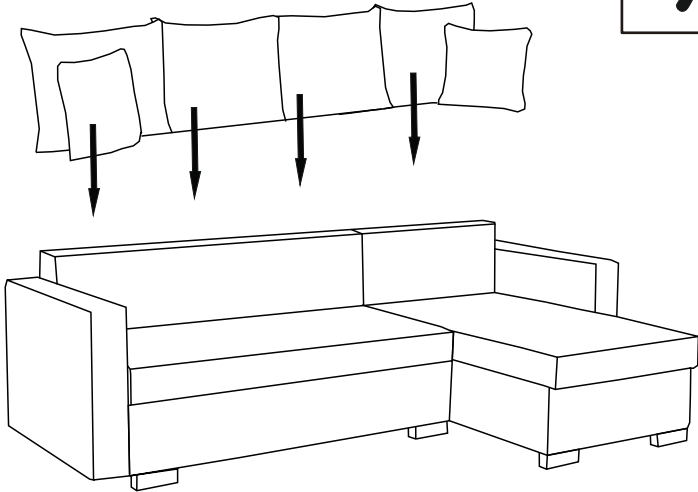

I A



I B

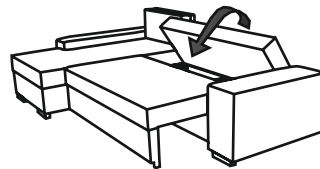

I C

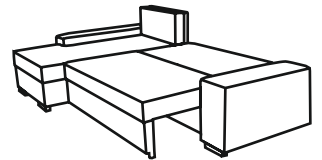

I D