

ROBERTO 2

Art.-Nr.

15 550 205-01
15 550 205-02

1100
1846
320
[mm]

1 / 8
VO
7-2026

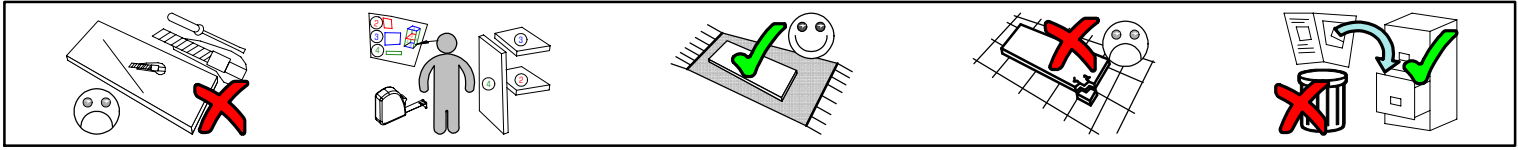
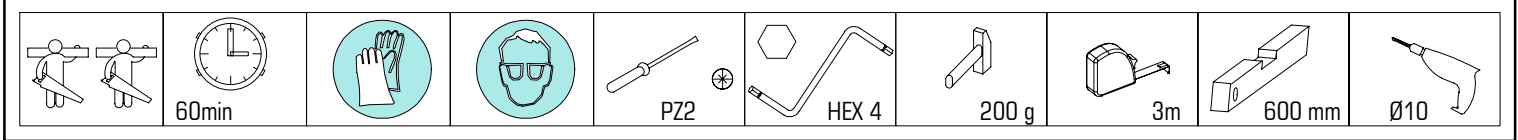

ID	ID	Image	Quantity	Unit
23152	②	1814*318*16	1x	1/2
23153	③	1066*316*16	4x	2/2
23154	④	350*314*16	4x	1/2
23155	⑤	350*314*16	1x	1/2
23156	⑥	700*312*16	1x	2/2
23157	⑦	1814*318*16	1x	1/2
23158	⑧	1100*320*16	2x	2/2
23159	⑨	697*160*16	4x	1/2
23160	⑩	270*140*16	4x	1/2 2/2
23161	⑪	286*673*3	2x	1/2

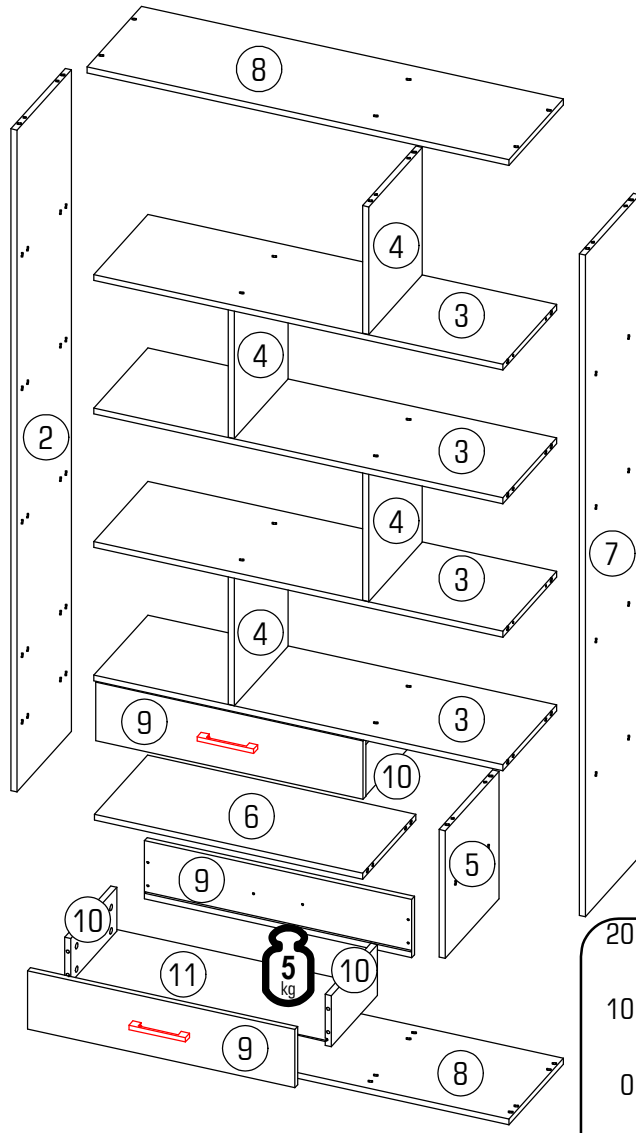
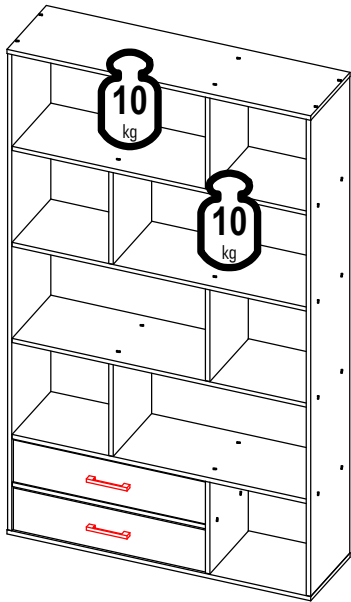

		22255.00		22244.01		24101.00		22300.00		22800.01		34800.00				
	A	16x	B	1x	C	2x	D	24x	E	1x	F	48x	G	1x	H	6x
		27000.00		70013.01		70021.01		31103.00		50553.00		32041.00		22280.00		22280.00
	J	48x	K	18x	L	16x	M	16x	N	1x	P	8x	Q	4x	R	8x

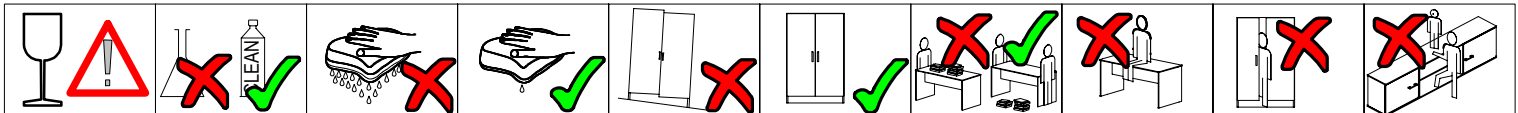

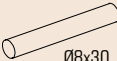
	Ø8x30
J	48x

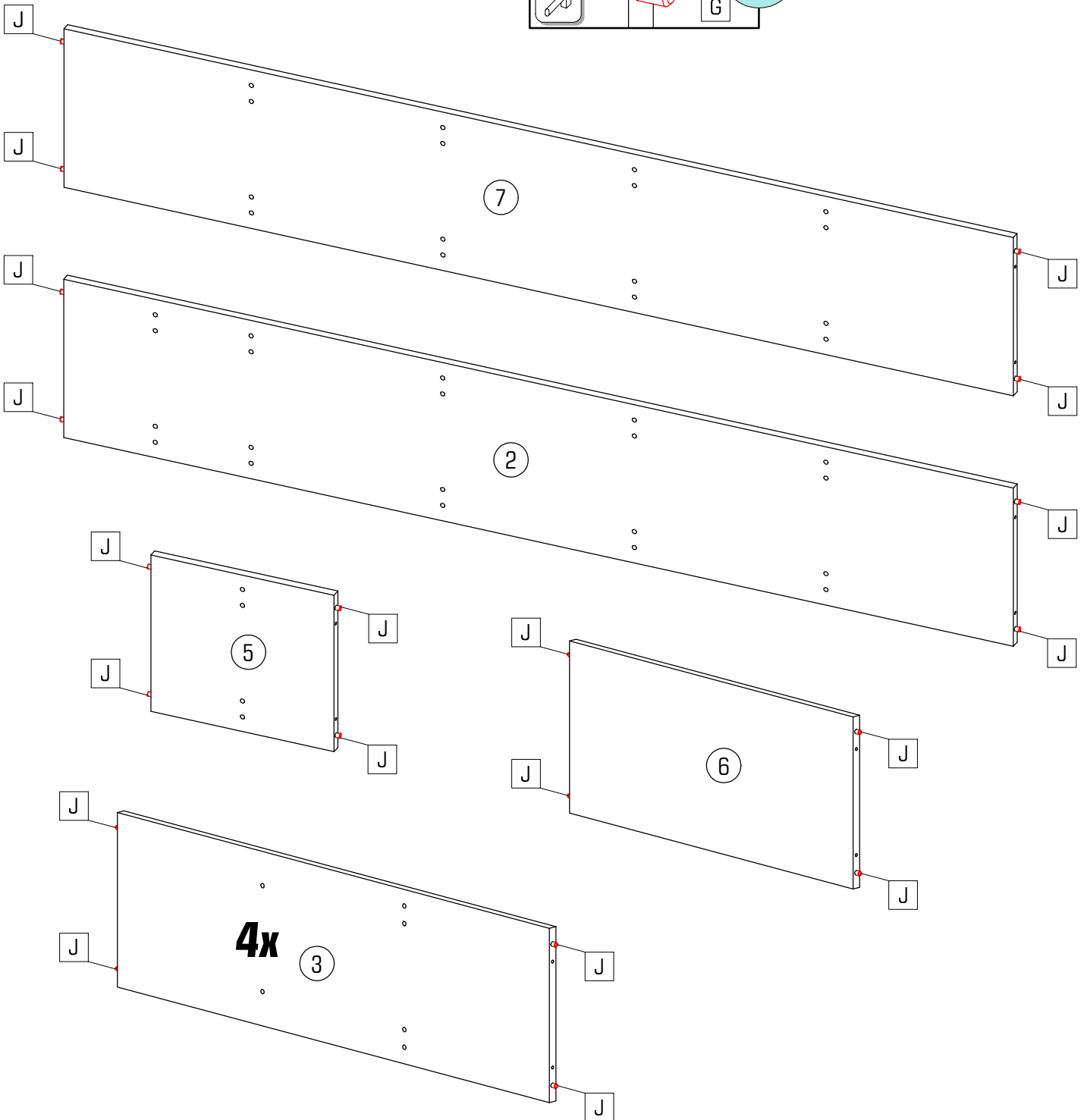
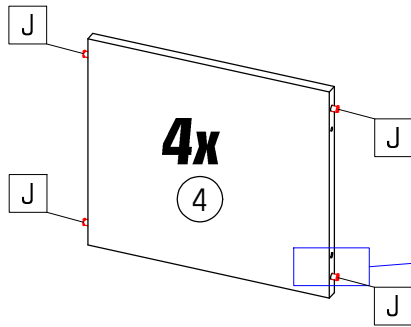
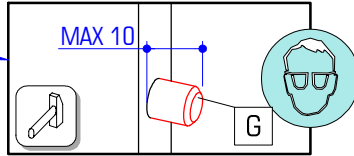
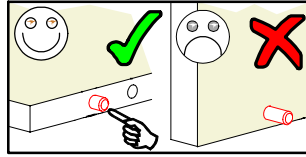
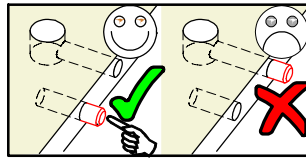

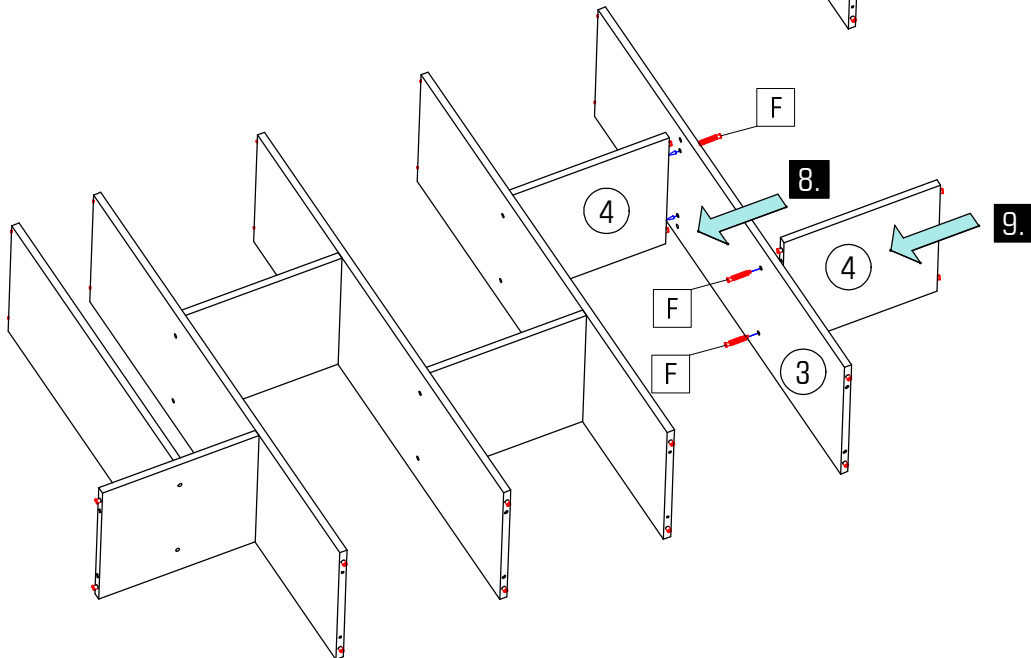
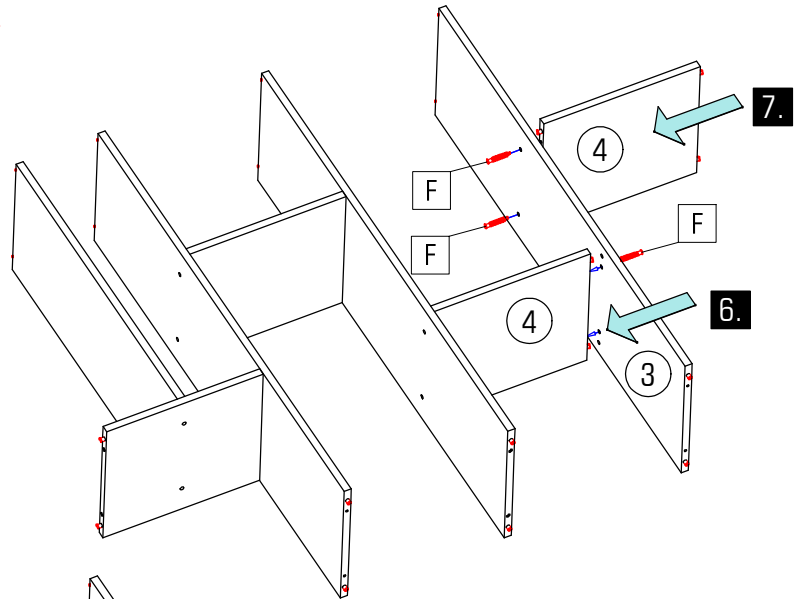
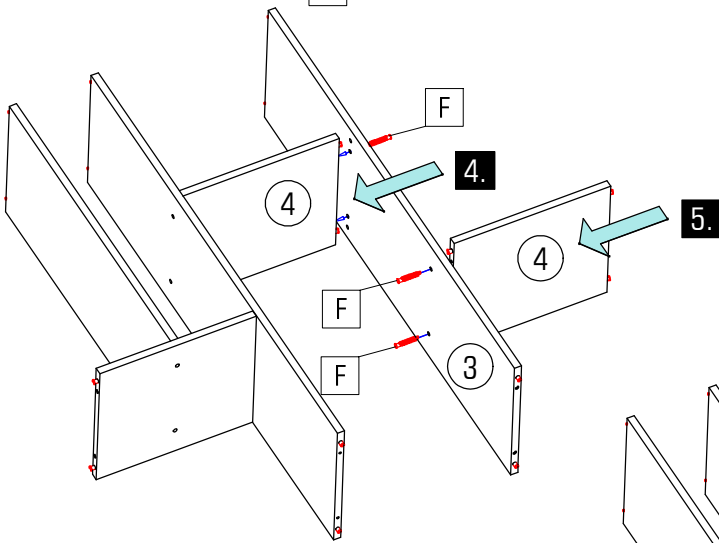
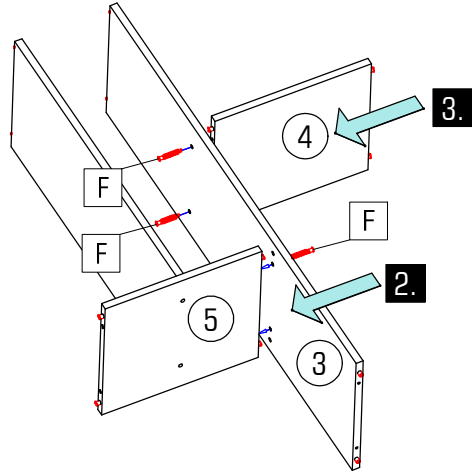
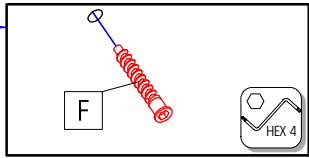
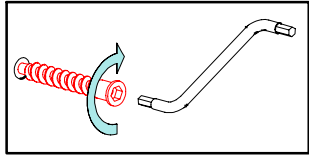
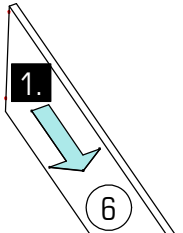
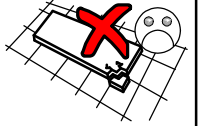
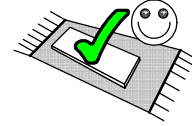
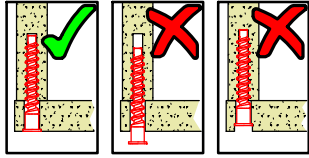
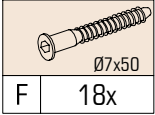





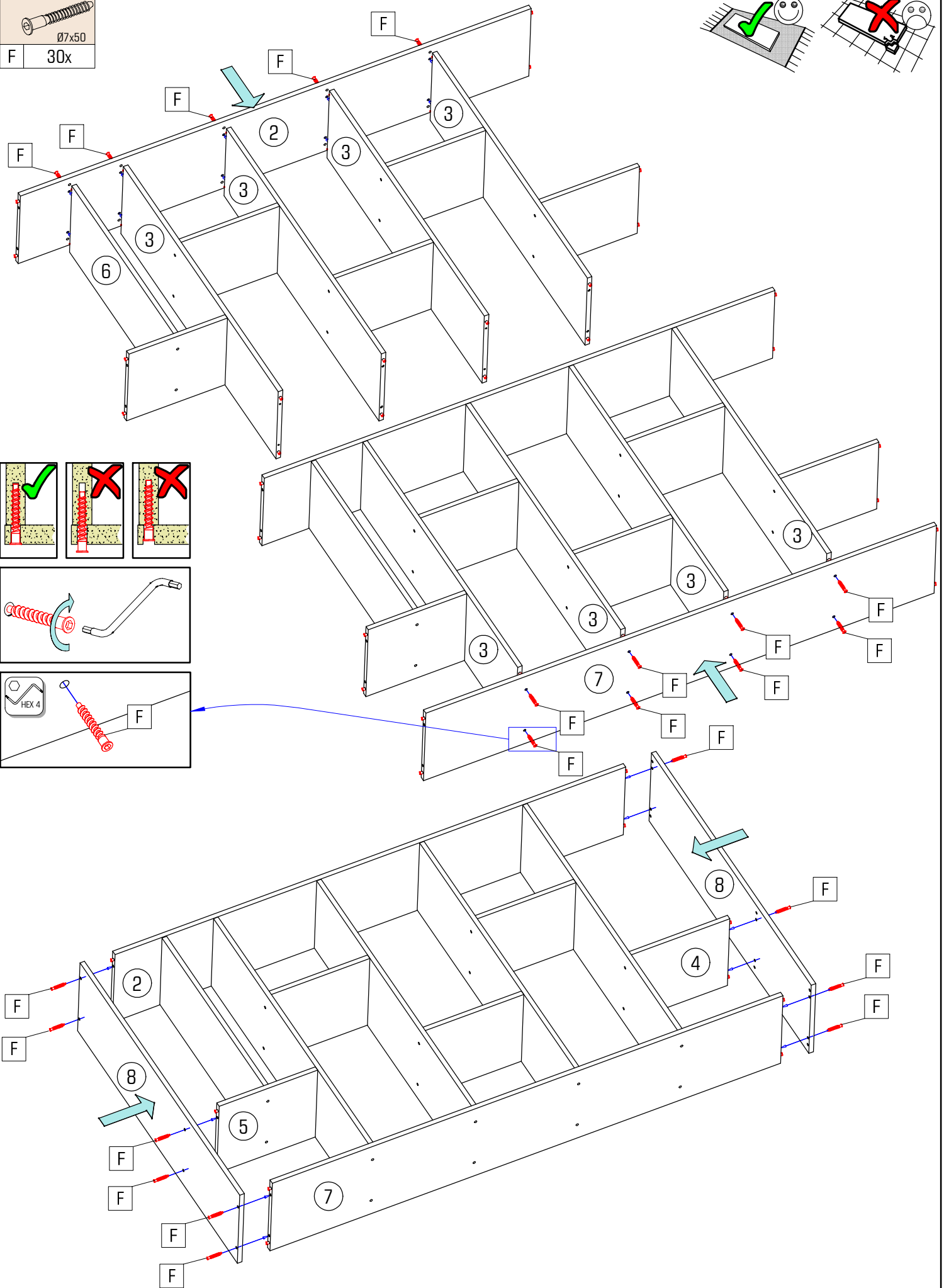
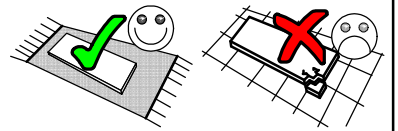



F 30x

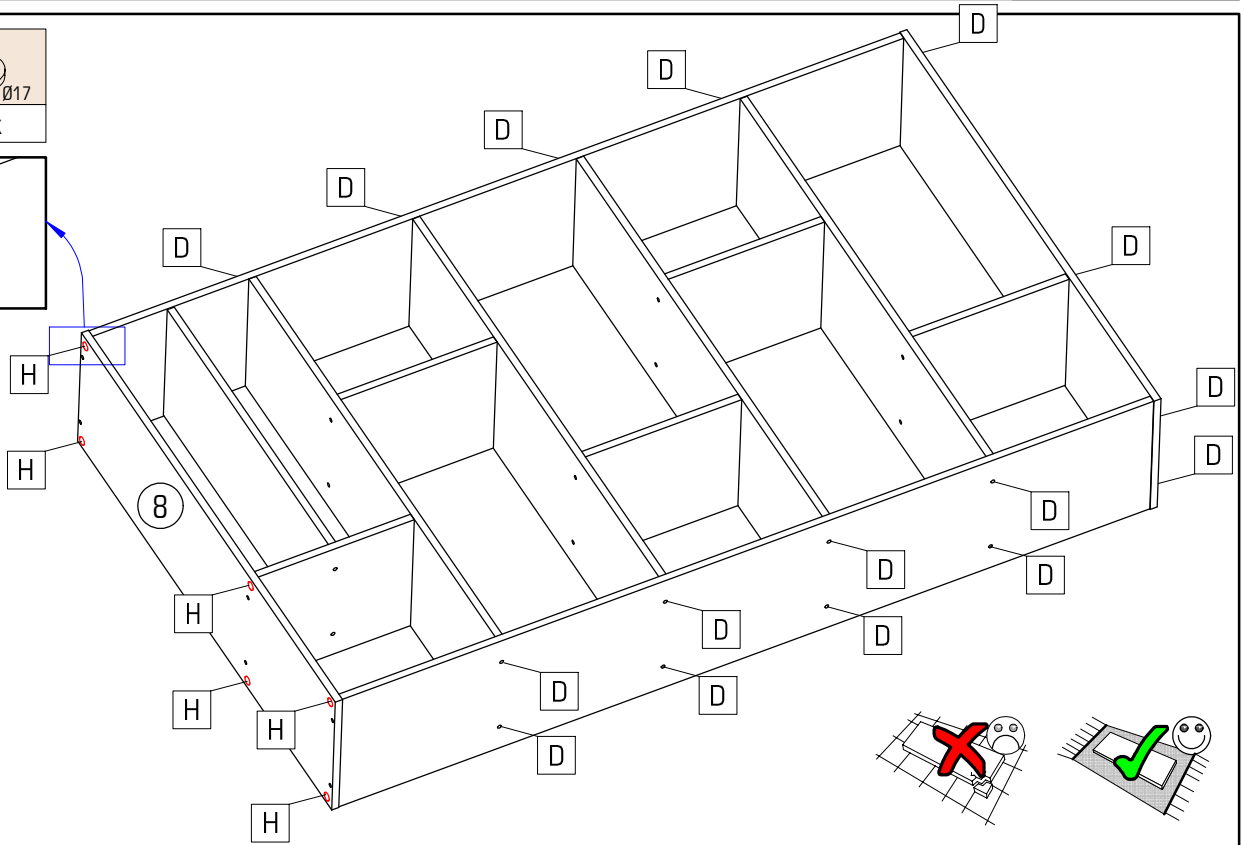
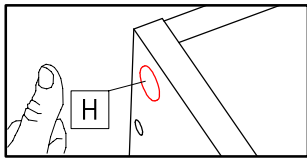

	
D 24x	H 6x

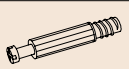

			
L 16x	M 16x	Q 4x	R 8x

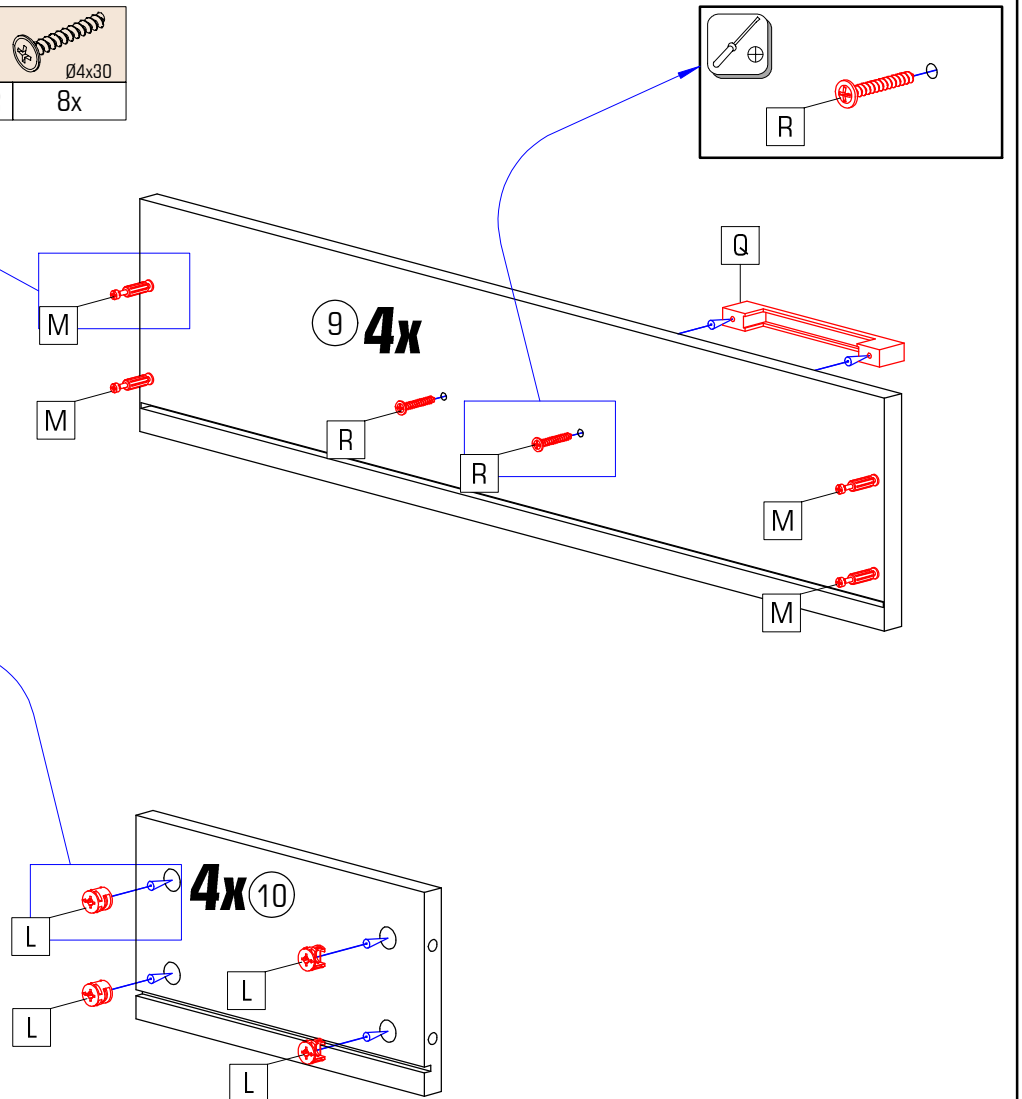
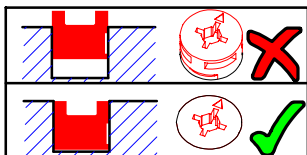
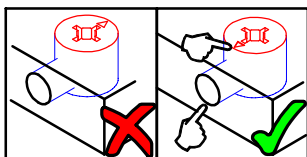
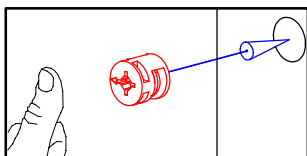
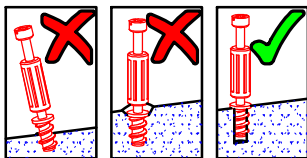
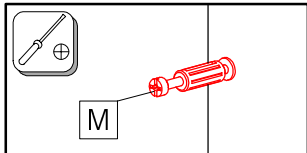



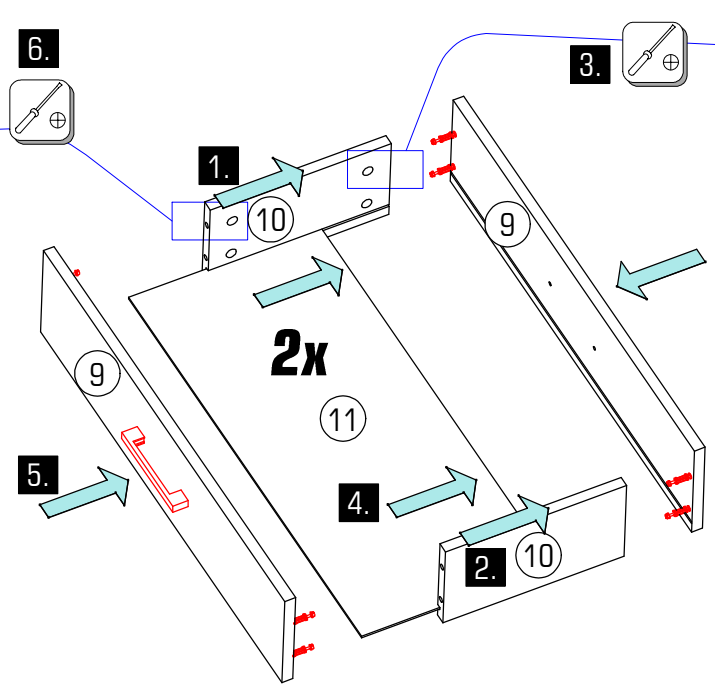

A 16x	P 8x	

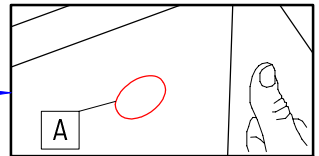
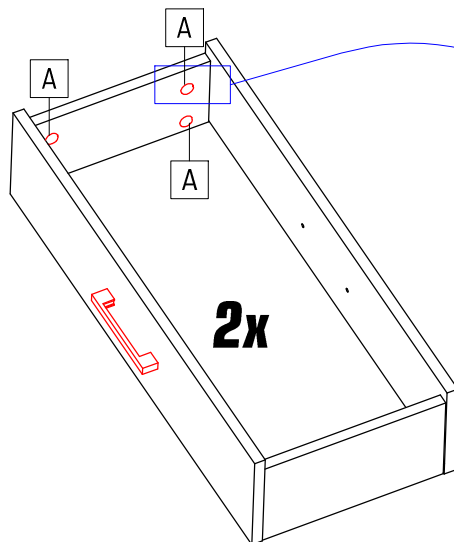
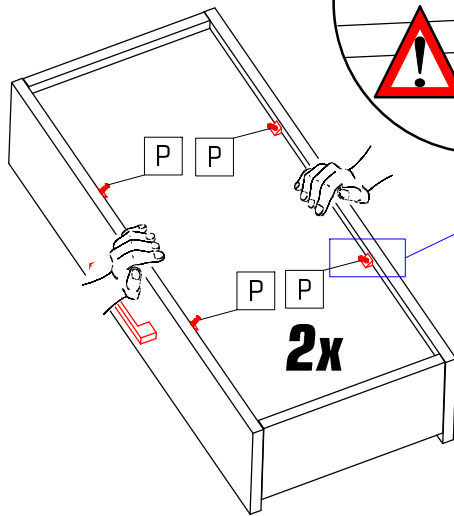
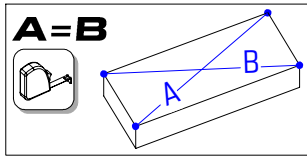
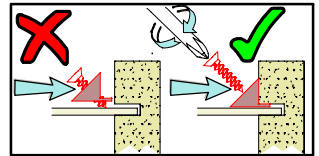
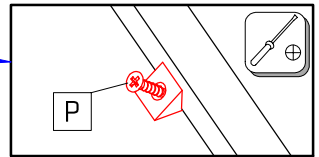
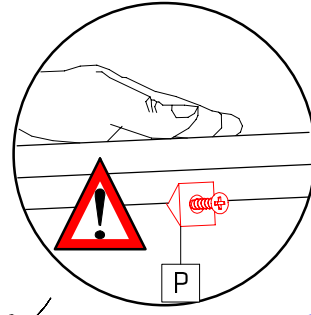
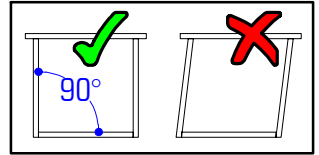
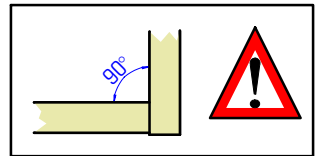

START	MIN	MAX



			
B	C	E	N
1x	2x	1x	1x

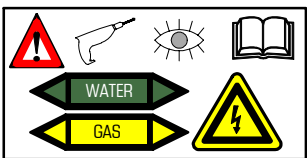
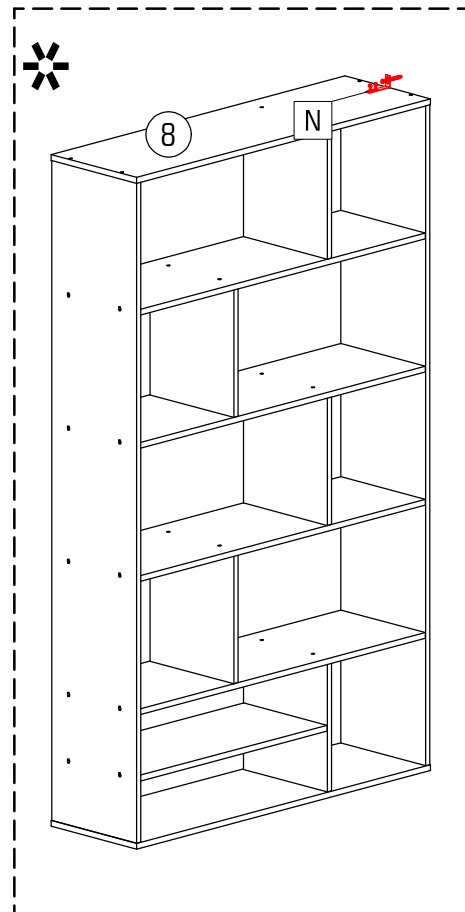
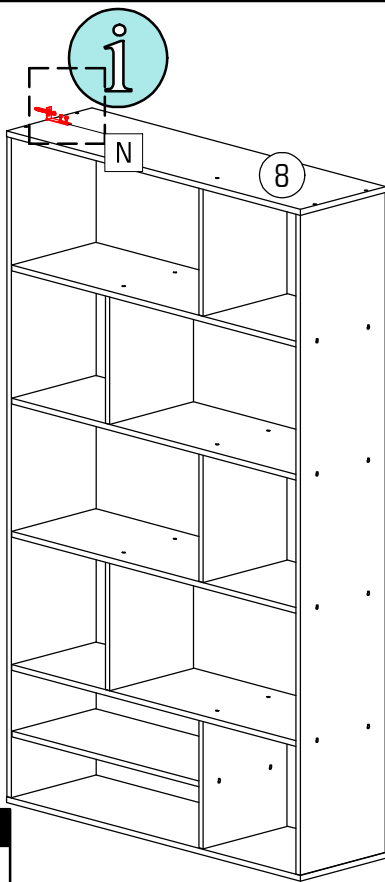
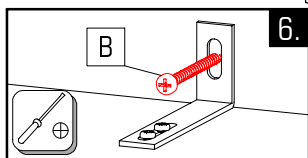
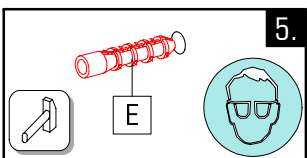
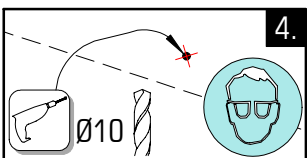
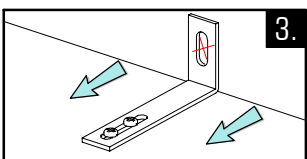
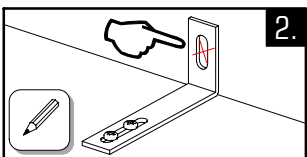
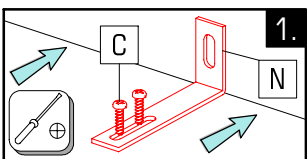

SK	VÝSTRAHA
CZ	VAROVÁNÍ
HR	UPOZORENIE
DE	WARNUNG
HU	FIGYELEM
PL	OSTRZEŻENIE
RO	AVERTIZARE
EN	WARNING
SI	OPOZORILO

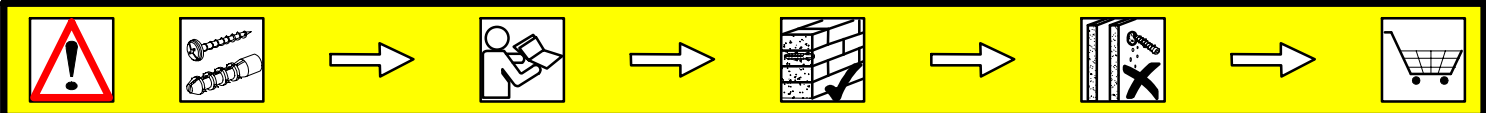
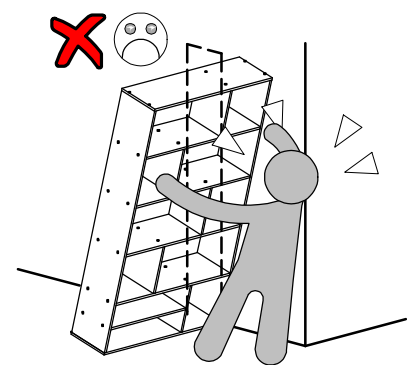
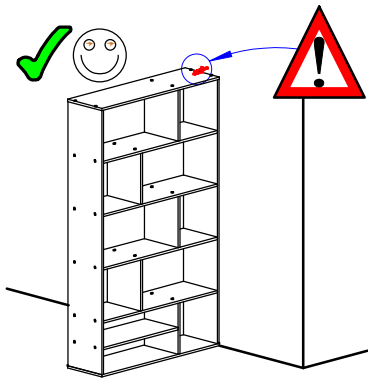
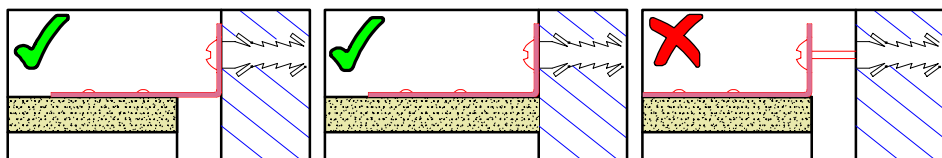

SK Upozornenie! Pevnosť steny sa musí pred montážou bezpodmienečne skontrolovať. Priložené univerzálne hmoždenky používajte jedine pre pevné murivo ako je betón/tehla. Hmoždenky sa nesmú používať v prípade ľahkého stavebného muriva, dutá tehla, sádkartónová doska, alebo iných konštrukcií rámu. U týchto stien je nutné použiť špeciálne hmoždenky! Tieto je možné dostať v špeciálnych predajniach so stavebným materiálom. Pri nedodržení pokynov nepreberajú výrobca/predajca a dodávateľka zodpovednosť za vzniknutú škodu.

CZ Upozornění! Před montáží je nutné zkontrolovat stav stěny. Příložené univerzální hmoždinky jsou určeny pouze k použití pro pevné zdivo jako beton/cihly. Hmoždinky do zdi se nesmí používat u dutinová cihla, zdiva jako pórovitý stavební kámen, sádkartónová deska nebo jiný měkký materiál. U těchto zdív jsou nutné použít speciální hmoždinky! Jsou k dostání v speciálních prodejnách se stavebním materiálem. Při nedodržení těchto pokynů výrobce/prodejce a dopravce neručí za způsobené škody.

HR Pažnja! Prije montaže obavezno provjerite svojstvo zida. Priložene univerzalne tiple namijenjene su isključivo za masivne zidove od betona/opeke. Tiple za masivne zidove ne smiju se koristiti za zidove kao npr šupljina opeka laki sastavni elementi, gips-kartonске ploče ili drugi modularni načini gradnje. Za te zidove potrebne su eventualno specijalne tiple! Iste su dostupne u specijaliziranim trgovinama građevinskim materijalom. U slučaju nepridržavanja prethodno navedenih napomena, proizvođač/trgovac i uvoznik ne preuzimaju odgovornost!

DE Achtung! Die Wandbeschaffenheit ist vor der Montage unbedingt zu prüfen. Die beigelegten Universaldübel sind ausschließlich nur zur Verwendung für festes Mauerwerk wie Beton/Ziegel. Die Mauerdübel dürfen nicht bei Mauerwerk wie Hohlraumziegel, Leichtbaustein, Gipskartonplatte oder anderer Rahmenbauweise verwendet werden. Bei diesen Mauerwerken sind gegebenenfalls Spezialdübel zu verwenden! Diese sind in einem Fachgeschäft erhältlich. Bei Nichterhaltung wird seitens Produzenten/Händler und Importeur keine Haftung übernommen.

HU Vigyázat! Szerelés előtt a falfelületet feltétlenül vizsgálja meg. A mellékelt univerzális tiplék kizárólag stabil falazathoz használható mint például beton/tégla. A fal tiplé nem használható könnyű építőkövek, üreg tégla, gipszkarton lapokhoz vagy más fagyázás építményekhez. Ezekhez a falfelületekhez csak speciális tiplék használhatóak, melyek szaküzletekben (barkácsruházakban) beszerezhetőek. Fentiek figyelmen kívül hagyása esetén a gyártó/kereskedő vagy forgalmazó nem vállal felelősséget.

EN Caution! The wall must be examined before assembly. The included universal wall plugs are only suitable for using in firm masonry such as concrete block or brick. Do not use the wall plugs masonry such as hollow brick, lightweight block, surfaces such as gypsum plasterboard or other framing systems. If applicable, particular wall plugs must be used! These are available at a specialised store (hardware store). In case of non-compliance, the manufacturer/retailer or importer do not assume liability.

PL Uwaga! Ścianę należy sprawdzić przed montażem. Dołączone uniwersalne kołki rozporowe są odpowiednie tylko do stosowania w mocnych murach, takich jak beton lub cegła. Nie rób za pomocą kołków rozporowych murowanych, takich jak pustak, lekka kostka, powierzchni takie jak płyty gipsowo-kartonowe lub inne systemy ram. Jeśli dotyczy, muszą to być określone kołki rozporowe być użytych! Są one dostępne w specjalistycznym sklepie niezgodnie z producent / sprzedawca lub importer nie ponoszą odpowiedzialności.

RO Prudență! Zidul trebuie examinat înainte de asamblare. Prizele de perete sunt adecvate numai pentru utilizarea în zidurile fermă, cum ar fi betonul bloc sau cărămidă. Nu folosiți zidăria zidurilor de perete, cum ar fi cărămida goală, blocul ușor, suprafețe cum ar fi gips-carton sau altă încadrare sisteme. Dacă este cazul, trebuie folosite anumite prize de perete! Acestea sunt disponibile la un magazin specializat (magazin de hardware). În caz de nerespectare, producătorul / vânzătorul cu amănuntul sau importatorul nu își asumă nerespectarea, producătorul / vânzătorul cu amănuntul sau importatorul nu își asumă.

SI Pozor! Pred montažo preverite stanje stene. Priloženi univerzalni mozniki so izključno samo za uporabo na čvrstem zidovju, kot sta beton in opeka. Stenski mozniki se ne smejo uporabljati pri zidovju kot so votlina opeke, zidaki za lahko gradnjo, mavčne plošče ali druge okvirne gradnje. Pri teh zidovjih morate v danih primerih uporabljati posebne moznike. Ti so na voljo v specializiranih trgovinah (trgovinah z gradbenim materialom). Pri upoštevanju se s strani proizvajalca/trgovca in uvoznika ne prevzame jamstvo.

K 18x

