

wyprodukowano dla / made for / produziert für  
**BEGA GRUPPE**  
producent: **MEBLE OKMED POLAND**

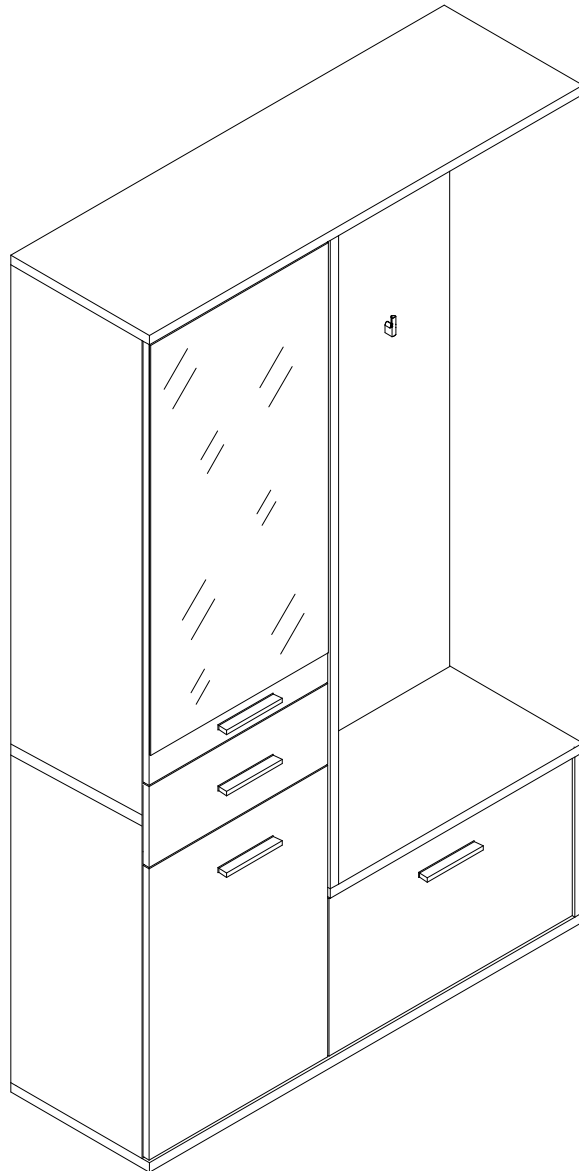

KK1 1	K1 5	K2 14	ZK 6	KSK1 1	KD1 32	KD2 4
ZM1A 22	ZM1B 18	TPP3 2	ZM1 22	PP 12	SS6 6	WV1 7
ZP 5	Z1P 5	ZP 2	Z2P 2	W4 14	S1 15	UST 4
W1 7	W11 8	W12 4	W7 14	W9 3	PQ3 1	PQ4 1
KS1 2	KRW1 2	U99 4	WU 8	WG5 1	SG15 1	

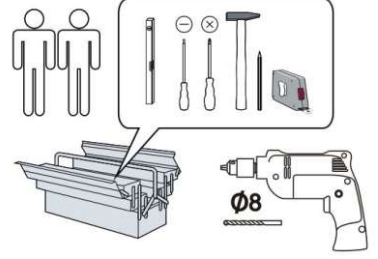
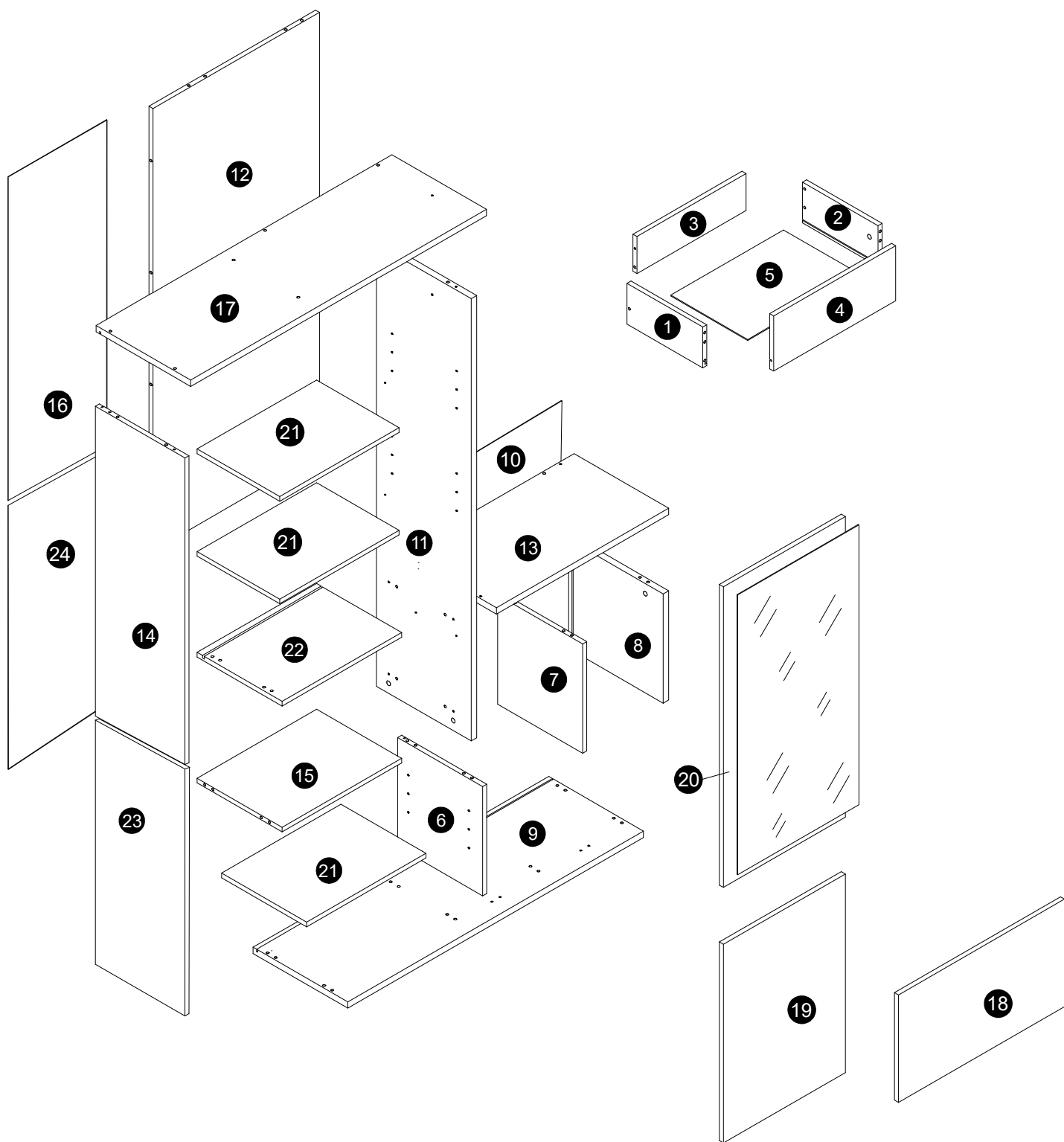
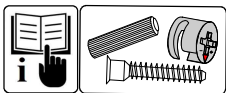
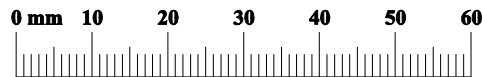

A	1/3			
	B	H	T	
8	375	375	22	x1
9	1172	375	22	x1
11	1518	375	22	x1
13	683	375	22	x1
17	1172	375	22	x1

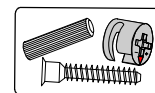

2/3				
	B	H	T	
1	300	140	16	x1
2	300	140	16	x1
3	432	127	16	x1
6	375	355	16	x1
7	375	337	16	x1
21	472	327	16	x3
22	489	355	16	x1
14	1028	355	16	x1
15	472	337	16	x1
23	871	355	16	x1

3/3				
	B	H	T	
4	483	189	16	x1
5	446	305	3	x1
10	660	391	3	x1
12	1518	660	16	x1
16	1044	480	3	x1
19	682	483	16	x1
20	1032	483	16	x1
24	879	480	3	x1
18	658	369	16	x1

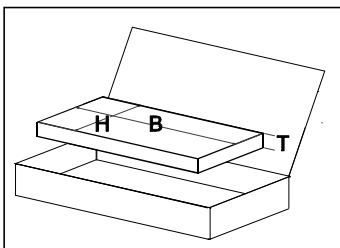

## 01

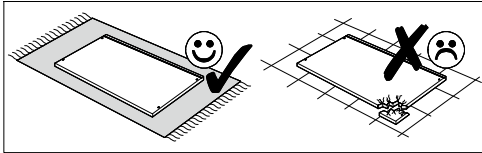

	8x35		8x60		ZM1A		GLUE
KD1	4	<del>KD2</del>	1	ZM1A	2	KSK1	1

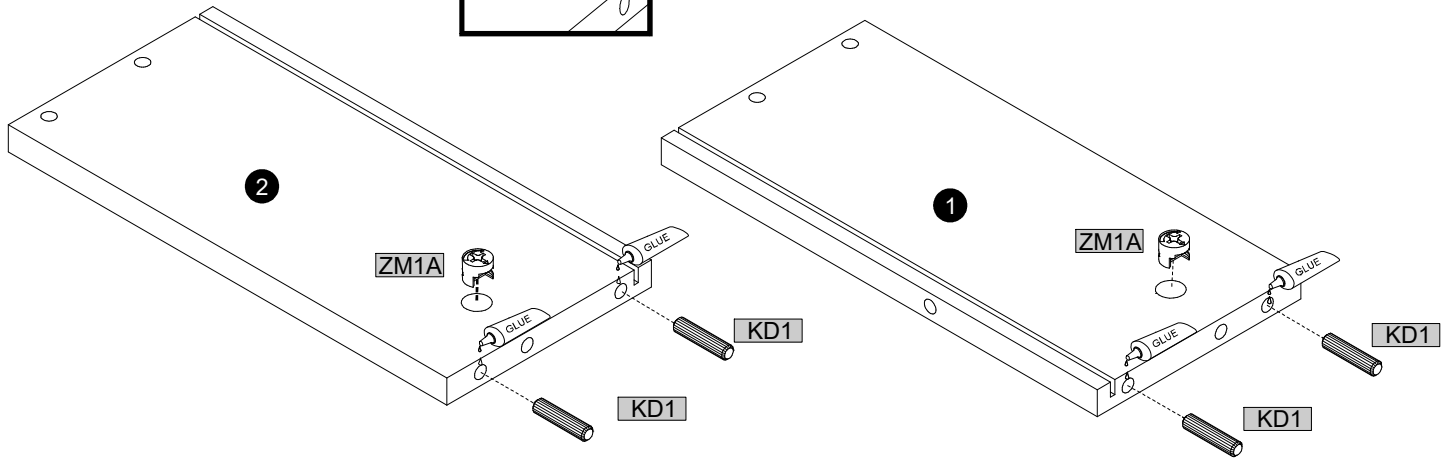
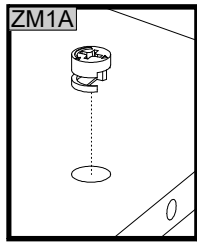

## 02

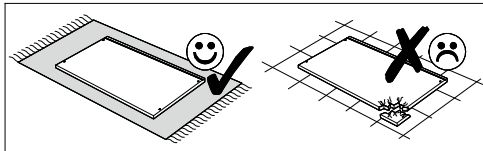

	8x35		8x60		GLUE
KD1	2	<del>KD2</del>	1	KSK1	1

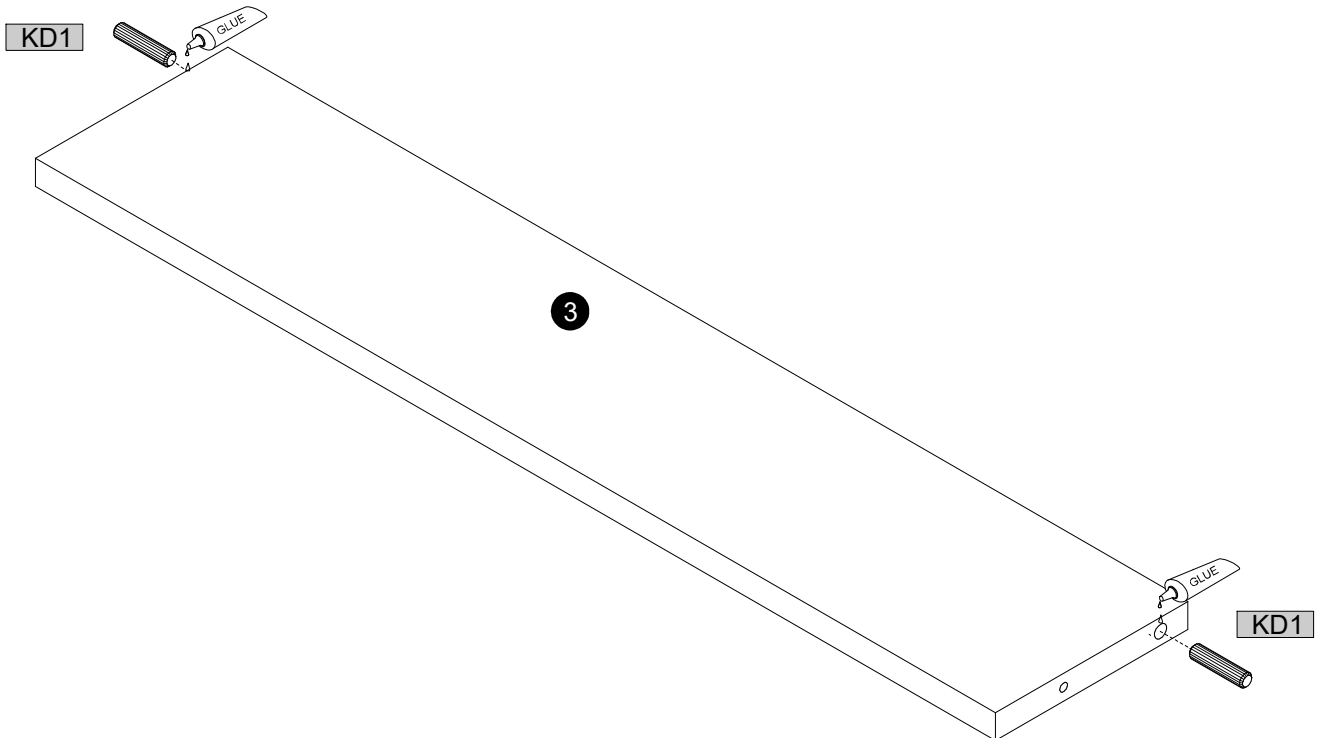

### 03

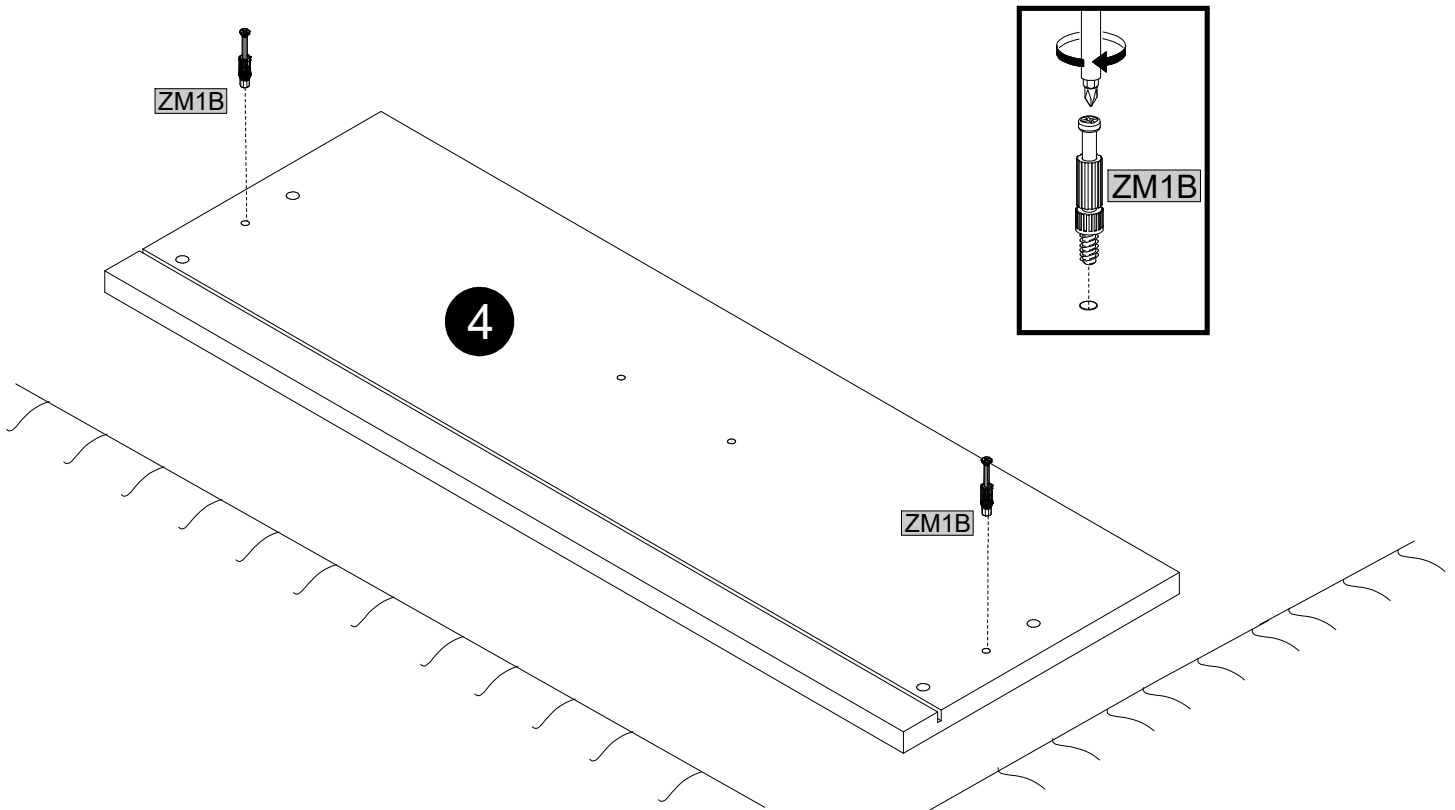
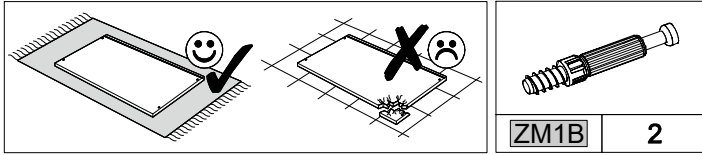

### 04

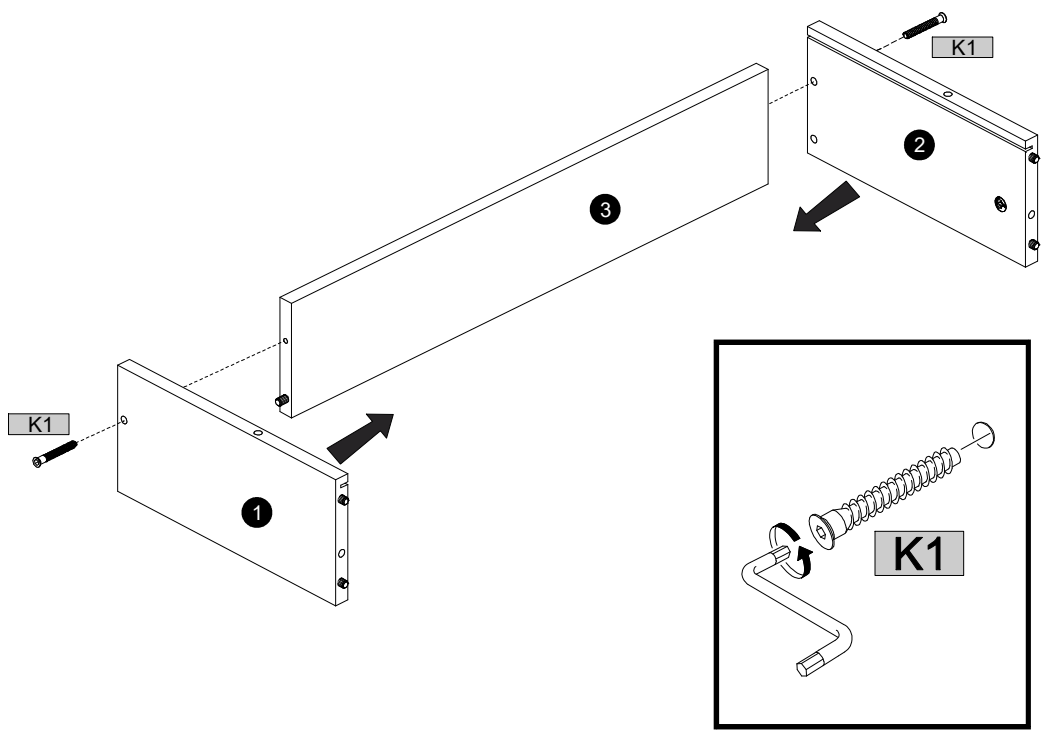
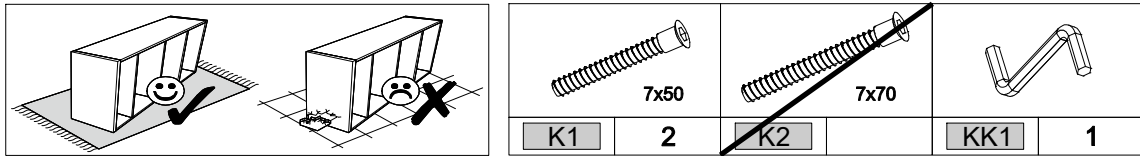

### 05

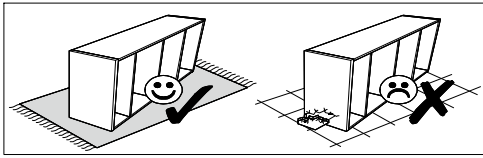

	2		1		1
ZM1		KK1		KSK1	

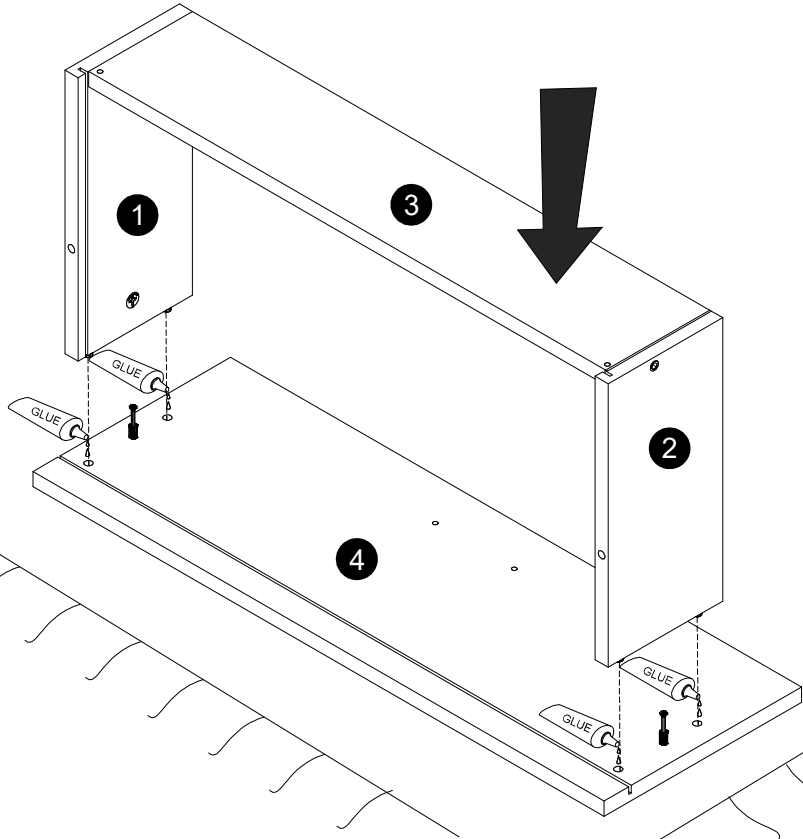
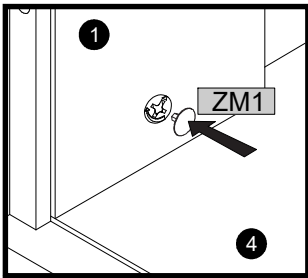
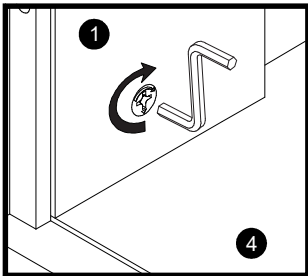
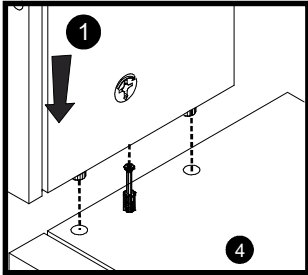

### 06

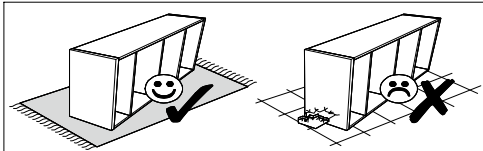

	4		1
W1		S1	

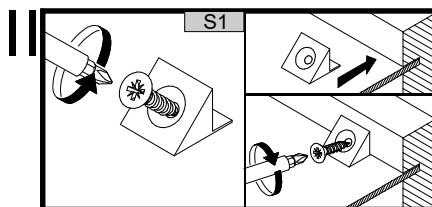
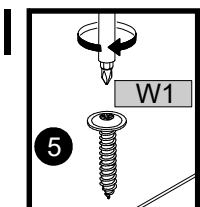
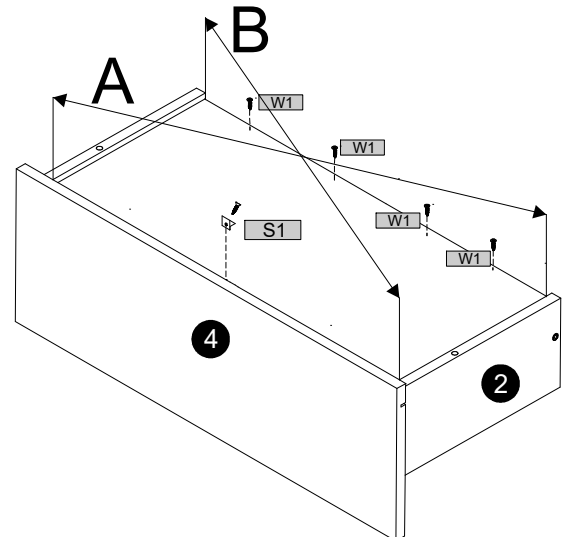
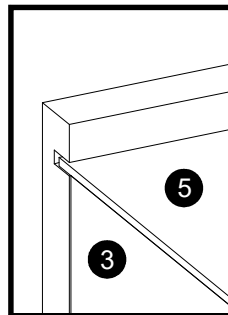
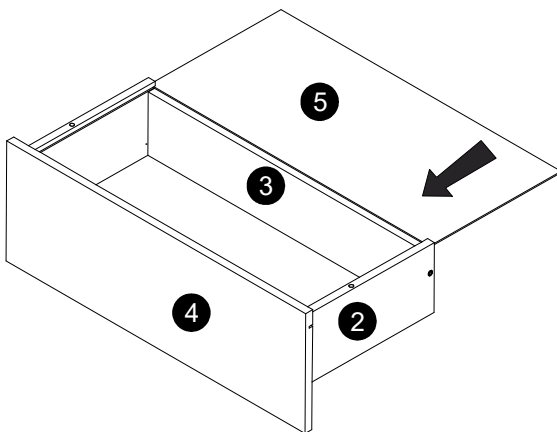

### 07

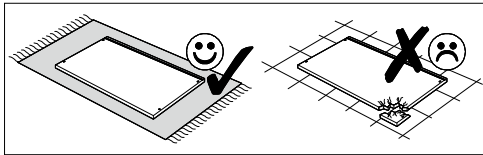

	8x35				8x60		
KD1	2	ZM1A	2	KD2	2	PP	2

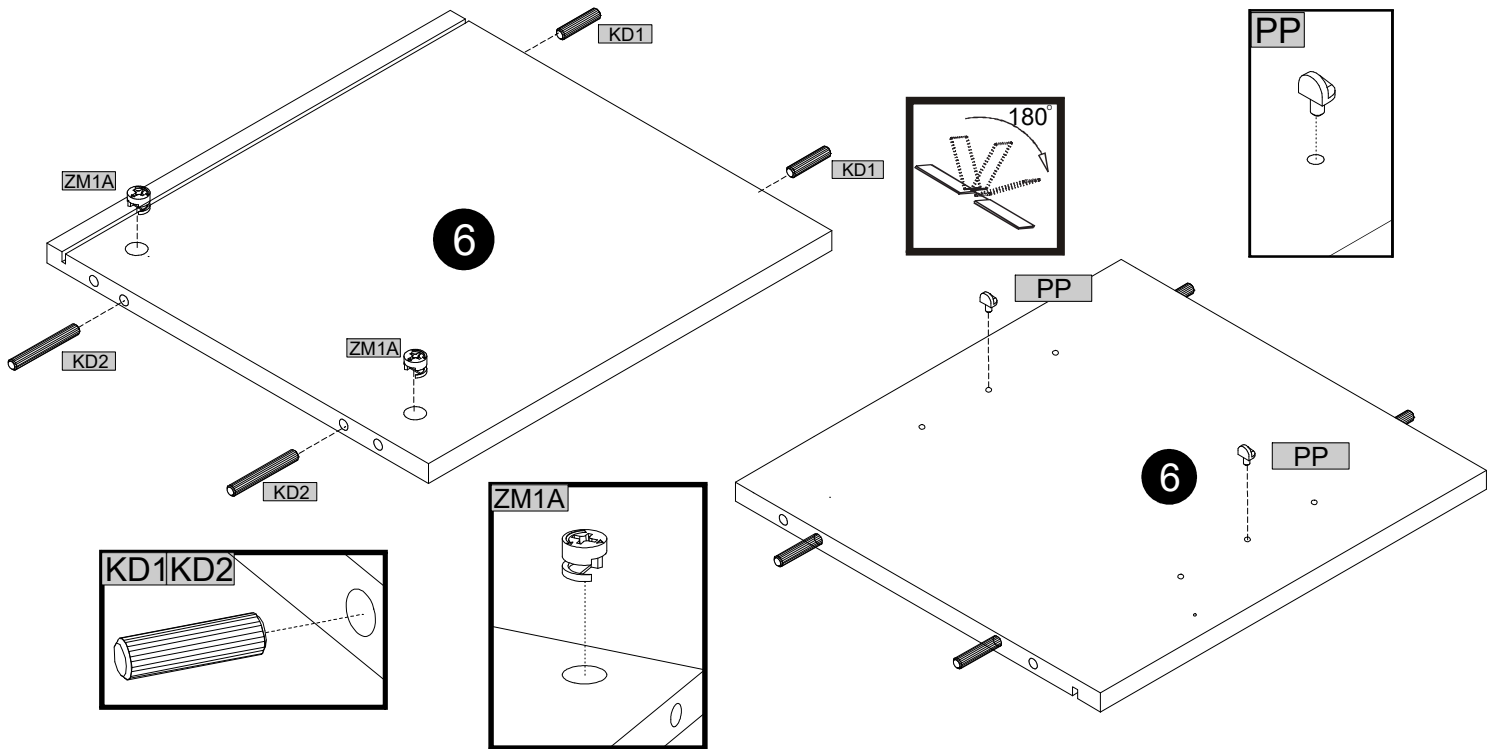

### 08

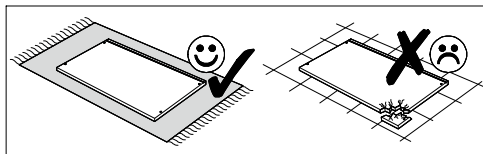

	8x35		8x60				60N
KD1	4	<del>KD2</del>	<del>1</del>	ZM1A	2	SG15	1

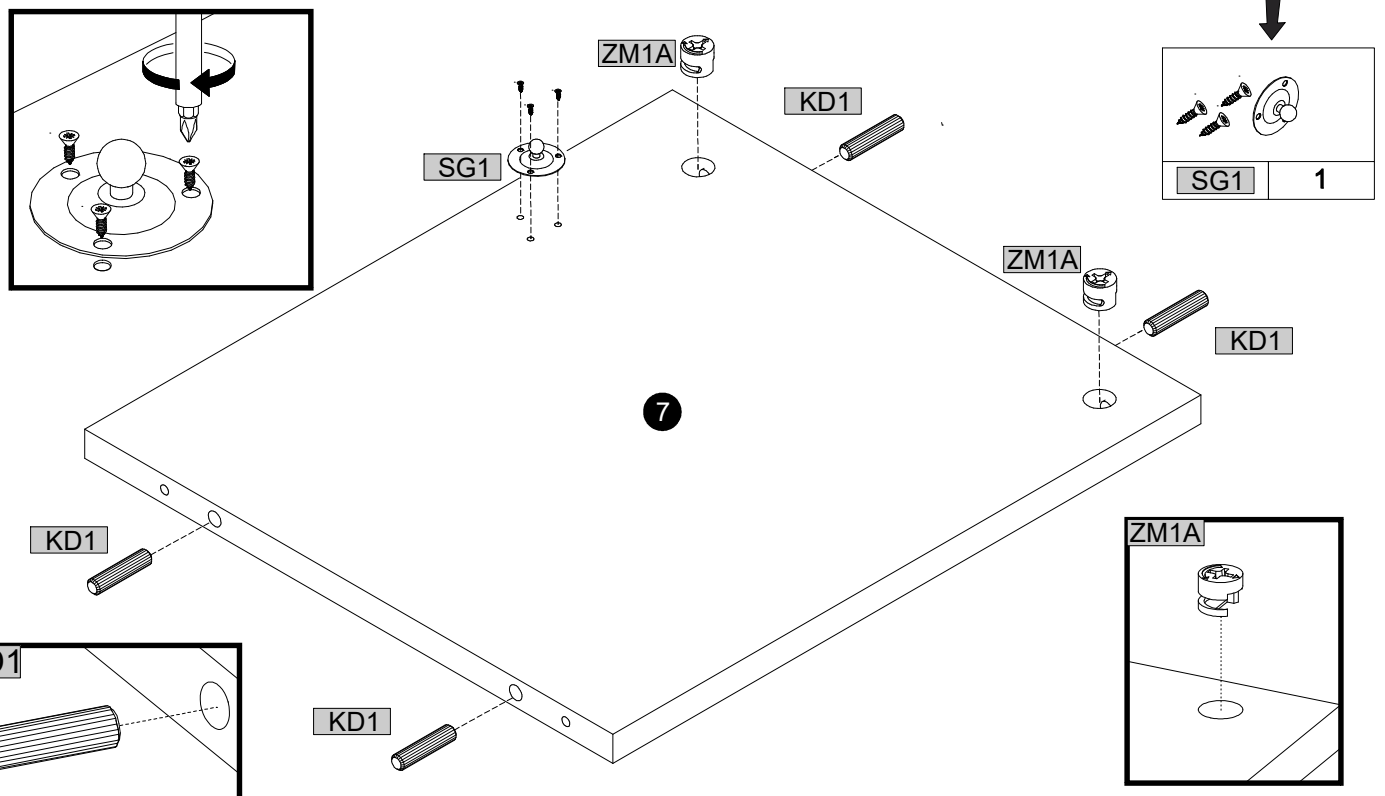

09

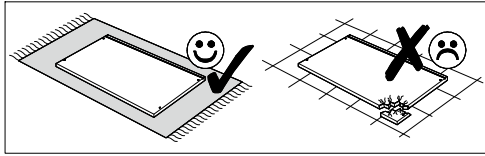

	8x35		8x60		
KD1	4	<del>KD2</del>	<del>1</del>	ZM1A	2

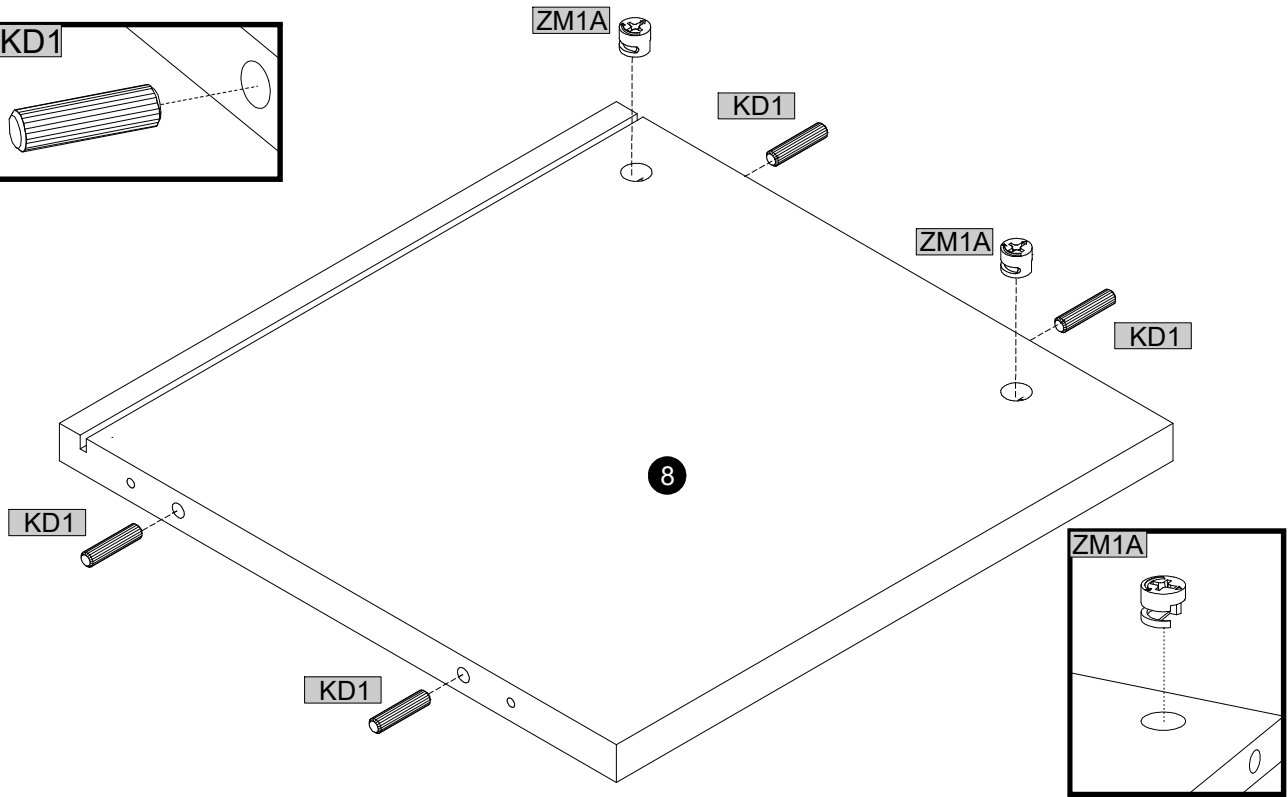
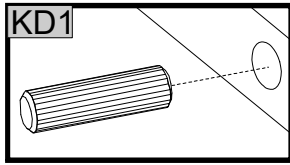

10

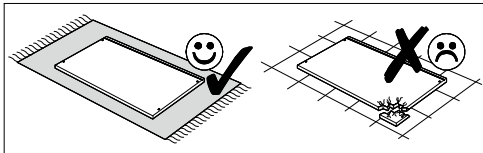

	ZM1B	10
--	------	----

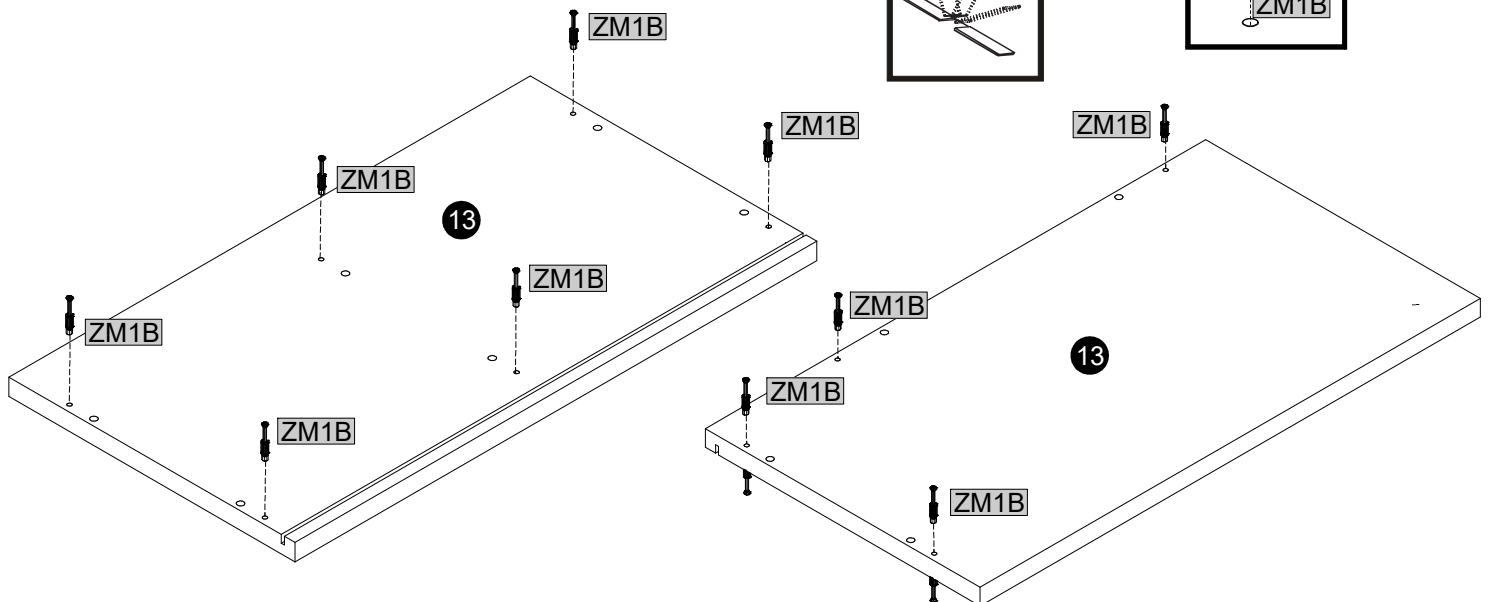
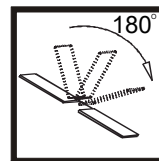
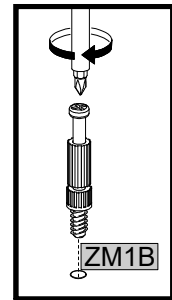



### 11

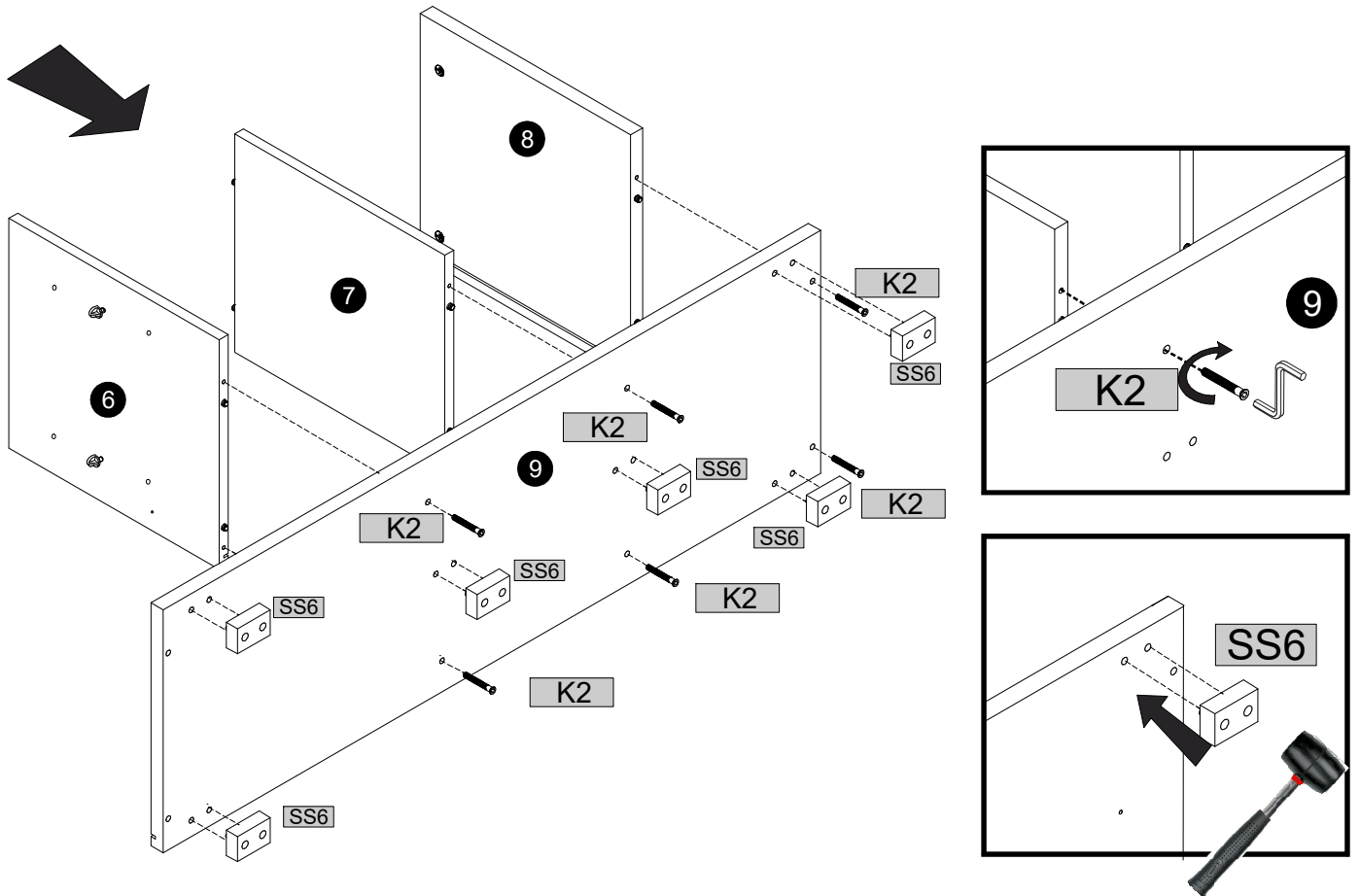
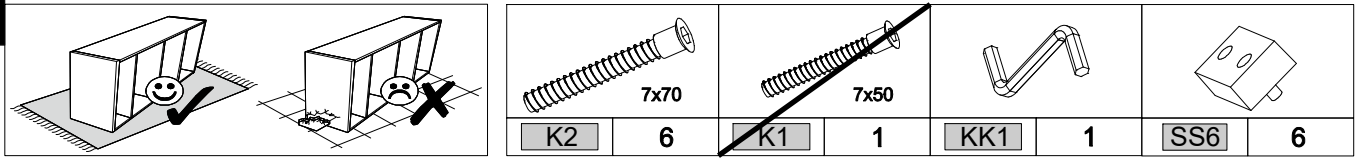



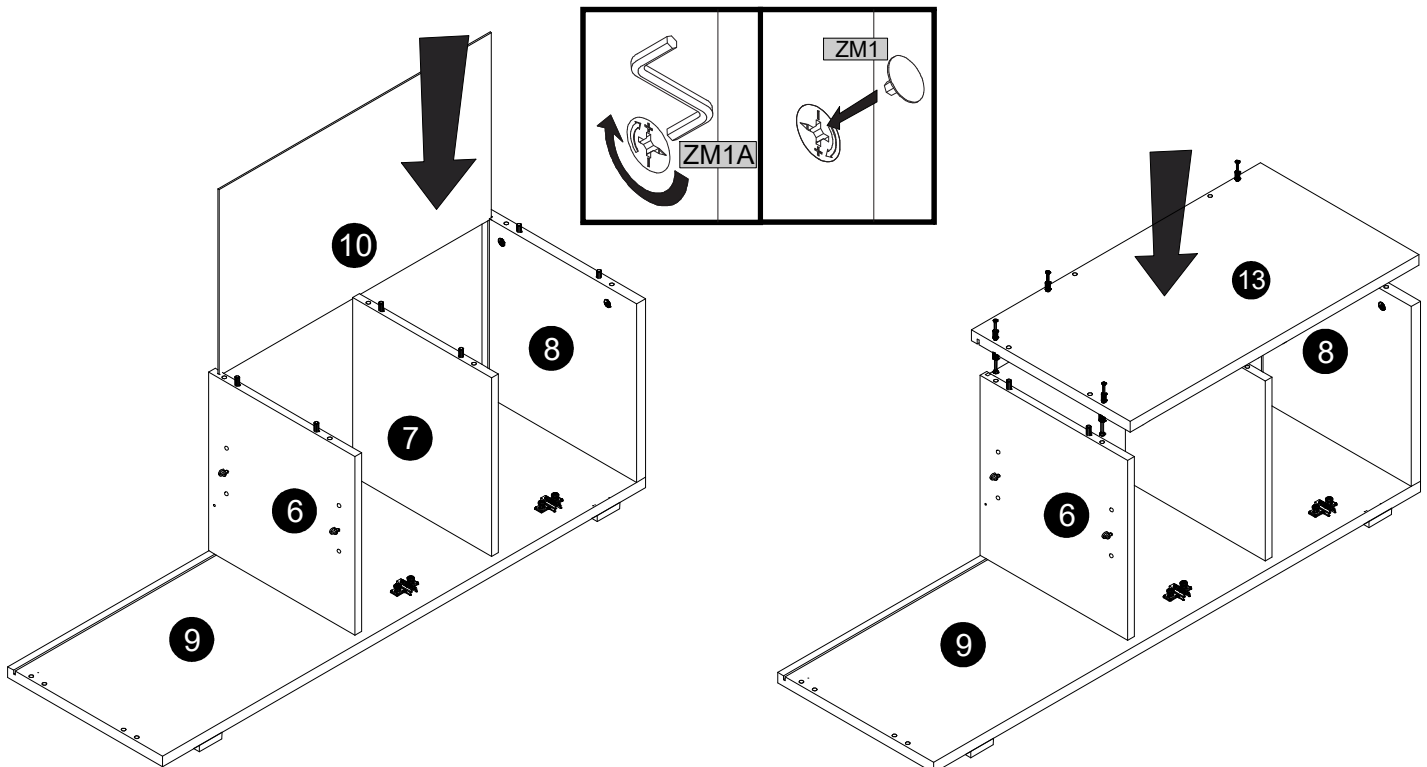
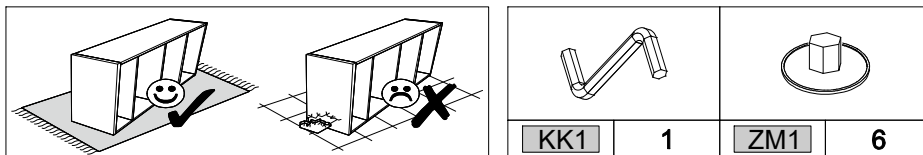

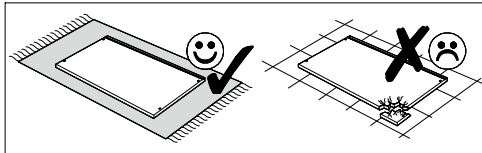

### 12

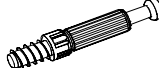
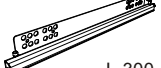

## 13



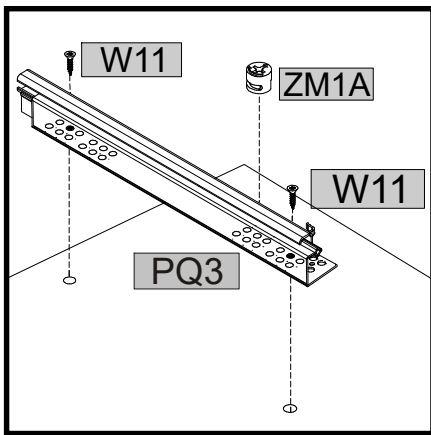
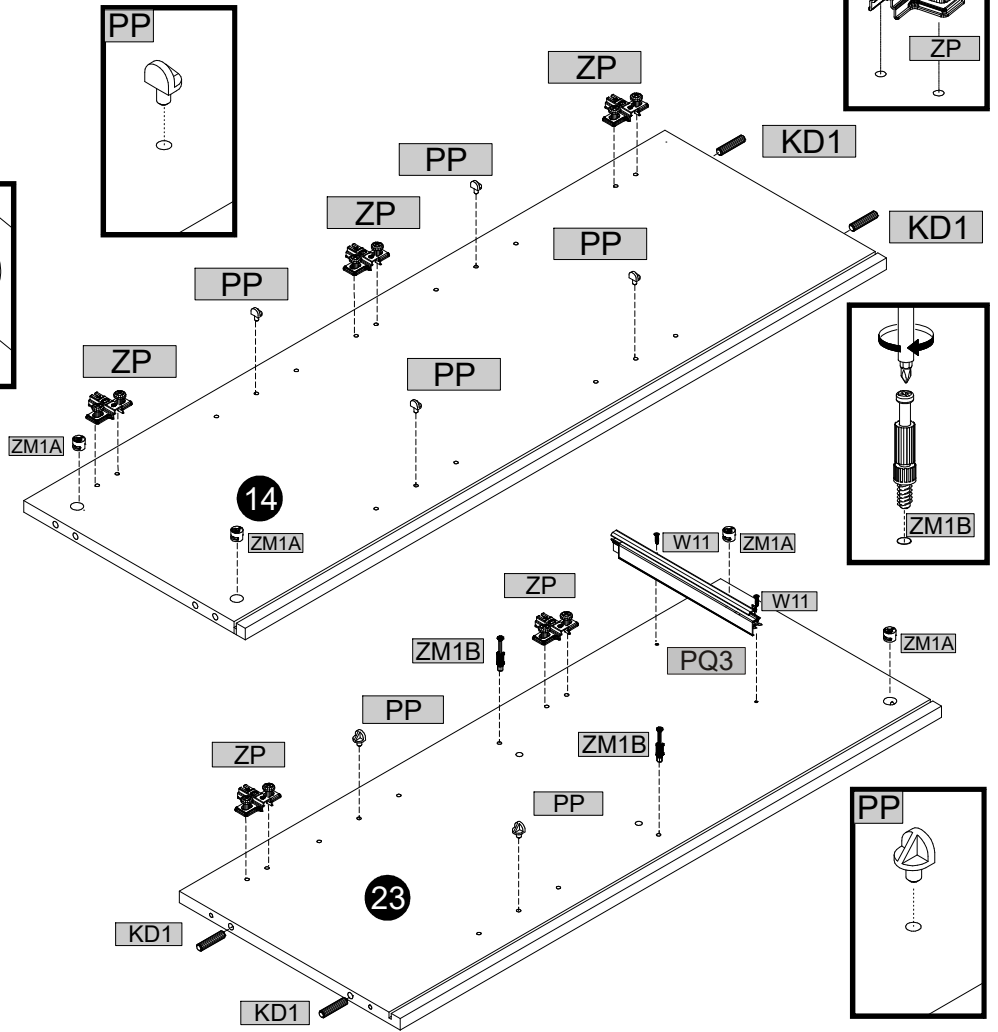
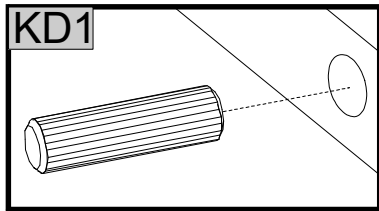
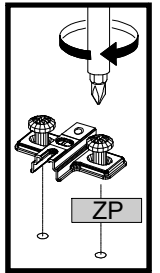
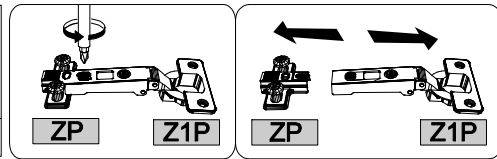

	8x35						L-300
KD1	4	PP	6	ZM1B	2	PQ3	1

	3,5x16				
W11	2	ZM1A	4	ZP	5

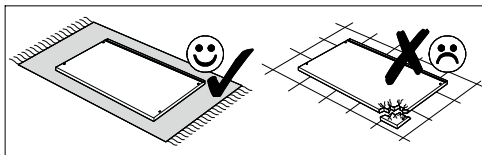

## 14

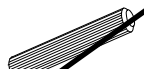

			8x35		8x60
ZM1A	4	KD1	4	<del>KD2</del>	1

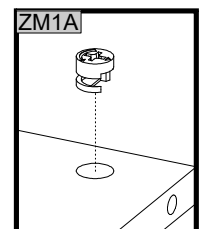
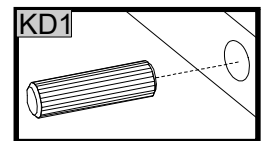
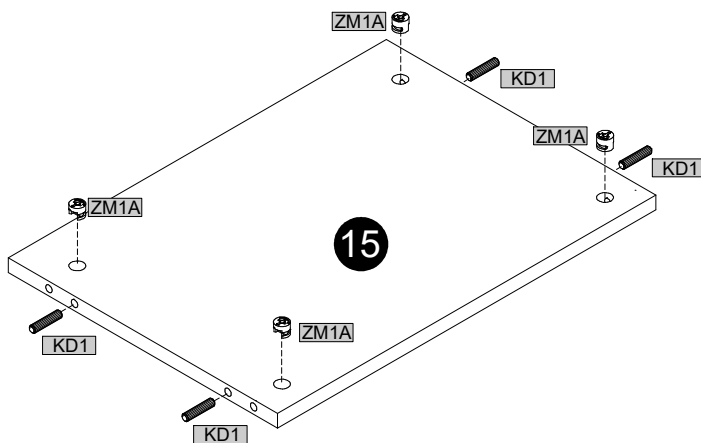

### 15

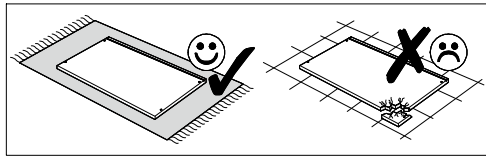

ZM1A	2	KD1	2	<del>KD2</del>	1

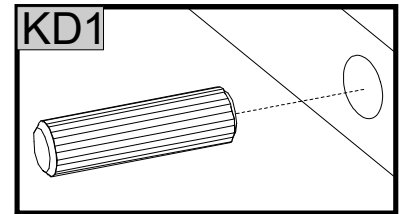
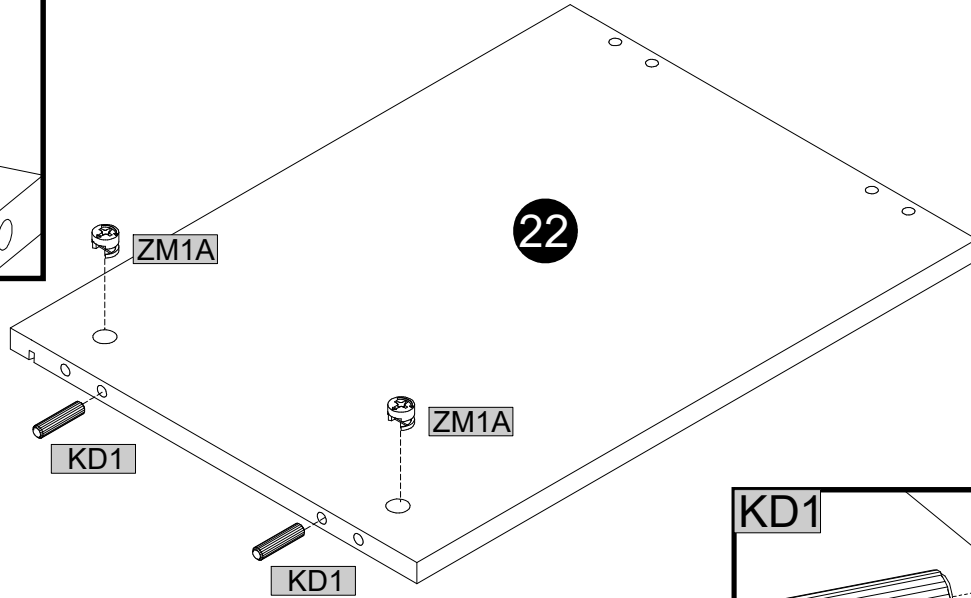
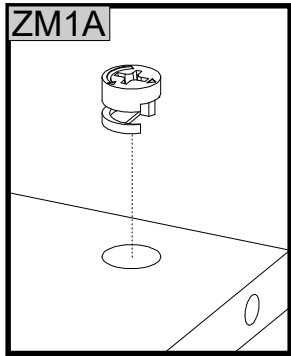

### 16

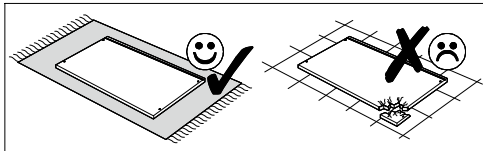

ZM1A	2	KD1	4	<del>KD2</del>	1

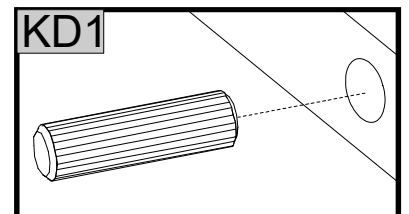
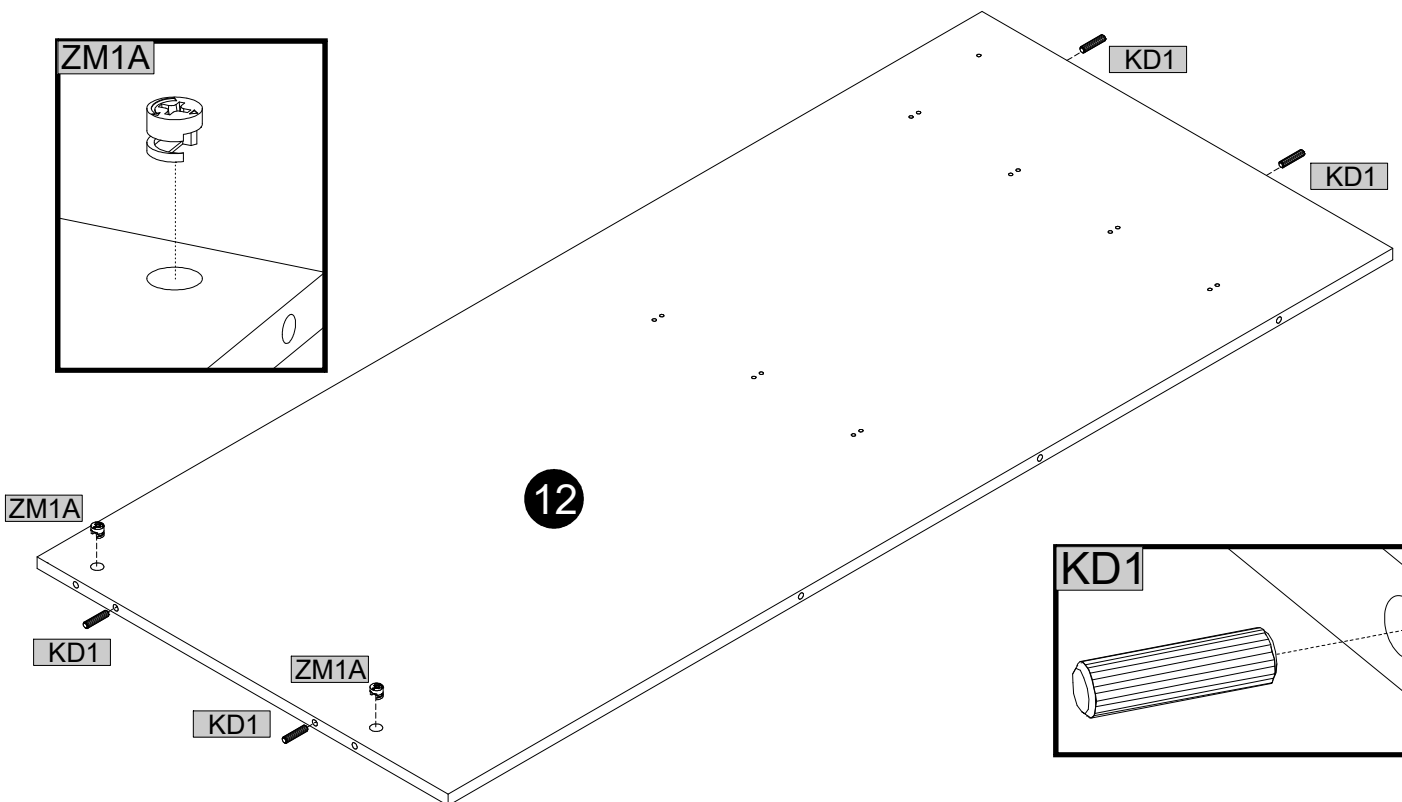
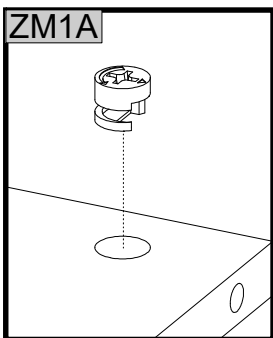

### 17

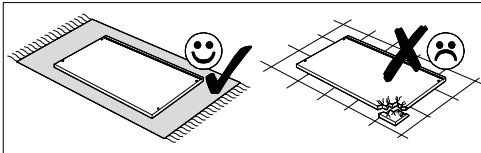

	ZM1B	4		ZM1A	2		KD2	2
	KD1	2		PQ4	1		PP	4
	W11	2		ZM1B	2		KD1	2
	KD1	2		PQ4	1		PP	4
	KD1	2		PQ4	1		PP	4
	KD1	2		PQ4	1		PP	4
	KD1	2		PQ4	1		PP	4
	KD1	2		PQ4	1		PP	4
	KD1	2		PQ4	1		PP	4
	KD1	2		PQ4	1		PP	4

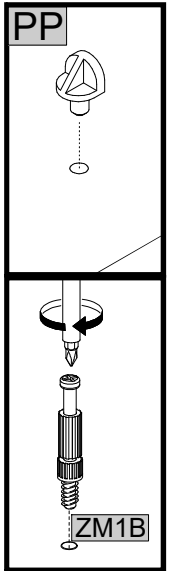
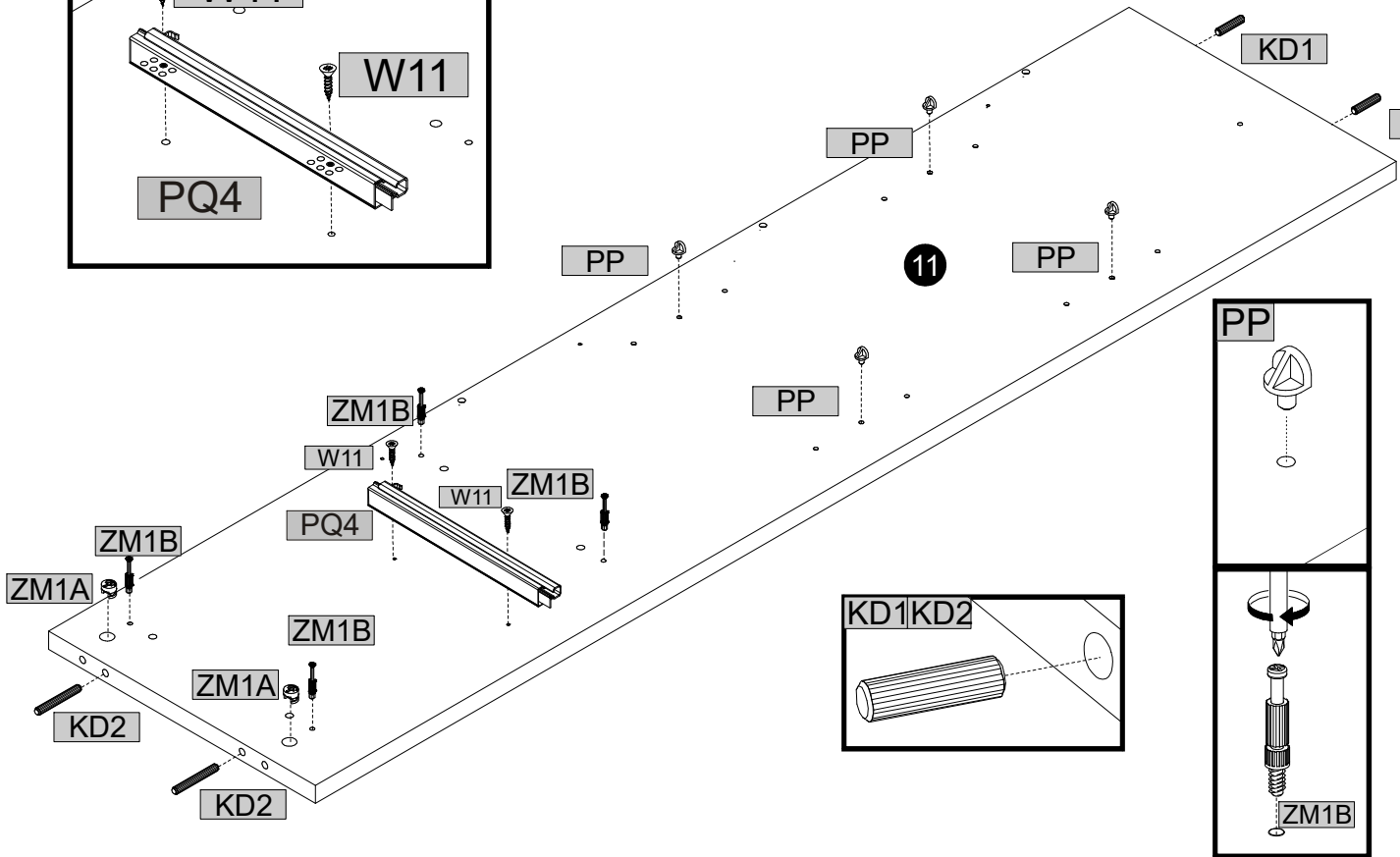
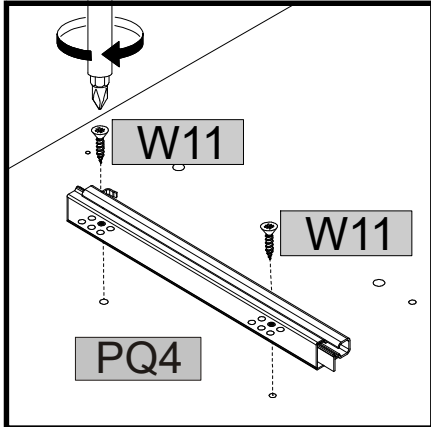

### 18

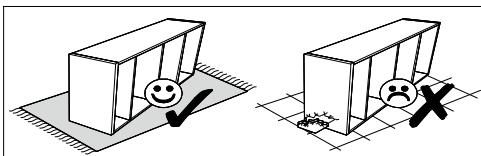

	KK1	1		ZM1	2
--	-----	---	--	-----	---

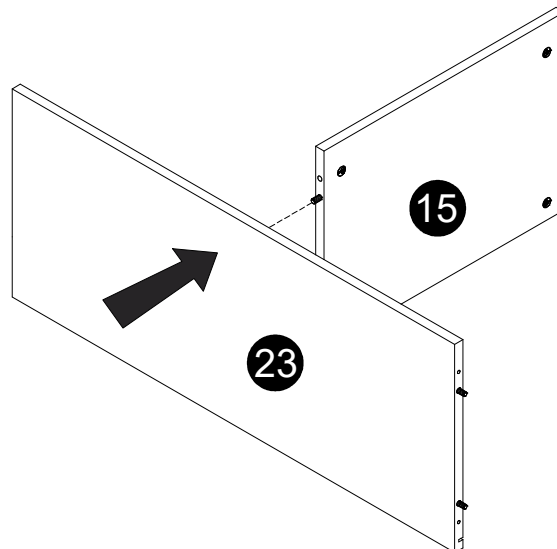
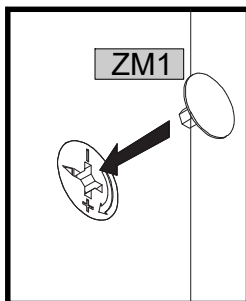
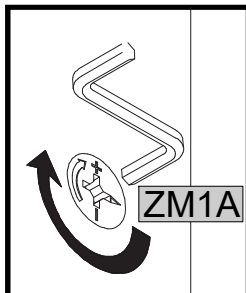

19

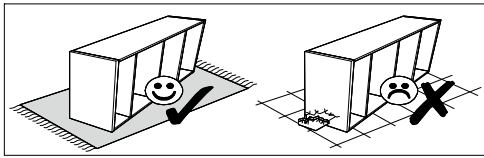

	2		1
ZM1		KK1	

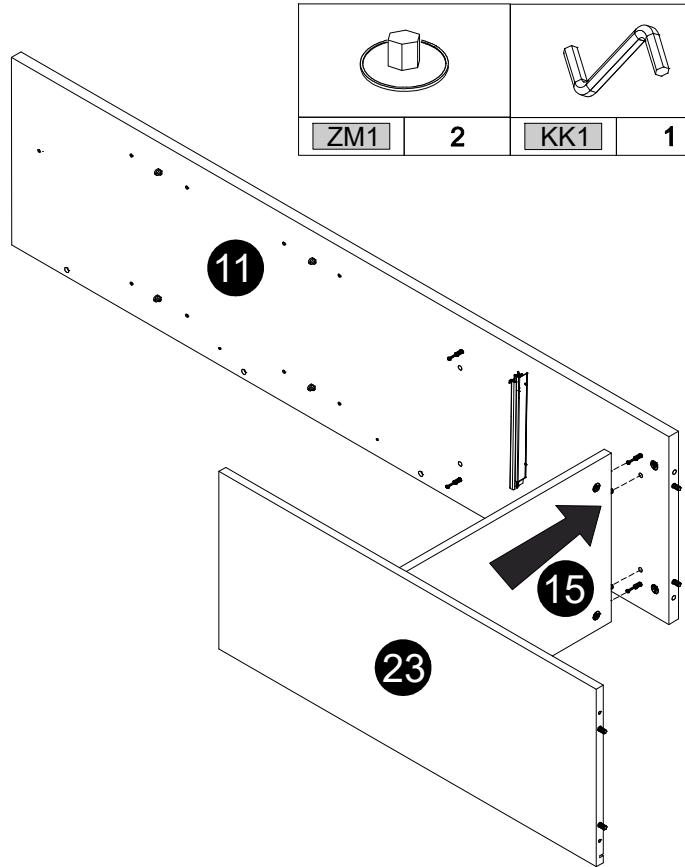
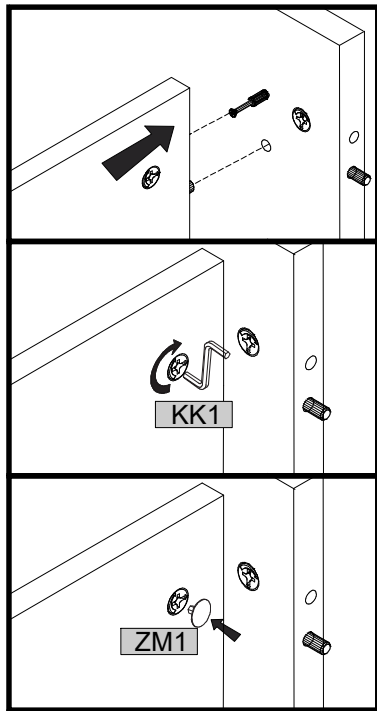

20

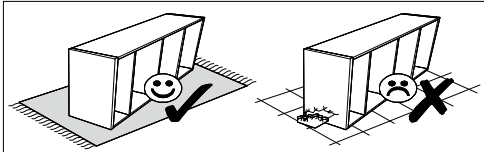

	2		1		2		1
K2		K1		ZM1		KK1	

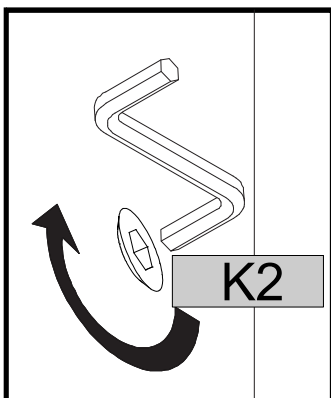
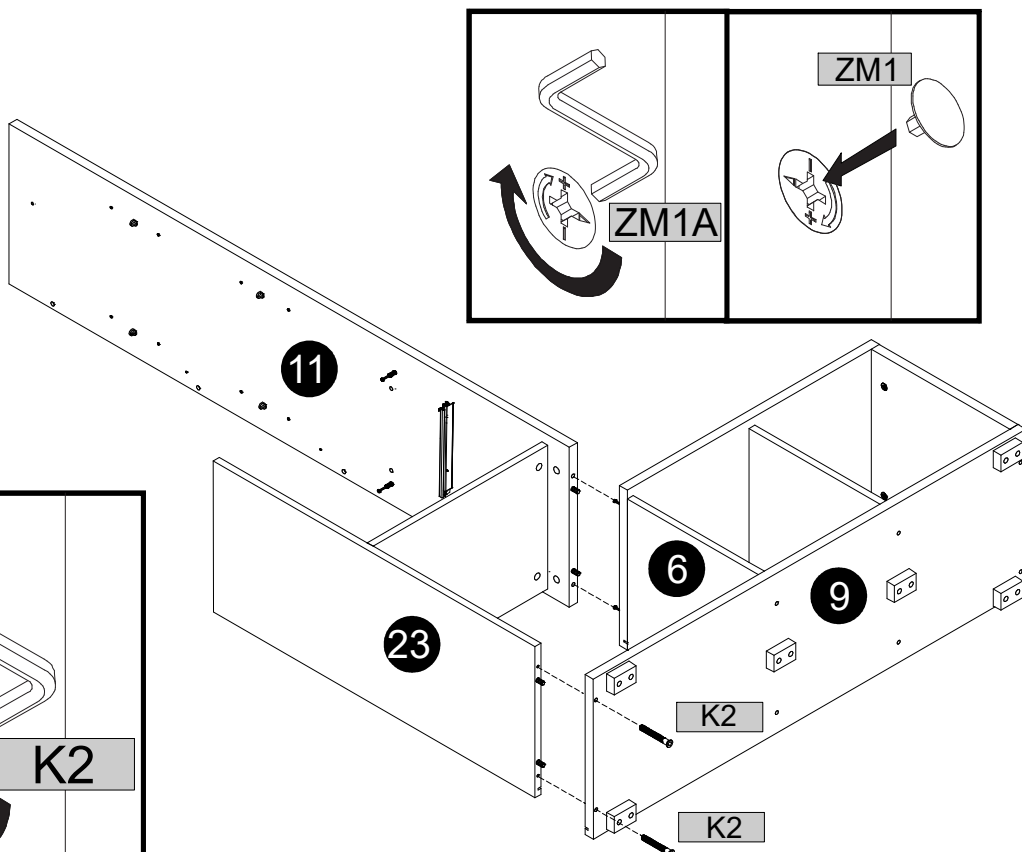

21

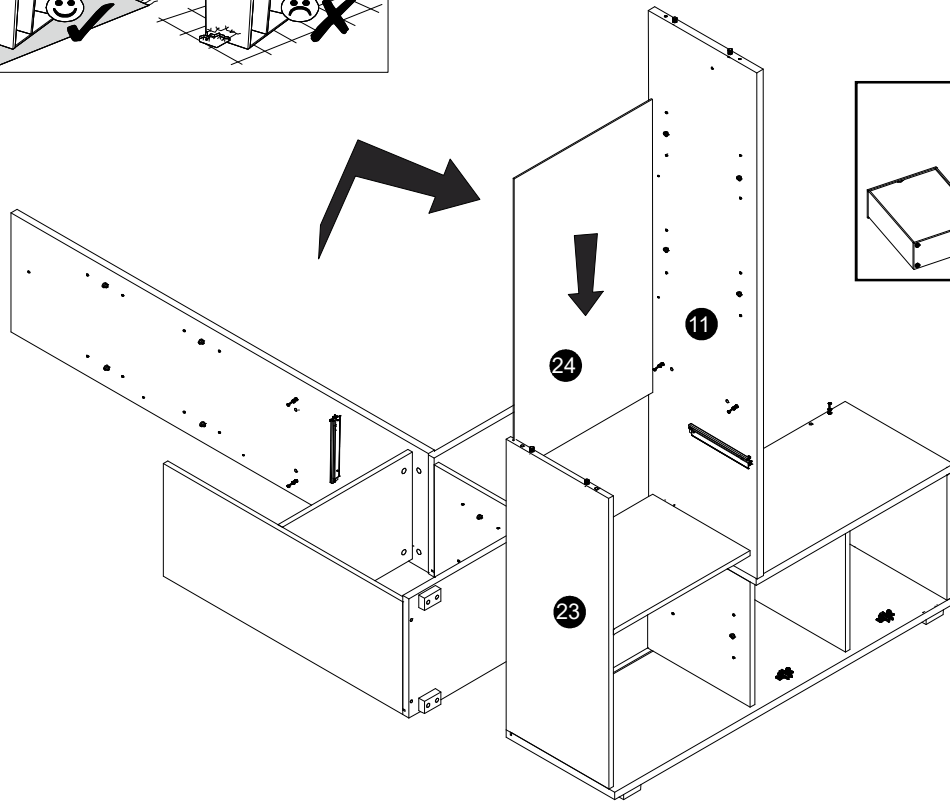
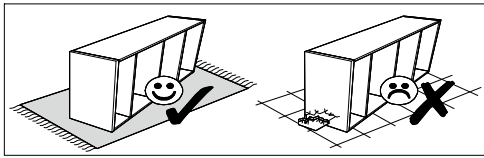

22

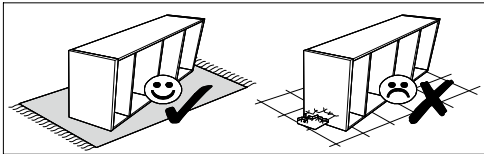

KK1	1
ZM1	2

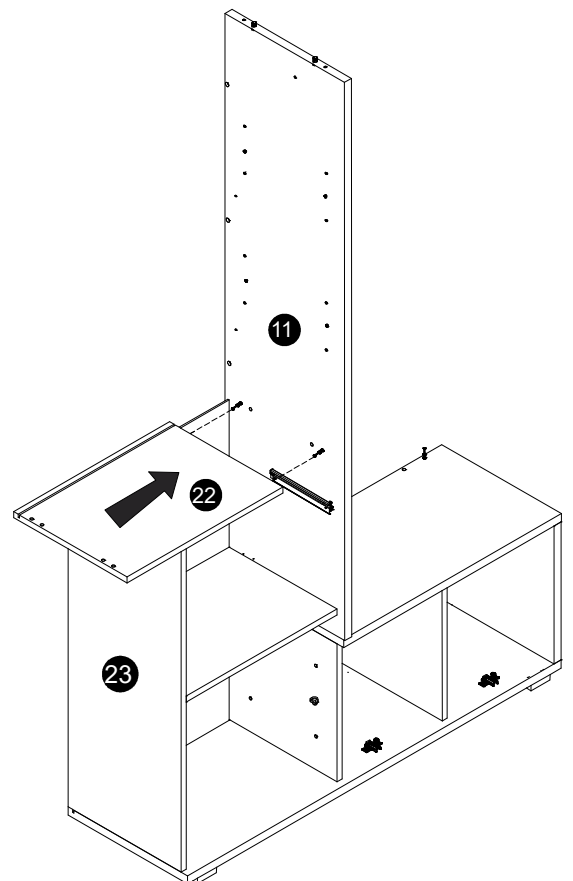
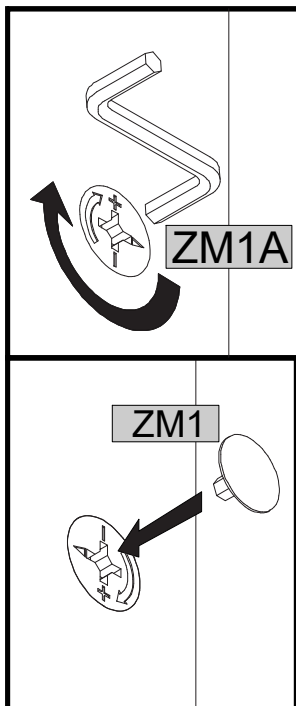

23

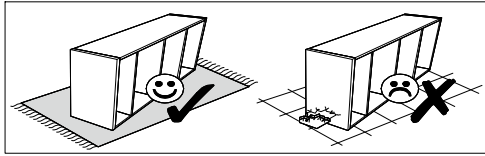

	8x60		L=86
<b>KD2</b>	2	<b>TPP3</b>	2

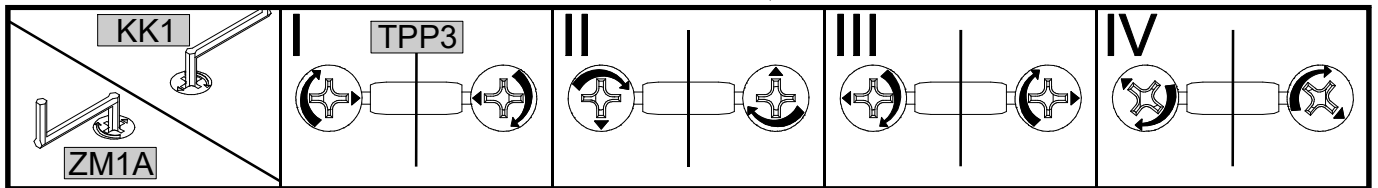
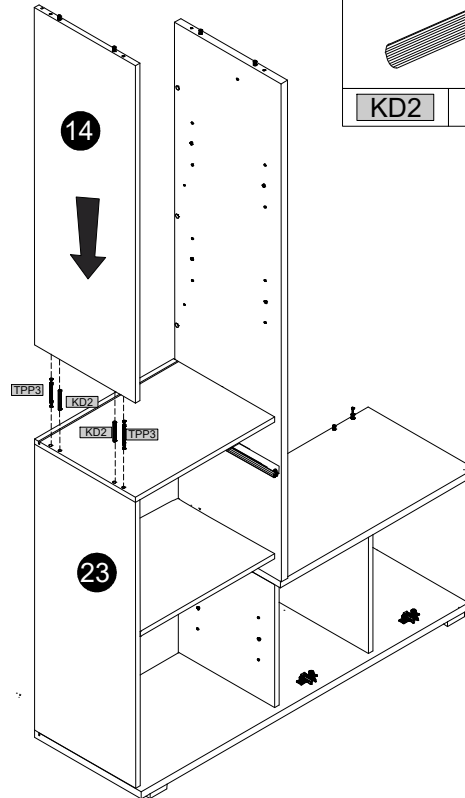
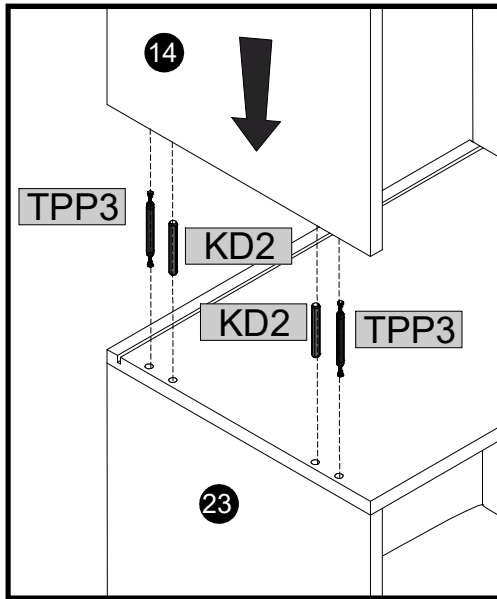

24

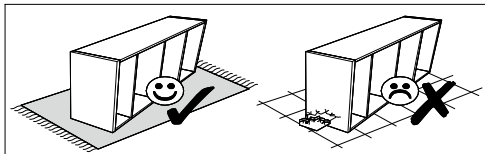

	7x70		7x50
<b>K2</b>		<b>K1</b>	3

<b>KK1</b>	1	<b>ZM1</b>	2

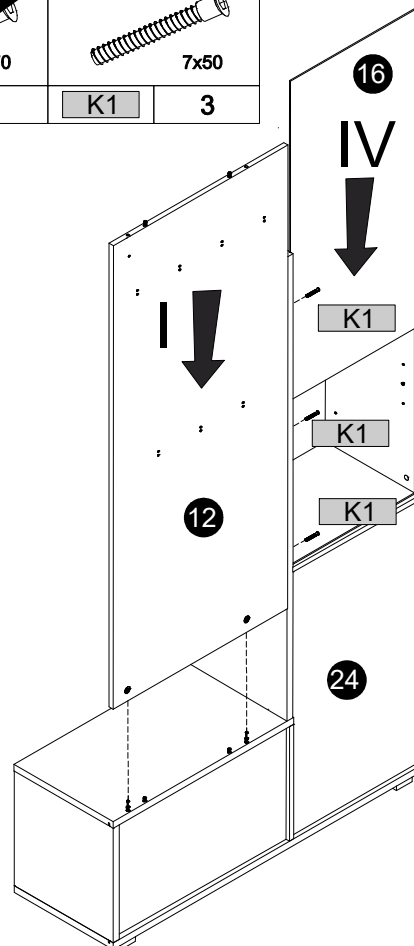
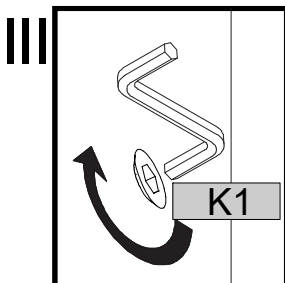
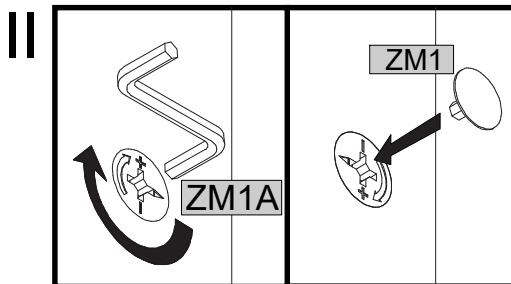

25

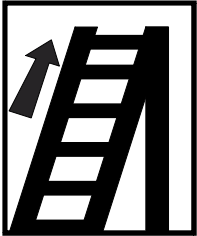
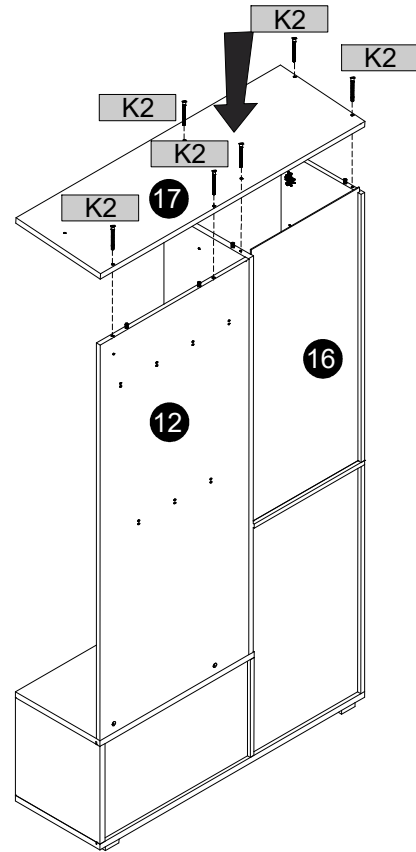
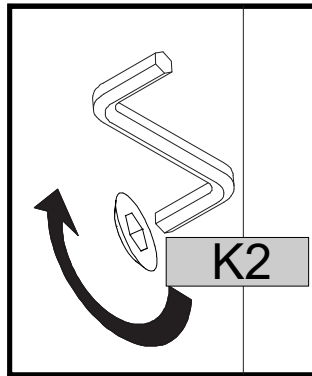
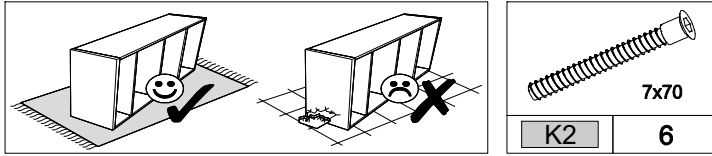

26

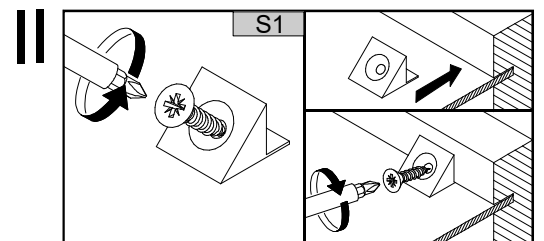
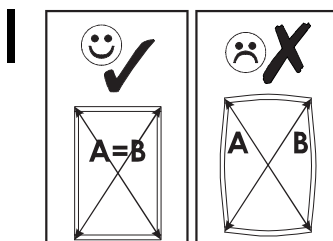
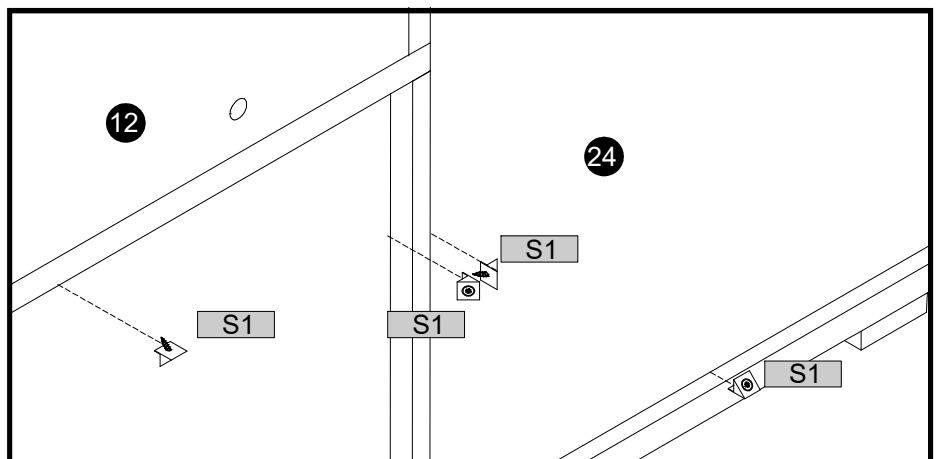
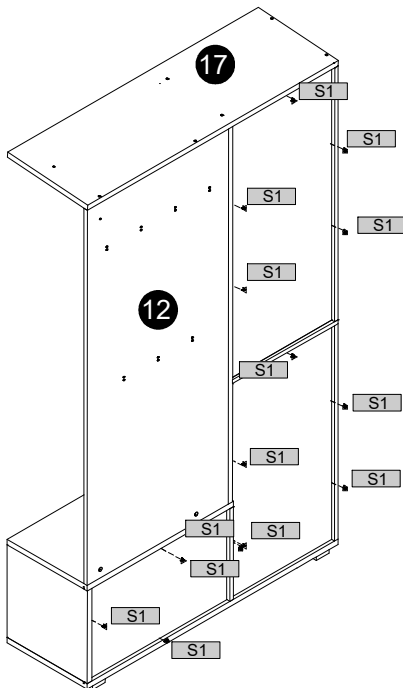
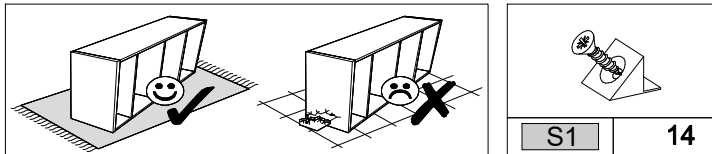



27

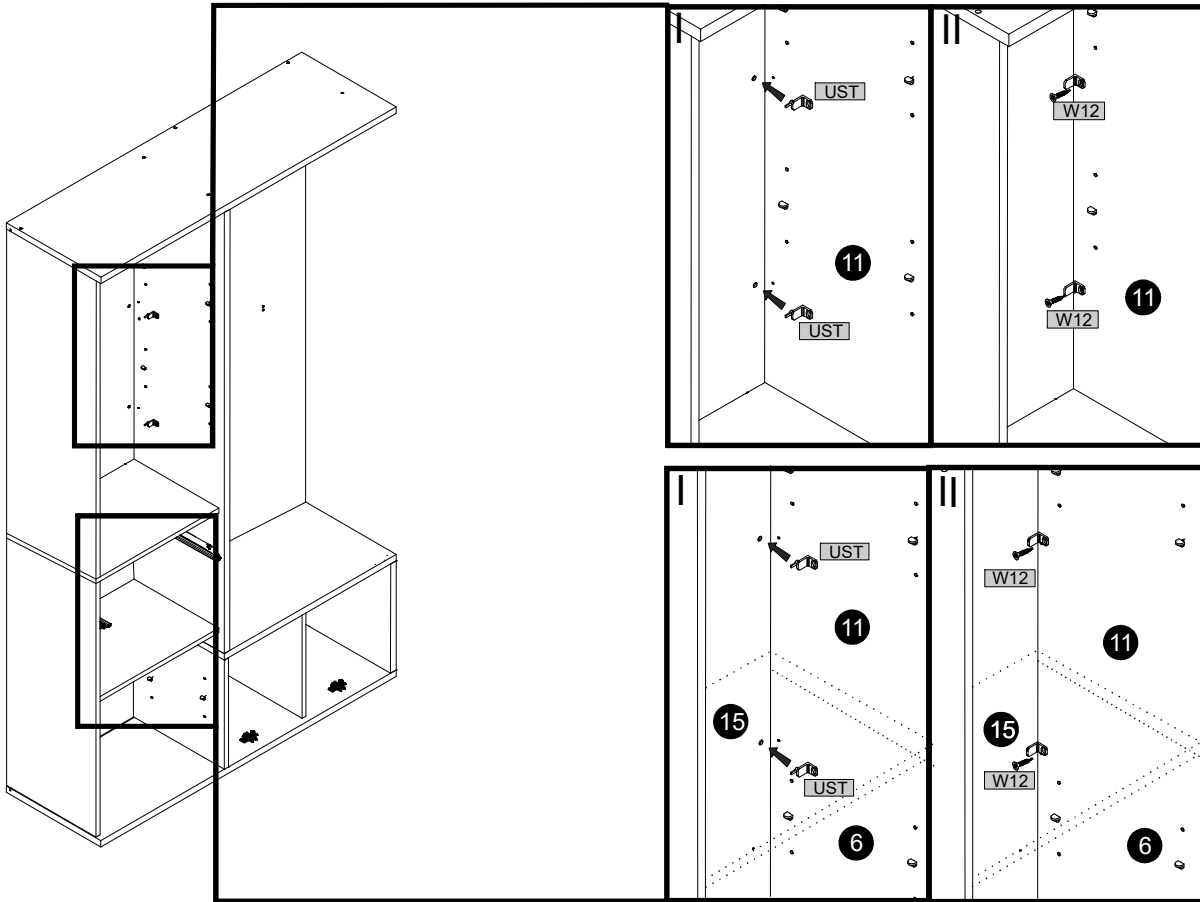
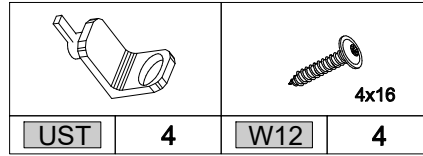
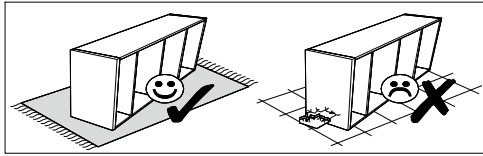

28

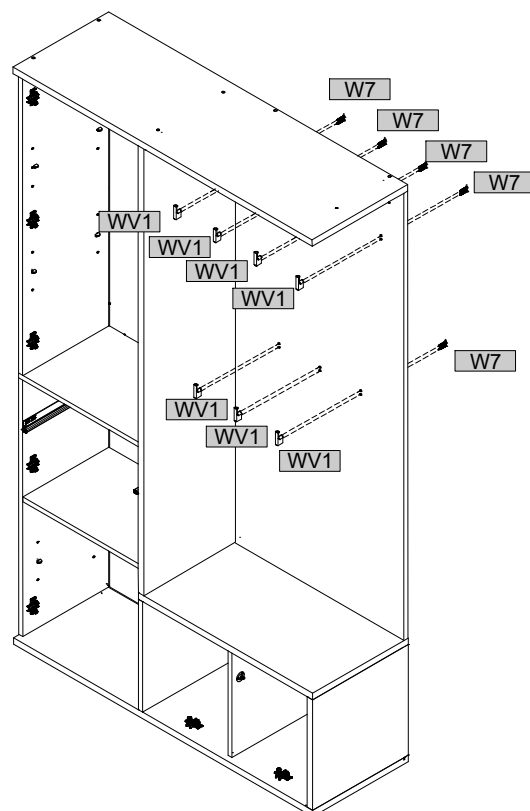
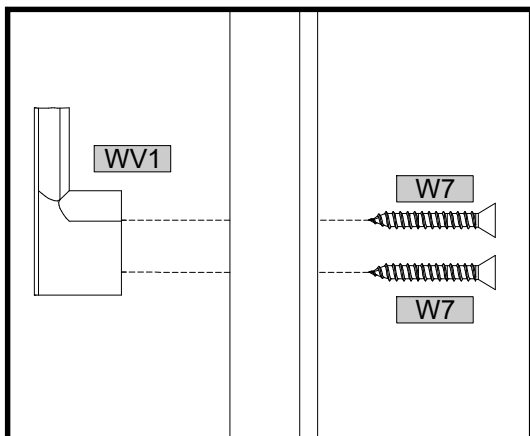
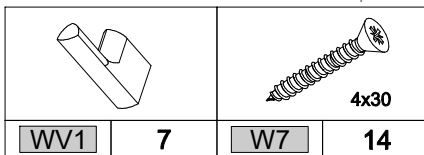
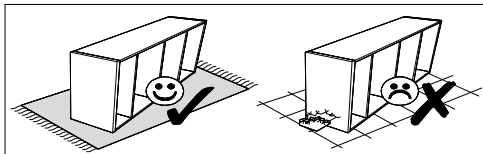

### 29

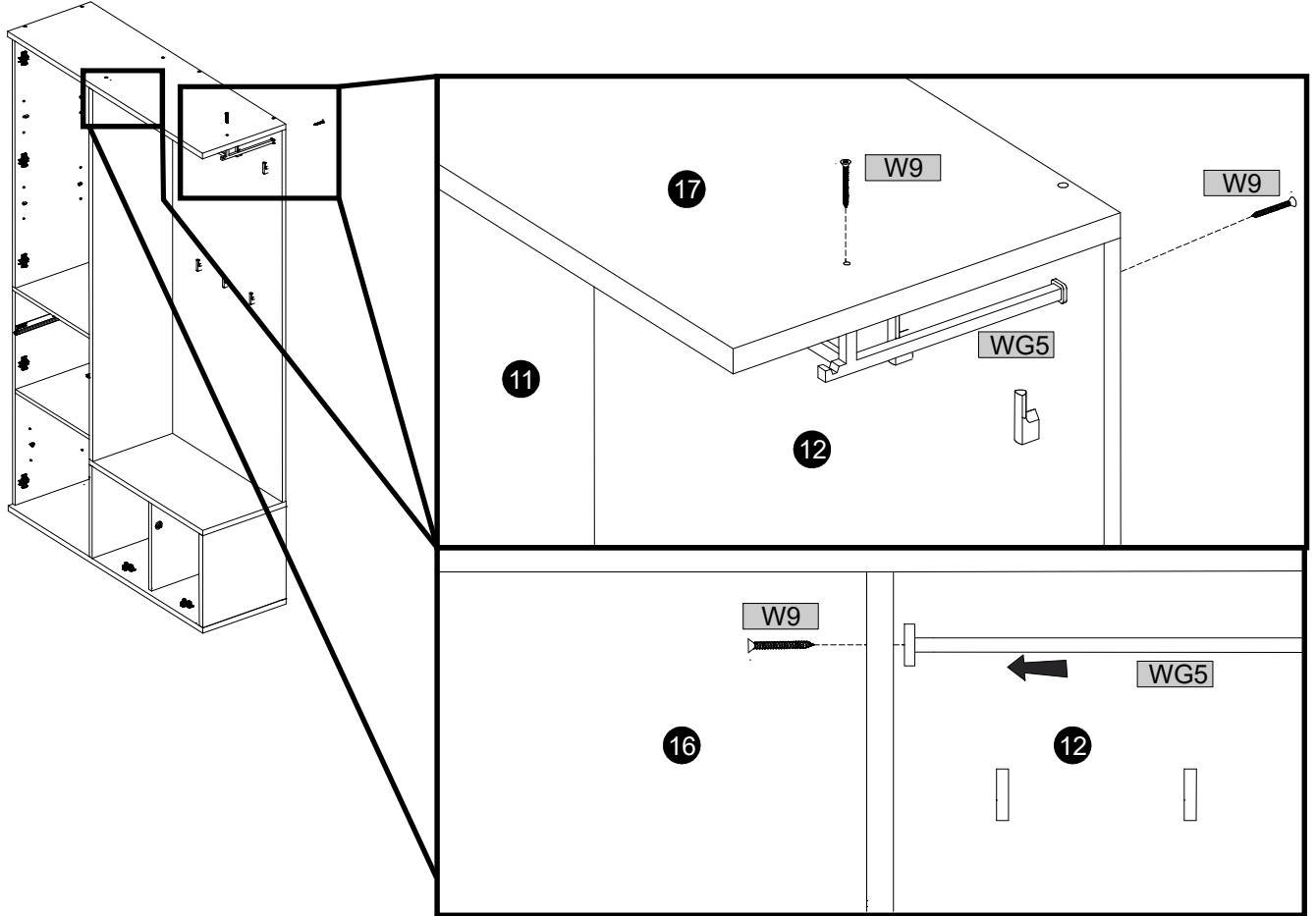
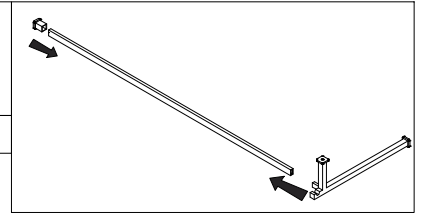
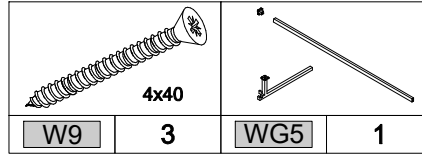
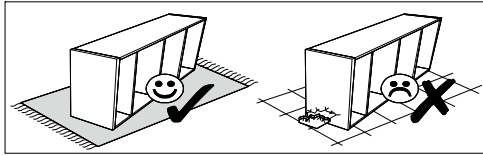

### 30

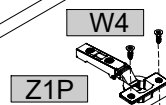
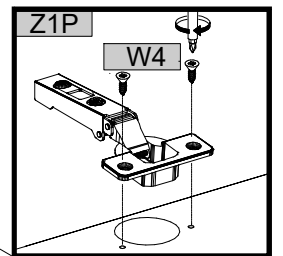
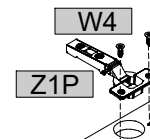
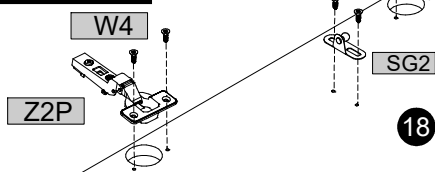
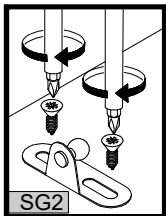
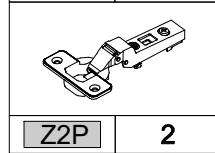
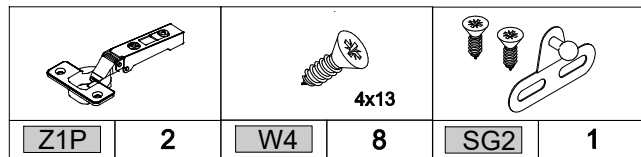
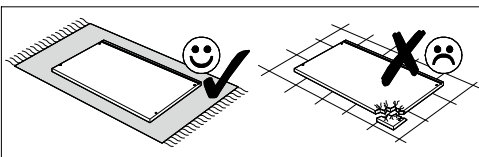

19



### 33

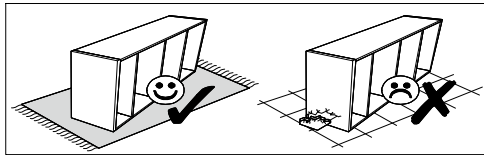

	1		2
		3,5x27	
			1

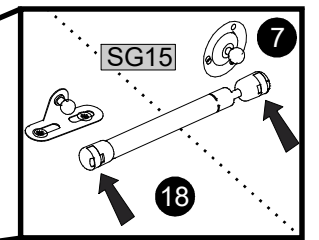
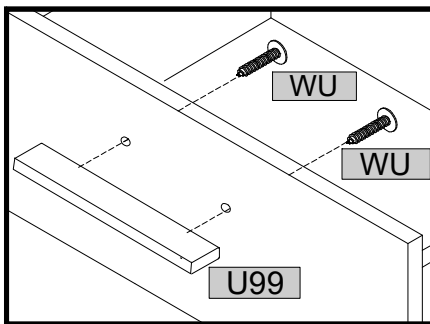
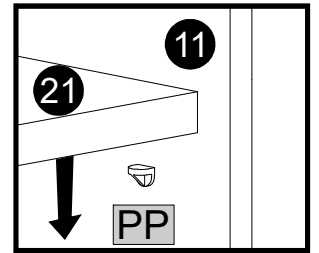
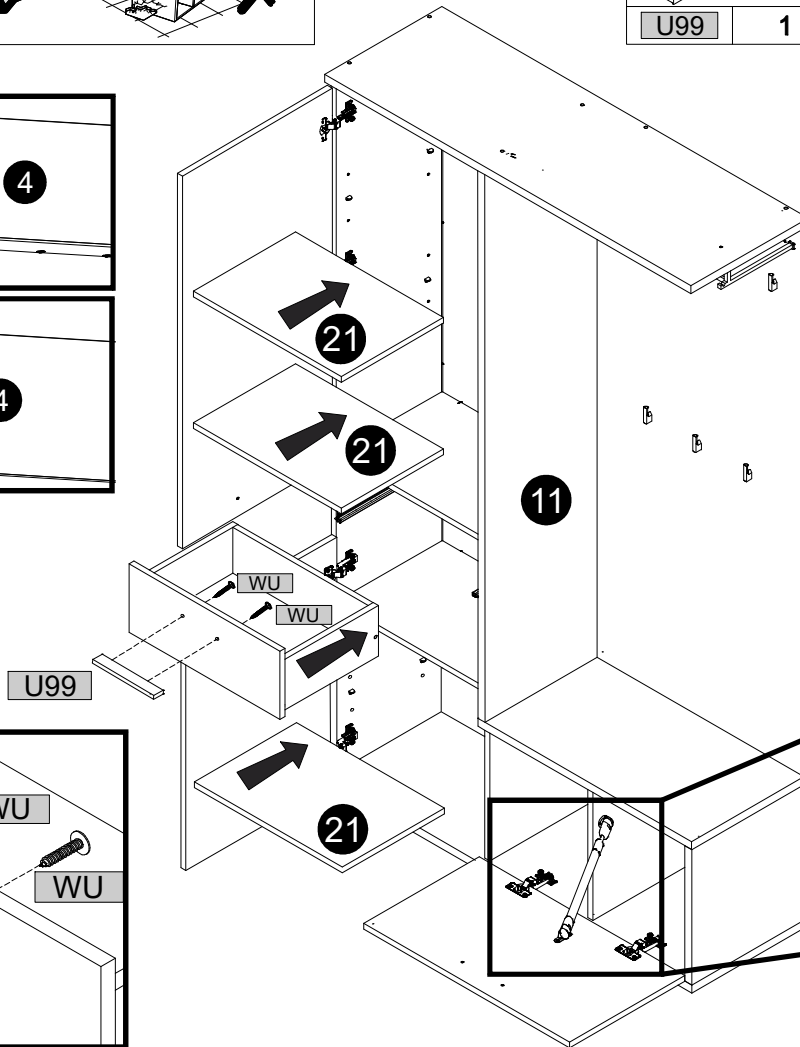
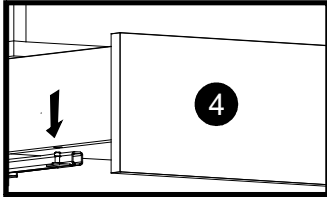
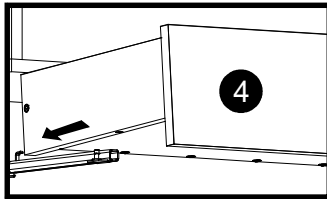

### 34

	2		2		4
		08x40		3,5x16	

