

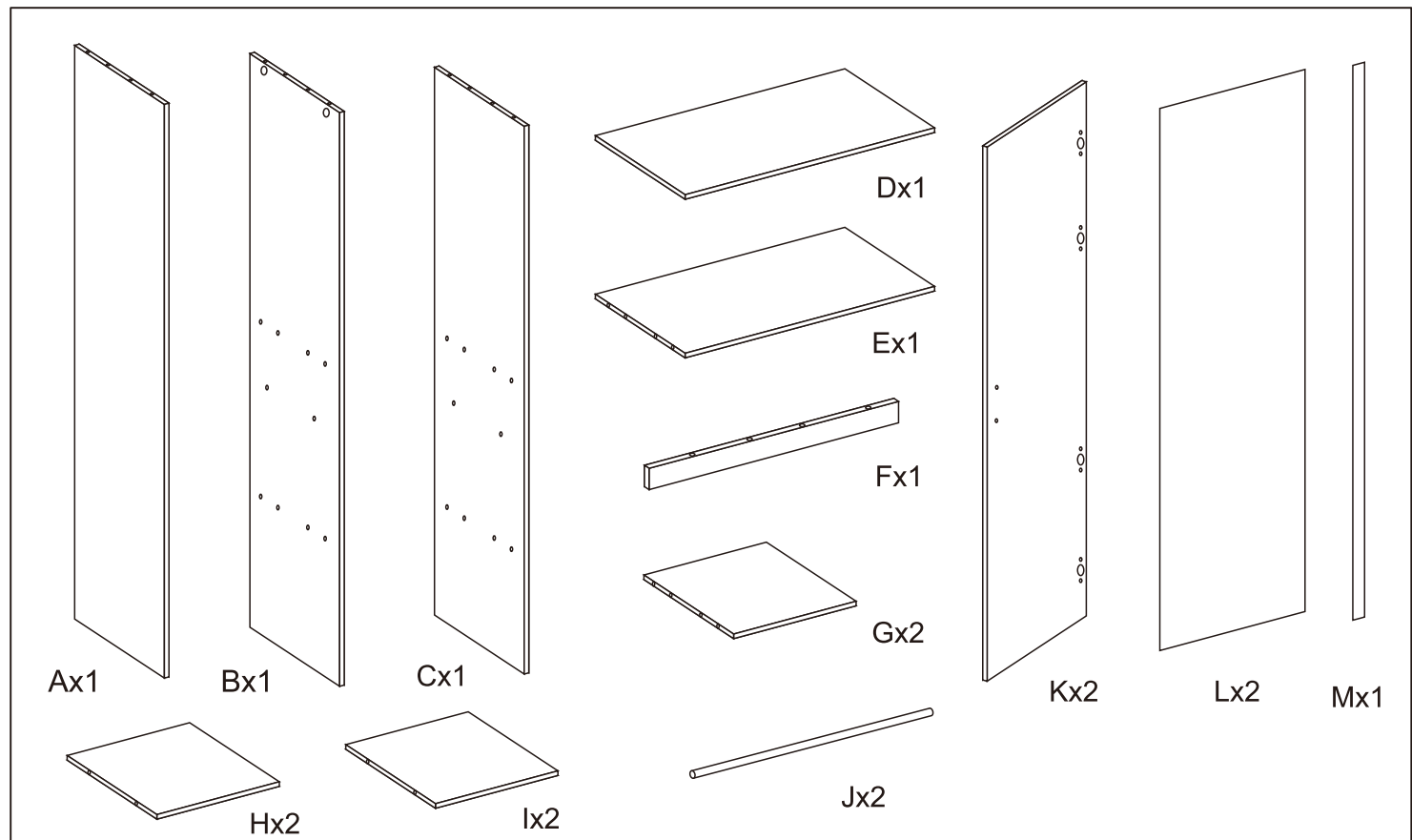

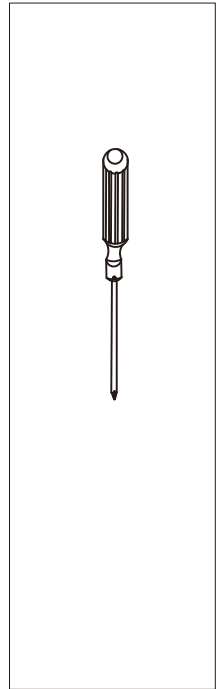

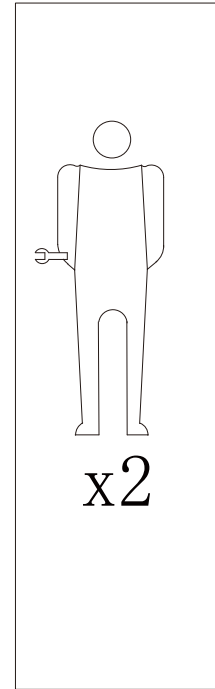

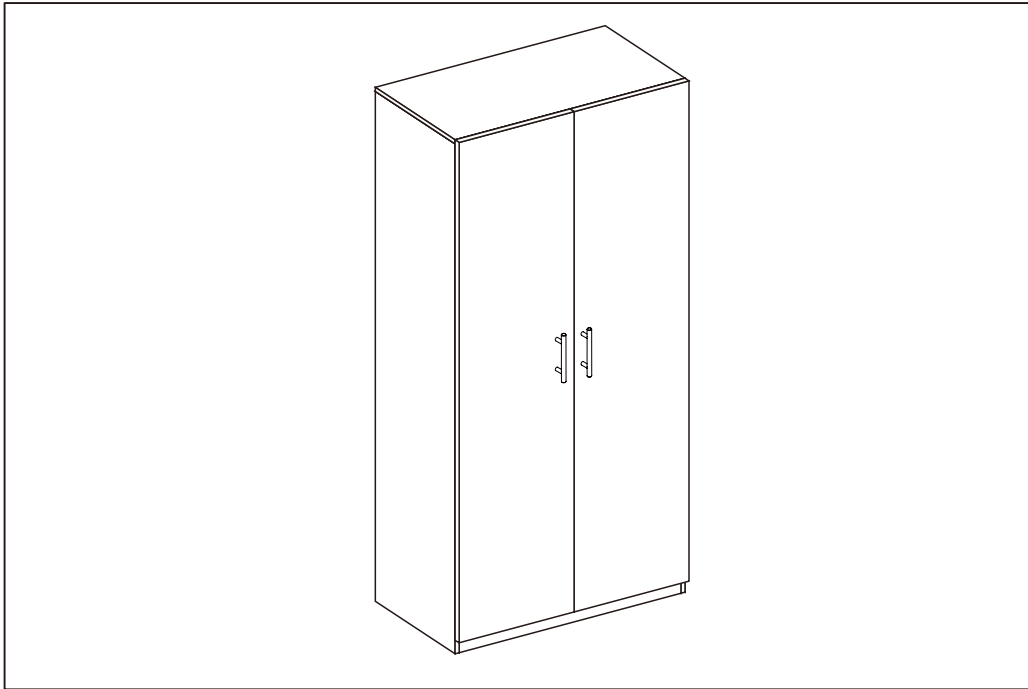











INSTRUCTION SHEET

22240011-03

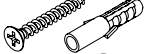

 ax28	 bx28	 cx24	 dx6	 ex48	 fx8	 gx24	 hx4
 ix6	 jx2	 kx4	 lx4	 mx8	 nx2	 ox2	 px2
 qx2	 rx8						

Step 1

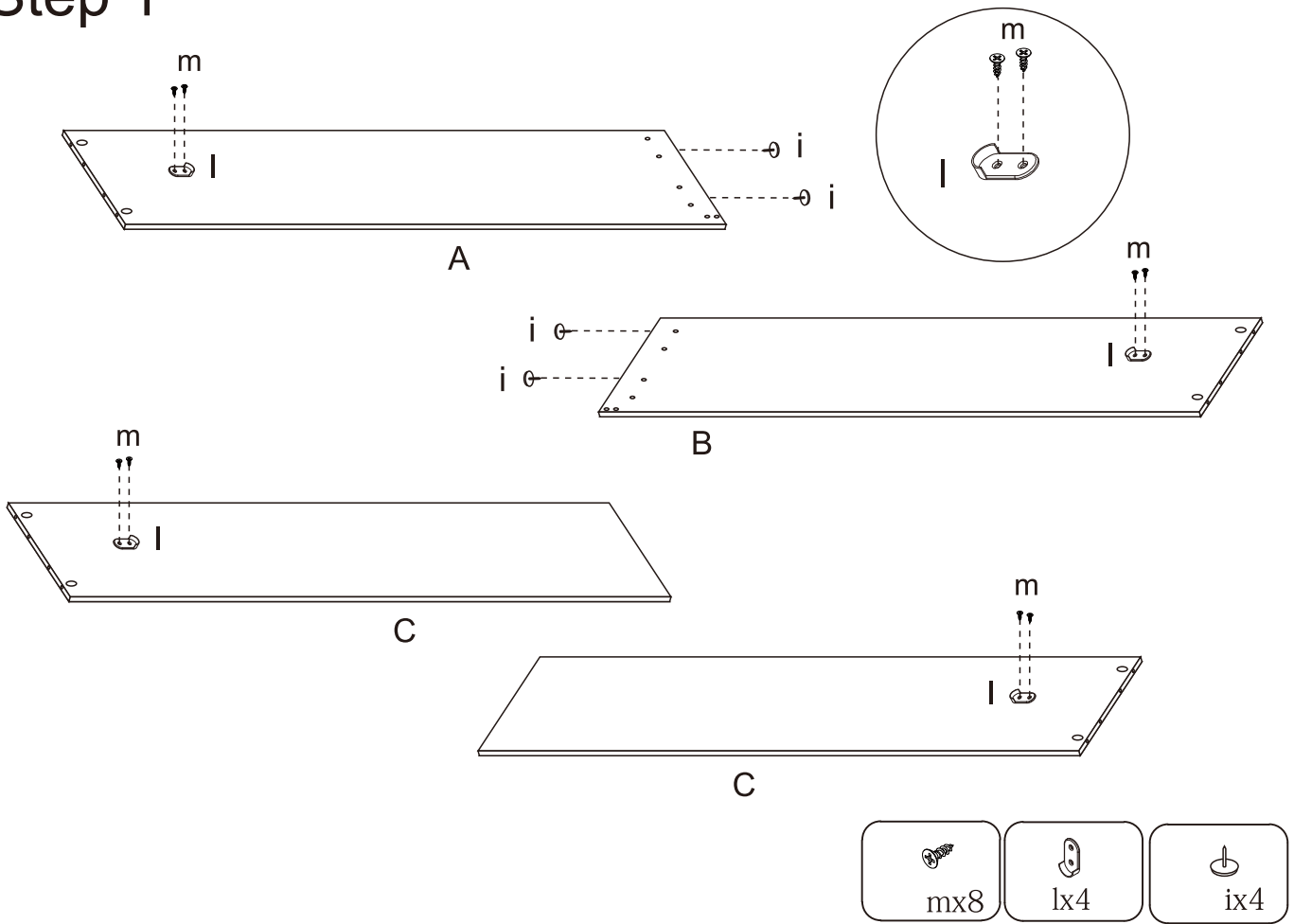

Step 2

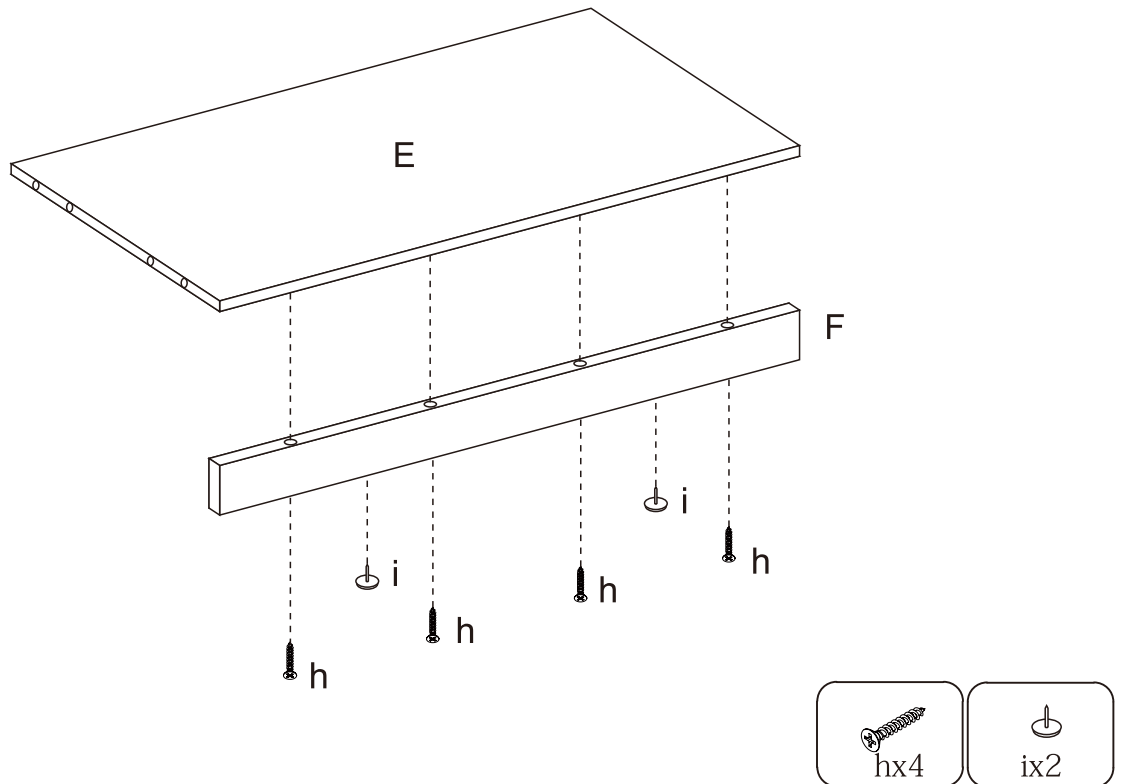

Step 3

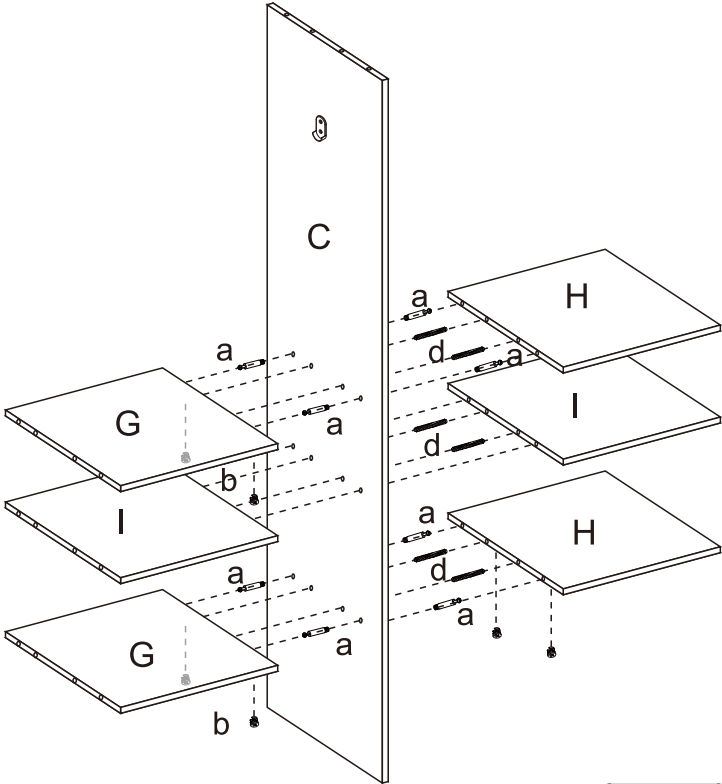

Step 4

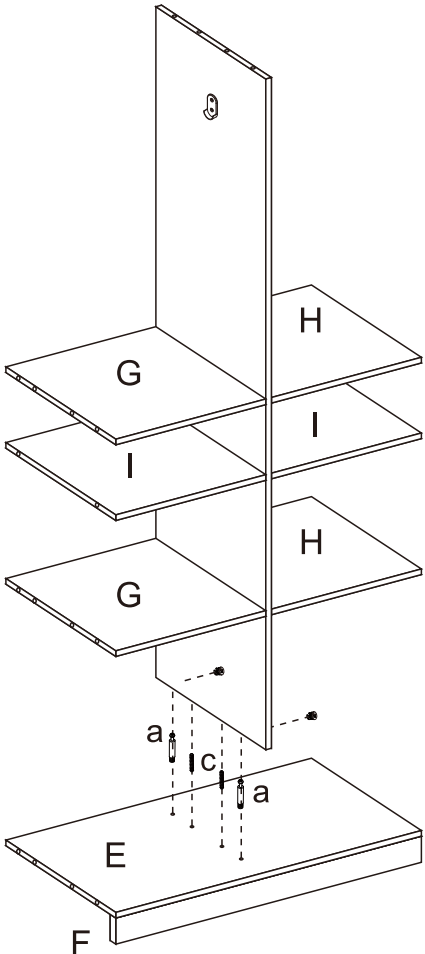



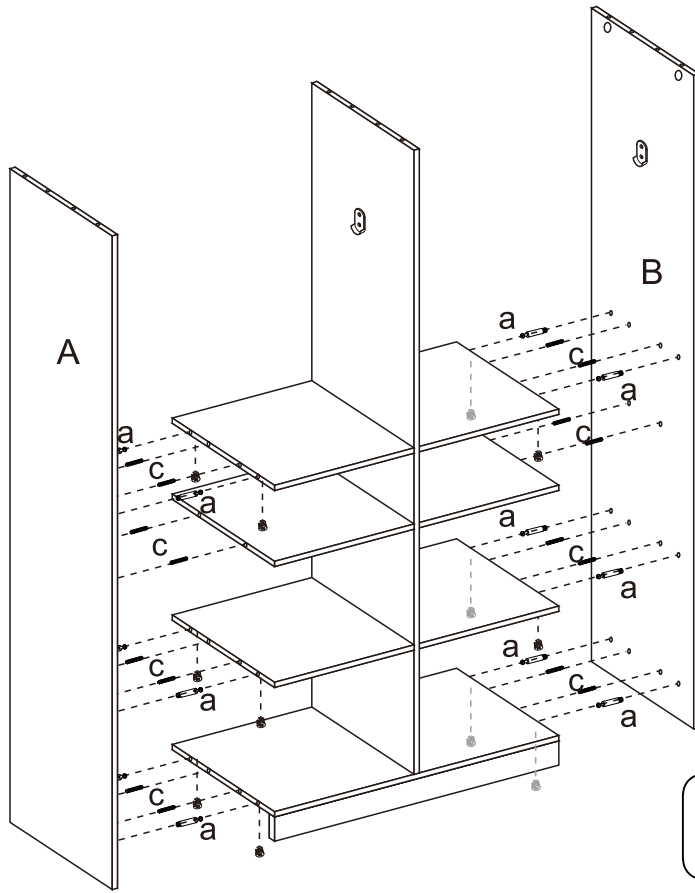

Step 5

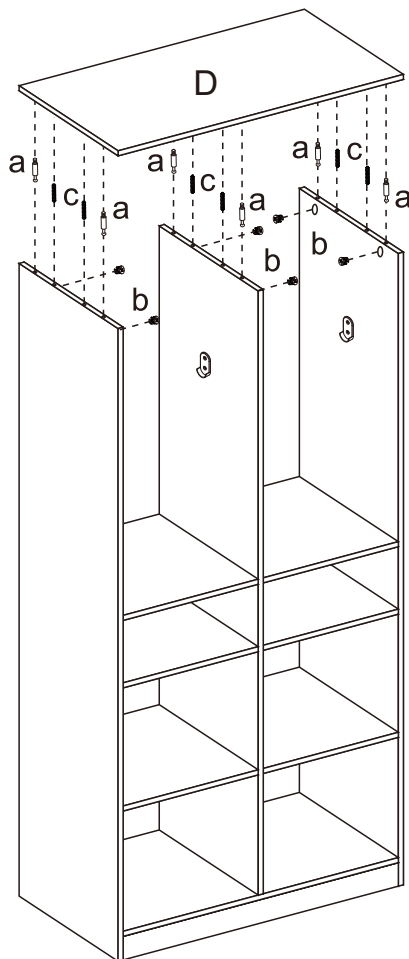

 ax12	 bx12	 cx16
---	---	---

Step 6



 ax6	 bx6	 cx6
--	--	--

Step 7

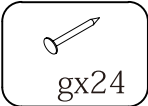
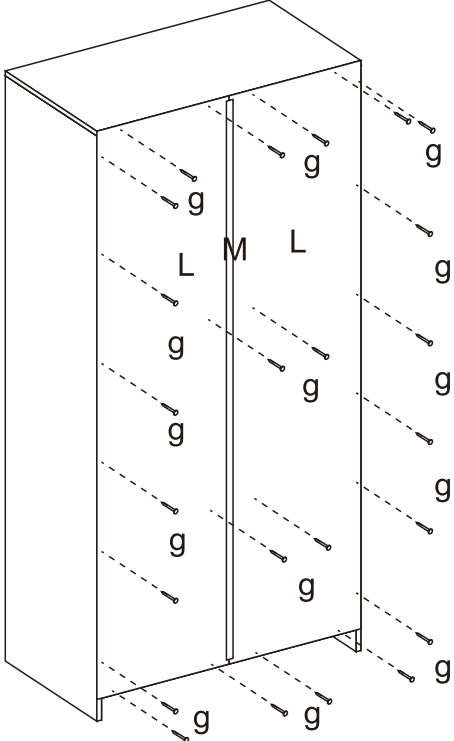

Step 8

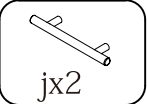
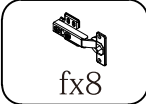
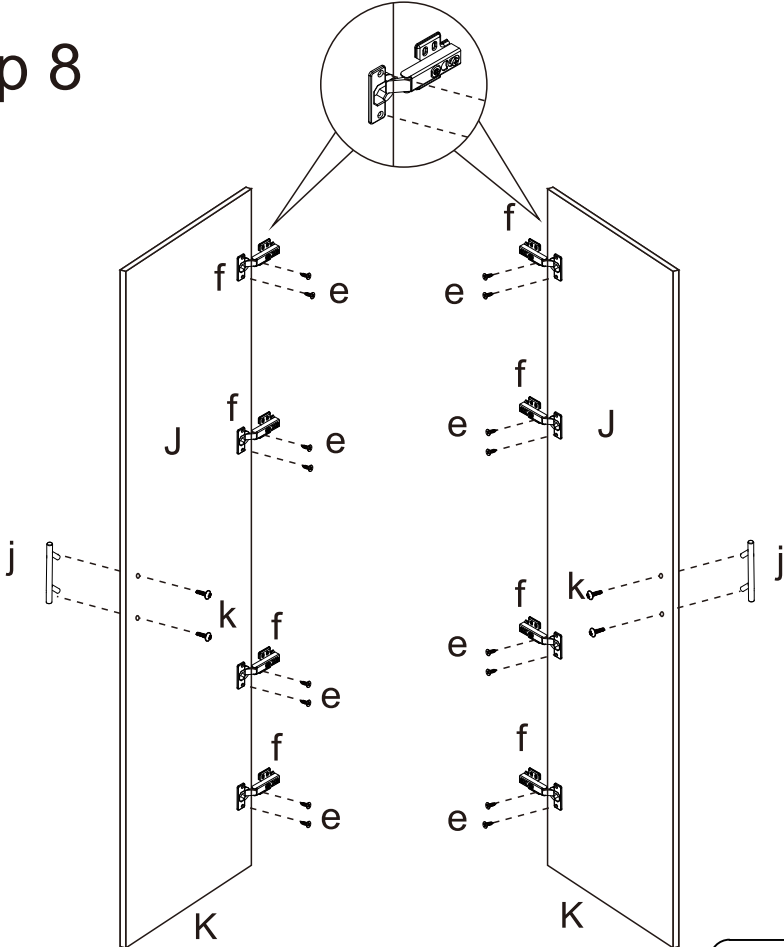

Step 9

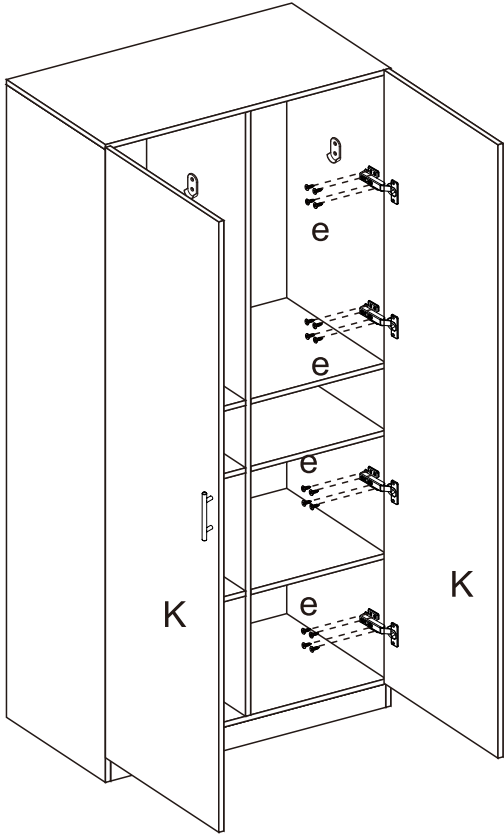

Step 10

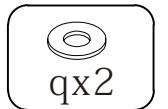
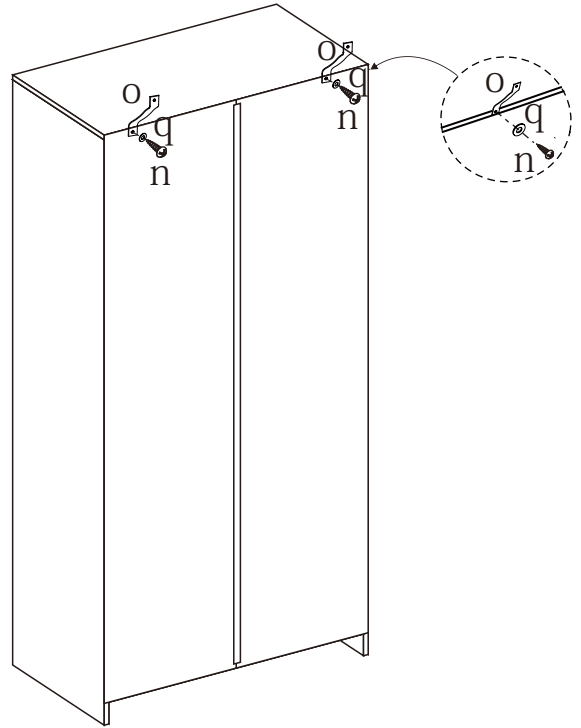

Step 11

