













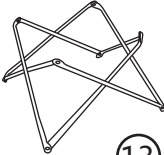

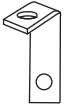
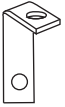
Rockville

		 ⑪ x1	 ⑫ x4	 ⑬ x1	 A x2
 B x1	 C x1	 M6x35mm D x8	 M6 E x8	 M6 F x8	 M6x15mm G x4
 M6 H x4	 M6 I x1	 M6 J x1			

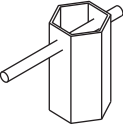

- (D) Bitte überprüfen Sie in regelmäßigen Abständen den festen Sitz der Schrauben!
- (GB) Please check the screws for tightness at regular intervals!
- (F) Veuillez contrôler régulièrement que les vis sont convenablement serrées !
- (ES) ¡Compruebe periódicamente que los tornillos estén bien apretados!
- (IT) Controllare regolarmente che le viti siano ben strette!
- (PL) Należy regularnie sprawdzać dokręcenie śrub!
- (NL) Controleer op regelmatige afstanden of de schroeven goed vast zitten.
- (SWE) Kontrollera med jämna mellanrum att skruvarna sitter fast ordentligt!
- (SK) V pravidelných intervaloch kontrolujte pevné dotiahnutie skrutiek!
- (SL) Redno preverjajte, ali so vijaki trdno priviti!
- (HR) Redovito provjeravajte čvrsto nalijeganje vijaka!

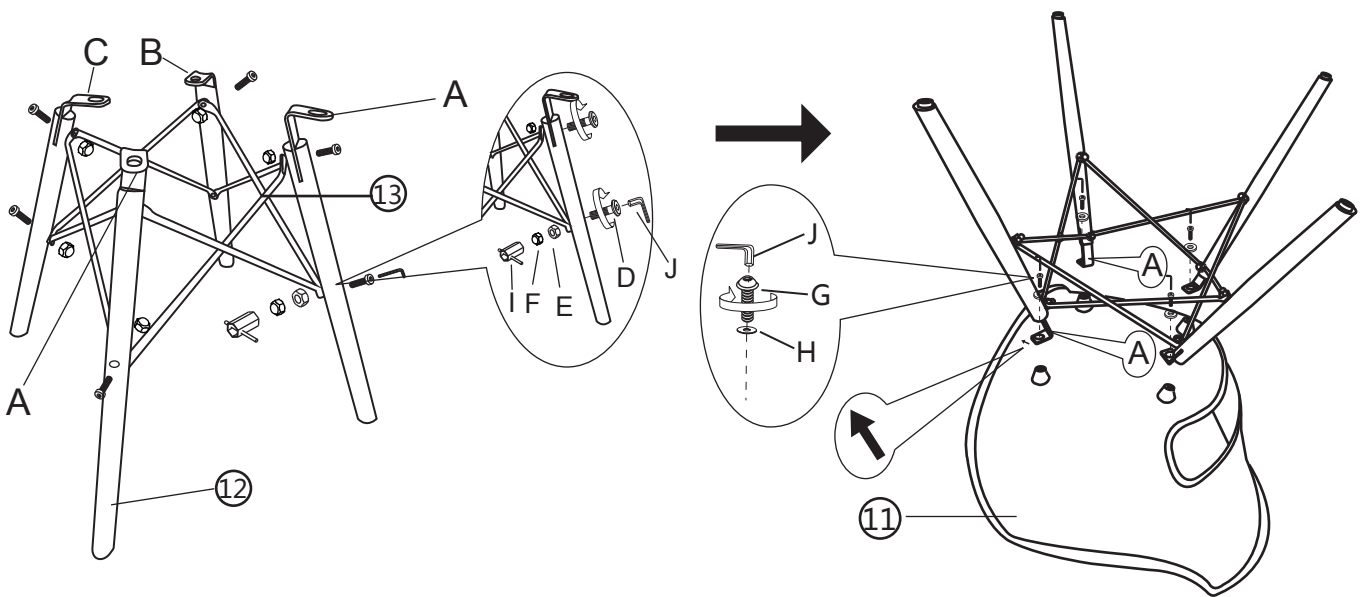
MCA
Furniture

